

**Field Tools  
for Gen2 Model**

**Spare Parts Leaflet**

**03-FAA27EV**

**November 2003 / Page 1 of 5**

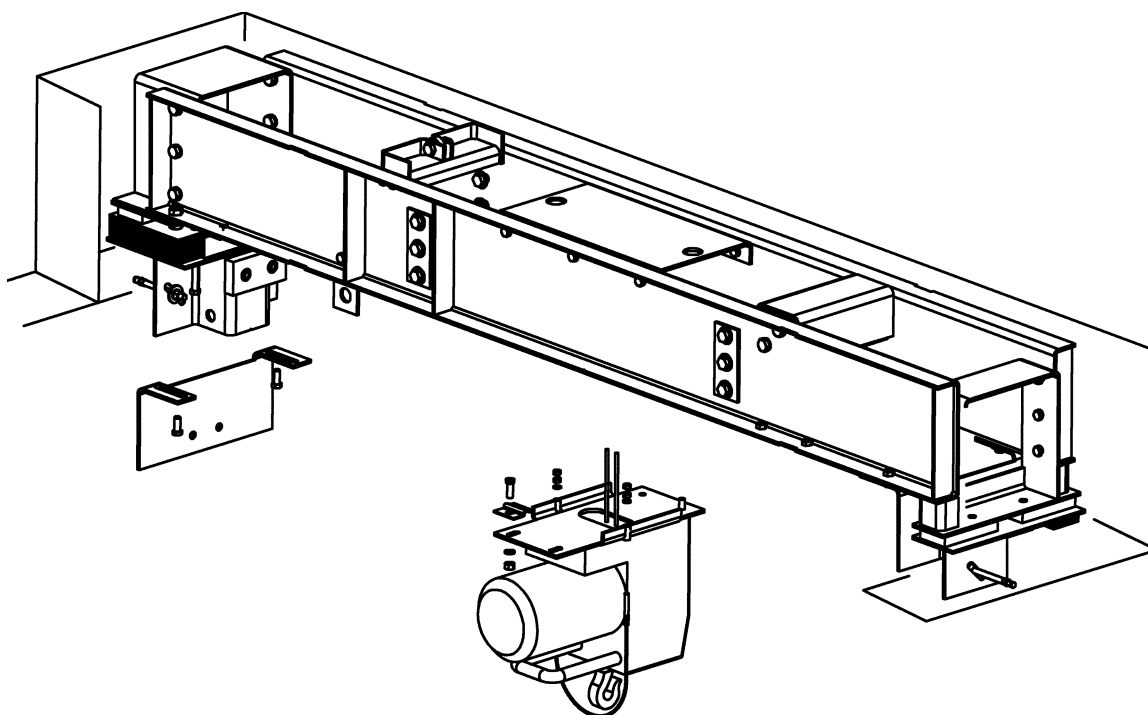

Unpublished Work—© Otis Elevator Co.; 2003

**OTIS**

**Safety First!**

**SERVICE ENGINEERING**

**Otis Elevator Company**

**Bloomfield, Connecticut USA**

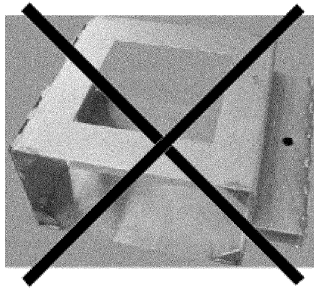

=

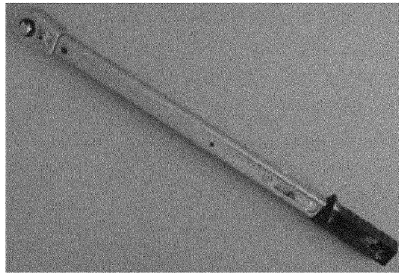
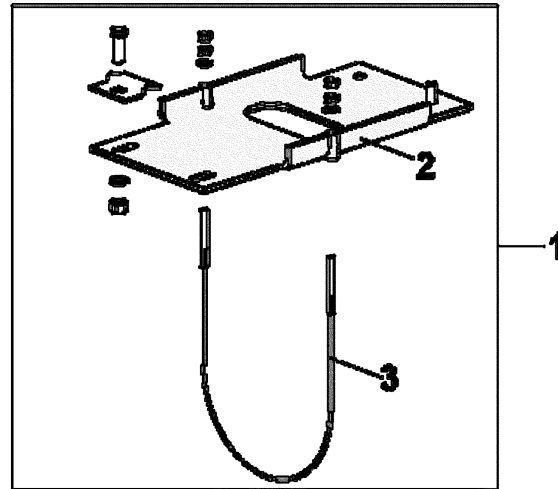

4

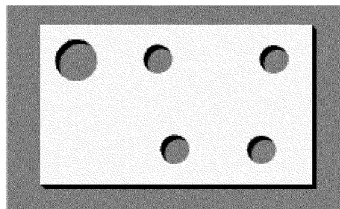
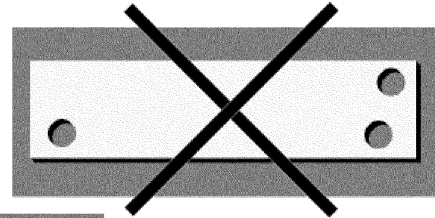

5

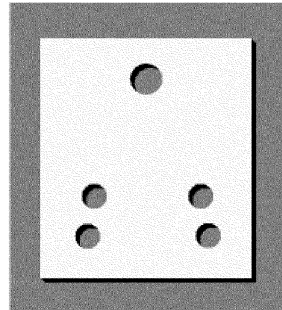

6

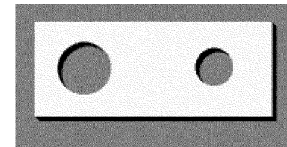

7

**FAA27EV  
FBA27EV**

REF. No.	PART No.	DESCRIPTION
1	<del>FAA27EY4</del> FAA5390A20	Kit of Winch Plate (ISO4017M12x35-8.8-Y+4; ISO4032M8-8-Y+2; ISO7089-M8-140HV-Y+FAA339BL1+DIN7991M12X30-8.8Y+FAA27FR1+FAA712AL1)
2	FAA27FR1	Winch Plate
3	FAA712AL1	Cable for Winch Plate
4	FAA27ES1	Torque Wrench
5	FBA27EE1	Bracket for Car Rails & Dead End Hitch
6	<del>FCA27DY4</del> FDA27DY1	Bracket for Car Rails Suspension
7	<del>FAA27ED4</del> FBA27ED1	Bracket for Hoist Suspension

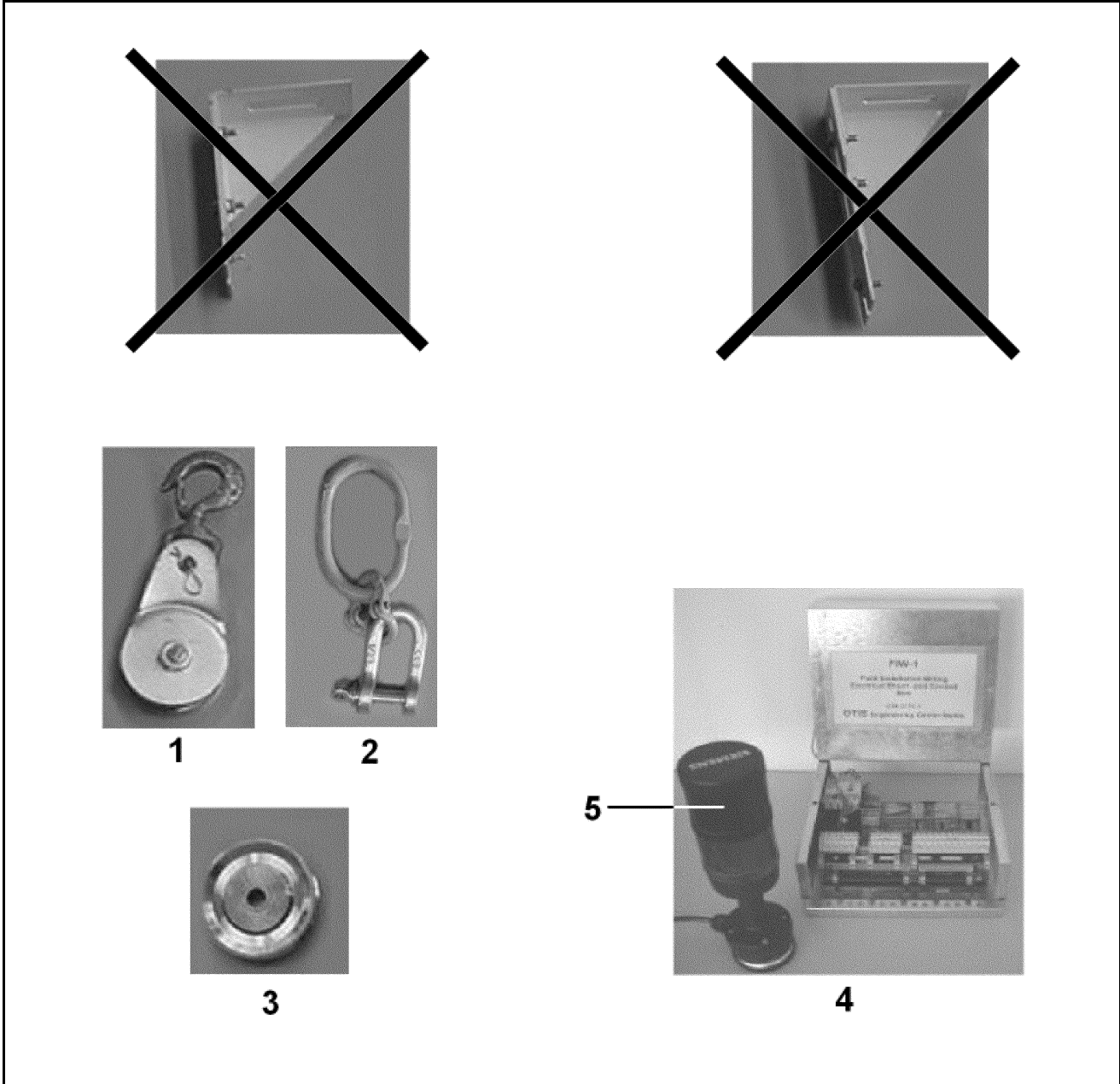

<b>FAA27EV FBA27EV</b>		
<b>REF. No.</b>	<b>PART No.</b>	<b>DESCRIPTION</b>
1	FAA198Z1	Pulley with Hook
2	FAA263FB1	CWT Lifting & Suspension Device
3	FAA263Y1	Pulley
4	<del>GAA27FE1</del> GAA27FL1	Field Shunt & Alarm Bell
5	GAA731E1	Alarm Bell

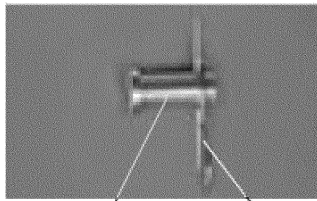

1a 1b

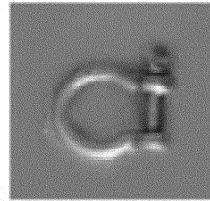

2

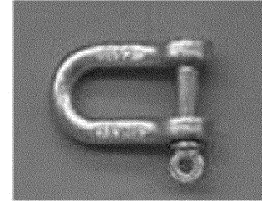

3

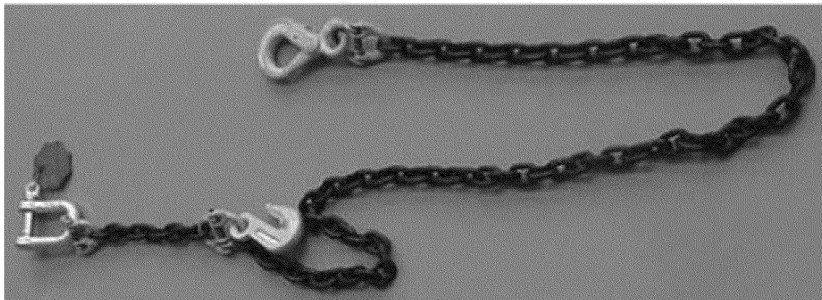

4

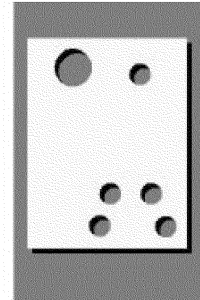

5

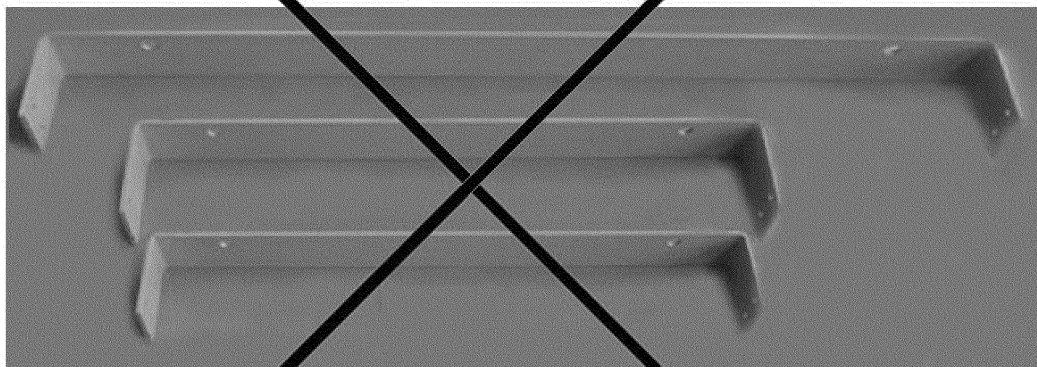

**FAA27EV  
FBA27EV**

REF. No.	PART No.	DESCRIPTION
1a	FAA81CF2	Axis
1b	FAA81CE1	Pin
2	FAA27ER2	Shackle $\varnothing$ 8 mm
3	FAA27ER1	Shackle $\varnothing$ 16 mm
4	FAA27FA1	Sling for CWT
5	<del>FAA27FH1</del> FBA27FH1	CWT Guide Lift

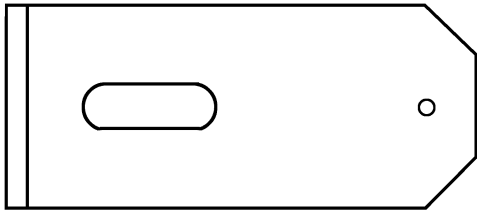
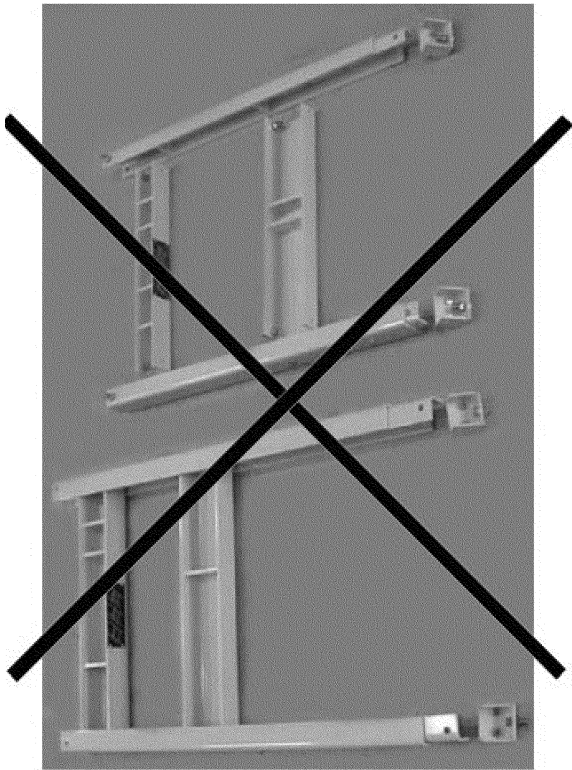

1

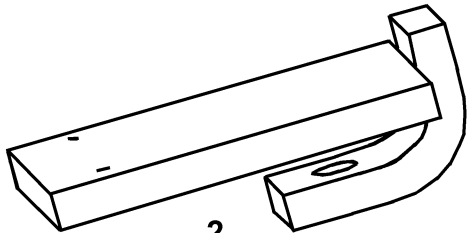

2

<b>FAA27EV FBA27EV</b>		
<b>REF. No.</b>	<b>PART No.</b>	<b>DESCRIPTION</b>
1	FAA27FX1	Plate for Plumb Line
2	<del>FAA27FY1</del> FBA27FY1	Tool for Plumb Line