

**Controller Part Main
Switch & Relay
Siemens (Sirius 3R)**

**Spare Parts Leaflet
10-GAA613GL-GN
July 2004 / Page 1 of 16**

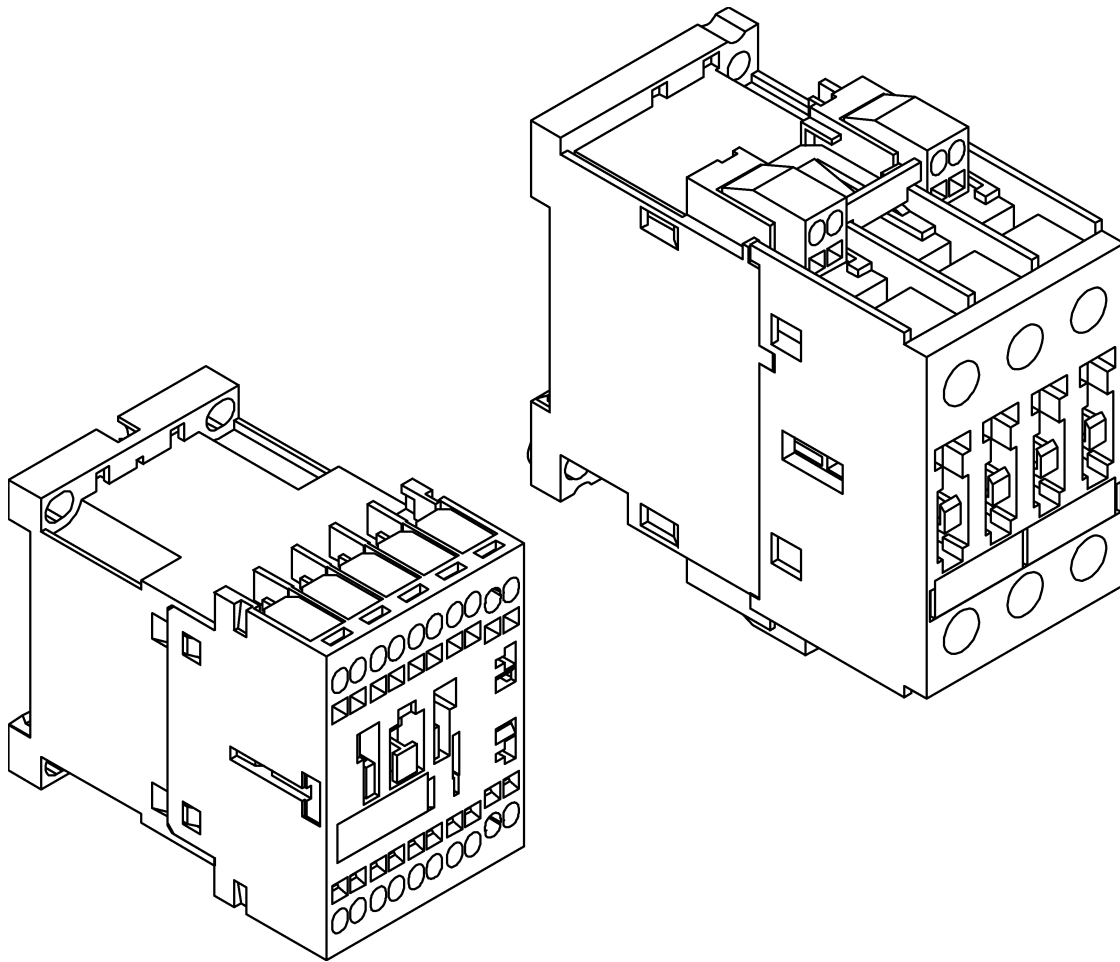

OTIS

Safety First!

**OEC BERLIN
Otis Elevator Company
Berlin, Germany**

Leaflet Description

The leaflet describes controller parts: main switches and relays from Siemens (Sirius 3R). The description includes :

- Type (3RT....)
- The rated coil voltage
- Number of contacts (NC, NO, MAIN)
- Rated power or current at 400 VAC
- RC-Network, diodes and over voltage suppressor

Leaflet Revisions

Date Revised	Subject Matter Expert	Reason for Revision
July 2004	Mustapha Toutaoui	Parts added: GAA661J1
---	---	---

Related Drawings

Drawing No.	Title	Drawing No.	Title
---	---	---	---
---	---	---	---

Related Documents

Document ID	Title
---	---
---	---

Subject Matter Expert

Name	Department
Mustapha Toutaoui	Engineering Center Berlin

About Spare Parts Leaflets...

This document lists the lowest replaceable units (LRUs) for the standard version of the product. The LRUs are chosen by a team of Otis associates representing engineering and manufacturing.

While goal of this document is to make parts identification as easy as possible, the document cannot be all-inclusive. Elevator and escalator contracts classified as "special" or "custom" are not addressed here. For such contracts, please refer to specified information, the contract folder, TIPs, Field Education Articles, Construction Letters, etc. for further information.

If you have any suggestions about this document, please contact the subject matter expert listed on this page.

Controller Part Main Switch & Relay Siemens (Sirius 3R)

10-GAA613GL-GN

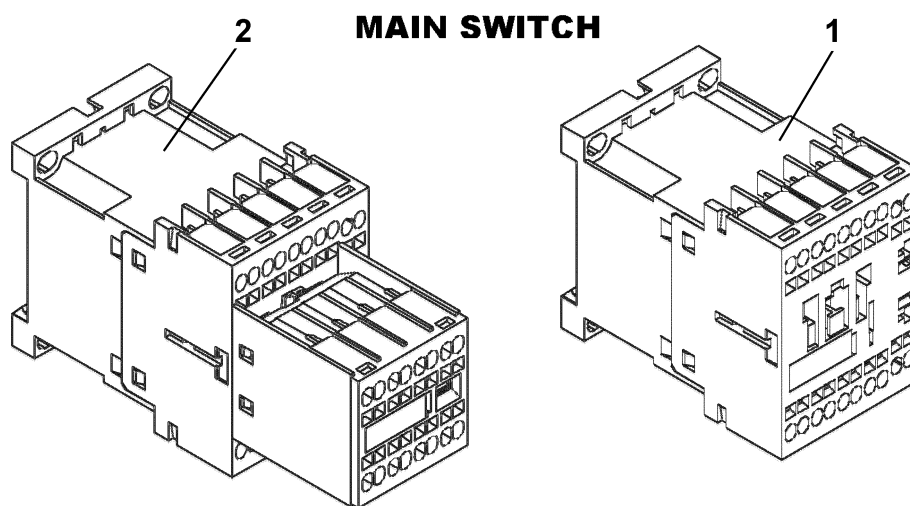

REF. No.	VINTAGE	DESCRIPTION						
		PART No.	TYPE	RATED COIL VOLTAGE	CONTACTS			RATED POWER AT 400 VAC
					NO	NC	MAIN	
1	GAA638DD1	3RT1017	110V; 50/60Hz	---	1	3	5.5 kW	
	GAA638DG1		30VDC ±30%	1	---		4.0 kW	
	GAA638CE1		110V; 50/60Hz	---	1		3.0 kW	
	GAA638DM1		48VDC					
	GAA638BH1		110V; 50/60Hz					
	GAA638EX1							
2	GAA638BD1	3RT1016	110V; 60Hz	2	2	3		4.0 kW
	GAA638BD2		48VDC					
	GAA638BJ1		30VDC					
	GAA638BK1		110V; 50/60Hz					
	GAA638BK2		110V; 60Hz					
	GAA638BP1		3RT1017				230V; 50/60Hz	5.5 kW
	GAA638BP2							
	GAA638BY1							

10-GAA613GL-GN

Controller Part Main Switch & Relay Siemens (Sirius 3R)

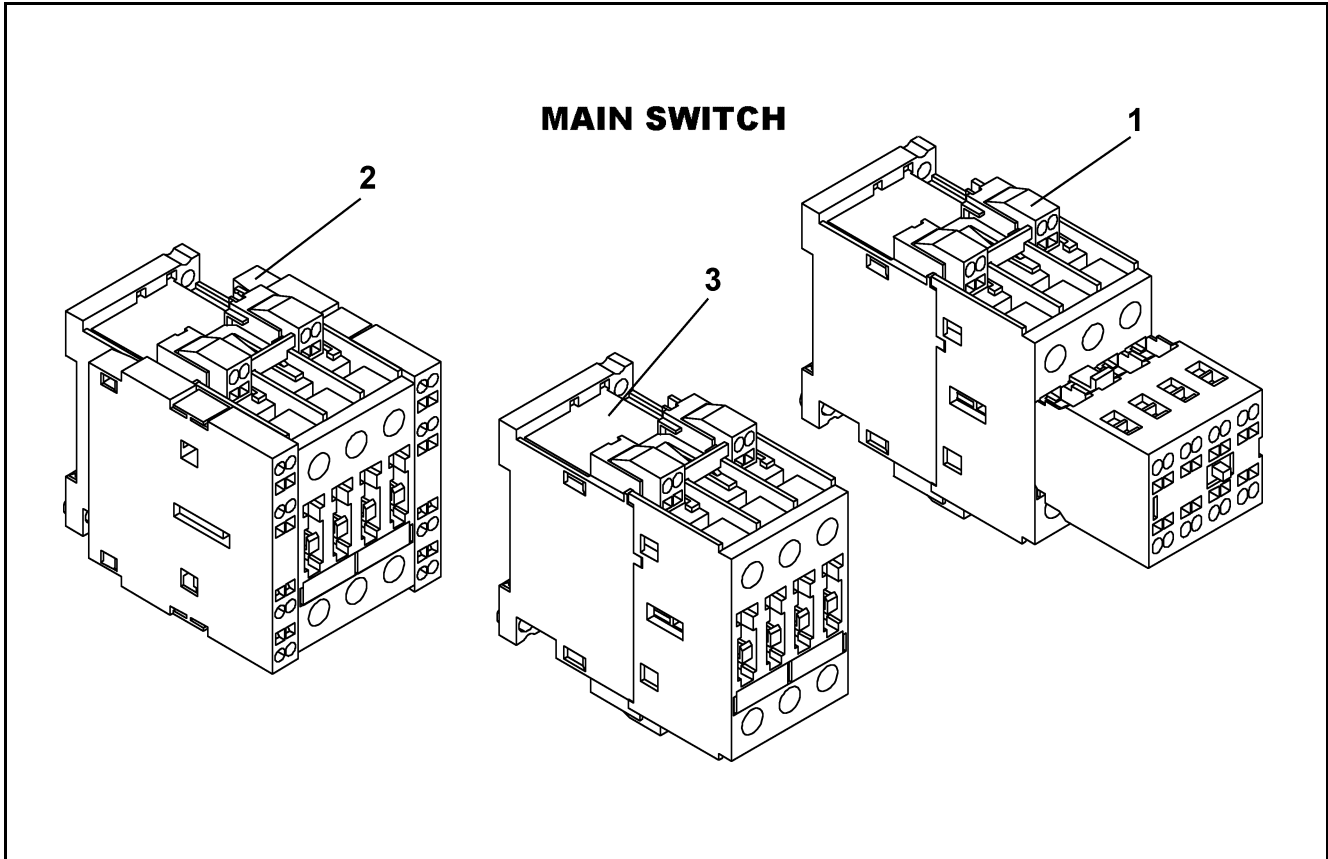

REF. No.	VINTAGE	PART No.	TYPE	RATED COIL VOLTAGE	DESCRIPTION			RATED POWER AT 400 VAC						
					CONTACTS									
					NO	NC	MAIN							
1	GAA638BE1	3RT1024		110V; 50Hz	2	2	3	5.5 kW						
	GAA638BE2			110V; 60Hz										
	GAA638BL1			48VDC										
	GAA638BM1	3RT1025		110V; 50Hz				2	2	3	7.5 kW			
	GAA638BM2			110V; 60Hz										
	GAA638CK1			48VDC										
	GAA638BN1	3RT1026		110V; 50Hz							2	2	3	11.0 kW
	GAA638BN2			110V; 60Hz										
	GAA638CL1			48VDC										

Controller Part Main Switch & Relay Siemens (Sirius 3R)

10-GAA613GL-GN

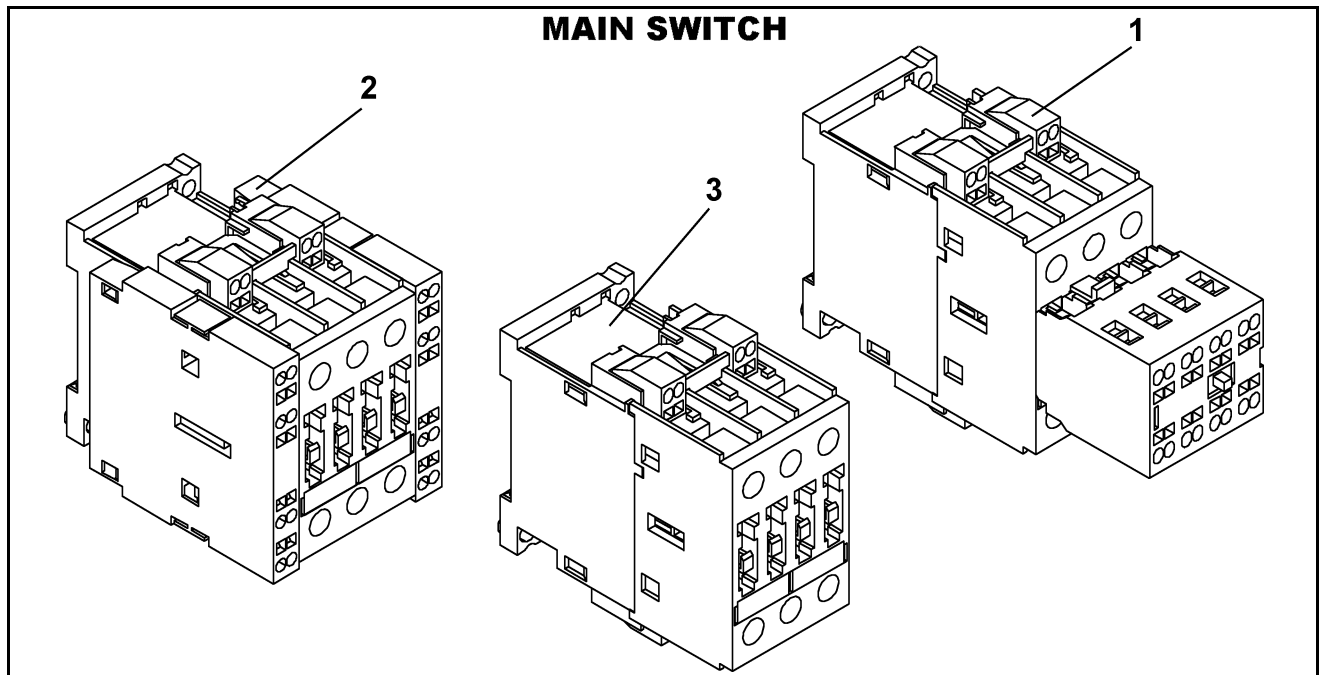

REF. No.	VINTAGE		DESCRIPTION				
	PART No.	TYPE	RATED COIL VOLTAGE	CONTACTS			RATED POWER AT 400 VAC
				NO	NC	MAIN	
2	GAA638DA1	3RT1024	110V; 50Hz	2	2	3	5.5 kW
	GAA638DA2		110V; 60Hz				
	GAA638BZ1	3RT1025	230V; 50Hz				7.5 kW
	GAA638BZ2		230V; 60Hz				
	GAA638BZ3		230V; 50/60Hz				
	GAA638BZ4		110V; 50Hz				
	GAA638BZ5		110V; 60Hz				
	GAA638CA1	3RT1026	230V; 50Hz				11.0 kW
	GAA638CA2		230V; 60Hz				
	GAA638CA3		230V; 50/60Hz				
	GAA638CA4		110V; 50Hz				
	GAA638CA5		110V; 60Hz				
3	GAA638DT1	3RT1024	110V; 50/60Hz				5.5 kW
	GAA638DV1	3RT1035					7.5 kW
	GAA638DW1	3RT1026					11.0 kW

10-GAA613GL-GN

Controller Part Main Switch & Relay Siemens (Sirius 3R)

MAIN SWITCH

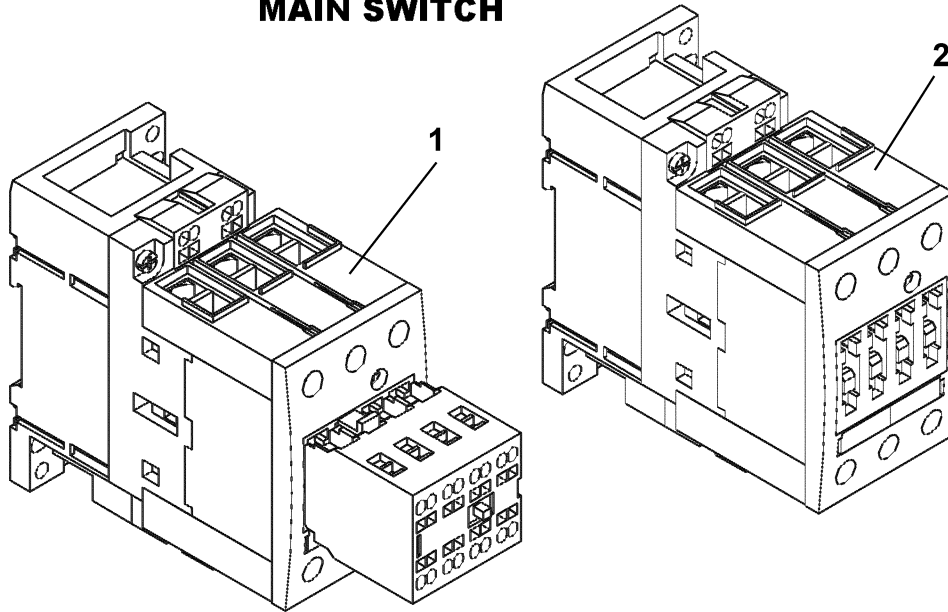

REF. No.	PART No.	TYPE	RATED COIL VOLTAGE	CONTACTS			RATED POWER AT 400 VAC						
				NO	NC	MAIN							
				DESCRIPTION									
1	GAA638BF1	3RT1034	110V; 50Hz	2	2	3	15.0 kW						
	GAA638BF2		110V; 60Hz										
	GAA638CM1		48VDC										
	GAA638CN1	3RT1035	110V; 50Hz				2	2	3	18.5 kW			
	GAA638CN2		110V; 60Hz										
	GAA638CP1		48VDC										
	GAA638CR1	3RT1036	110V; 50Hz							2	2	3	22.0 kW
	GAA638CR2		110V; 60Hz										
	GAA638CS1		48VDC										
2	GAA638DC1	3RT1034	230V; 50Hz	---	---								15.0 kW
	GAA638DC2		230V; 60Hz										
	GAA638DX1	3RT1035	110V; 50/60Hz										---
	GAA638DY1						3RT1036	22.0 kW					

Controller Part Main Switch & Relay Siemens (Sirius 3R)

10-GAA613GL-GN

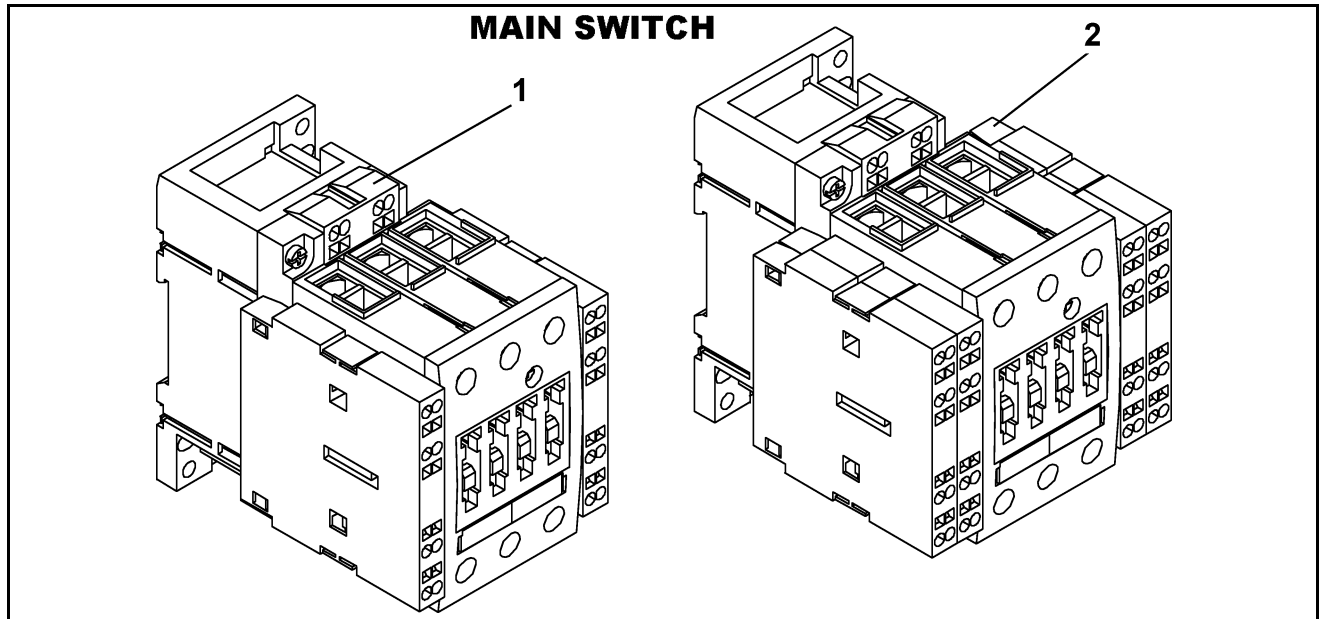

REF. No.	VINTAGE		DESCRIPTION					
	PART No.	TYPE	RATED COIL VOLTAGE	CONTACTS			RATED POWER AT 400 VAC	
				NO	NC	MAIN		
1	GAA638CB1	3RT1034	230V; 50Hz	2	2	3	15.0 kW	
	GAA638CB2		230V; 60Hz					
	GAA638CB3		230V; 50/60Hz					
	GAA638CB4		110V; 50Hz					
	GAA638CB5		110V; 60Hz					
	GAA638CC1	3RT1035	230V; 50Hz				18.5 kW	
	GAA638CC2		230V; 60Hz					
	GAA638CC3		230V; 50/60Hz					
	GAA638DL1		110V; 50Hz					
	GAA638DL2		110V; 60Hz					
	GAA638CD1	3RT1036	230V; 50Hz					22.0 kW
	GAA638CD2		230V; 60Hz					
	GAA638CD3		230V; 50/60Hz					
	GAA638CD4		110V; 50Hz					
	GAA638CD5		110V; 60Hz					

10-GAA613GL-GN

**Controller Part Main Switch
& Relay Siemens (Sirius 3R)**

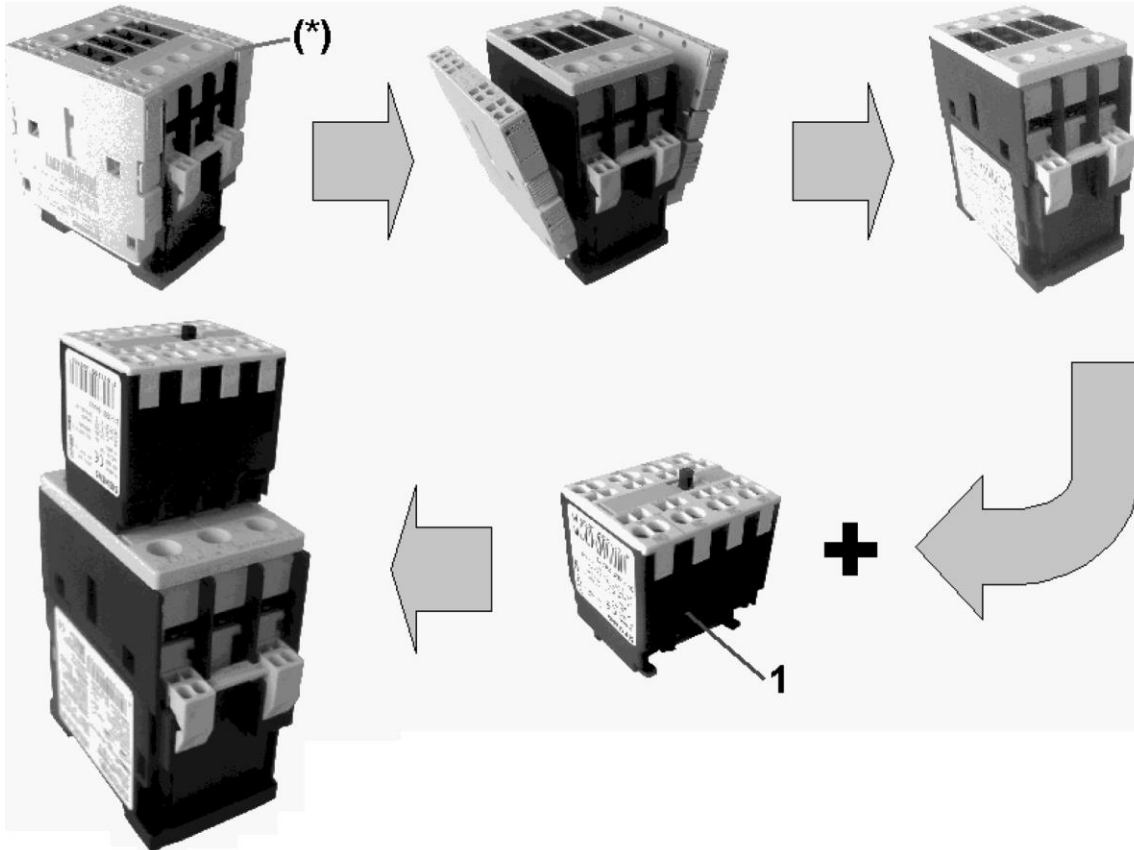

REF. No.	VINTAGE	DESCRIPTION				
	PART No.	TYPE	CONTACTS			
			NO	NC	MAIN	
1	GAA661J1	3RH1921	2	2	---	
			(*) Main contactors available in MCS220 (M) with OVF20			
			GAA638B1	GAA638BM2	GAA638BN1	GAA638BN2
			GAA638CN1	GAA638CN2	GAA638BE1	GAA638BE2

Controller Part Main Switch & Relay Siemens (Sirius 3R)

10-GAA613GL-GN

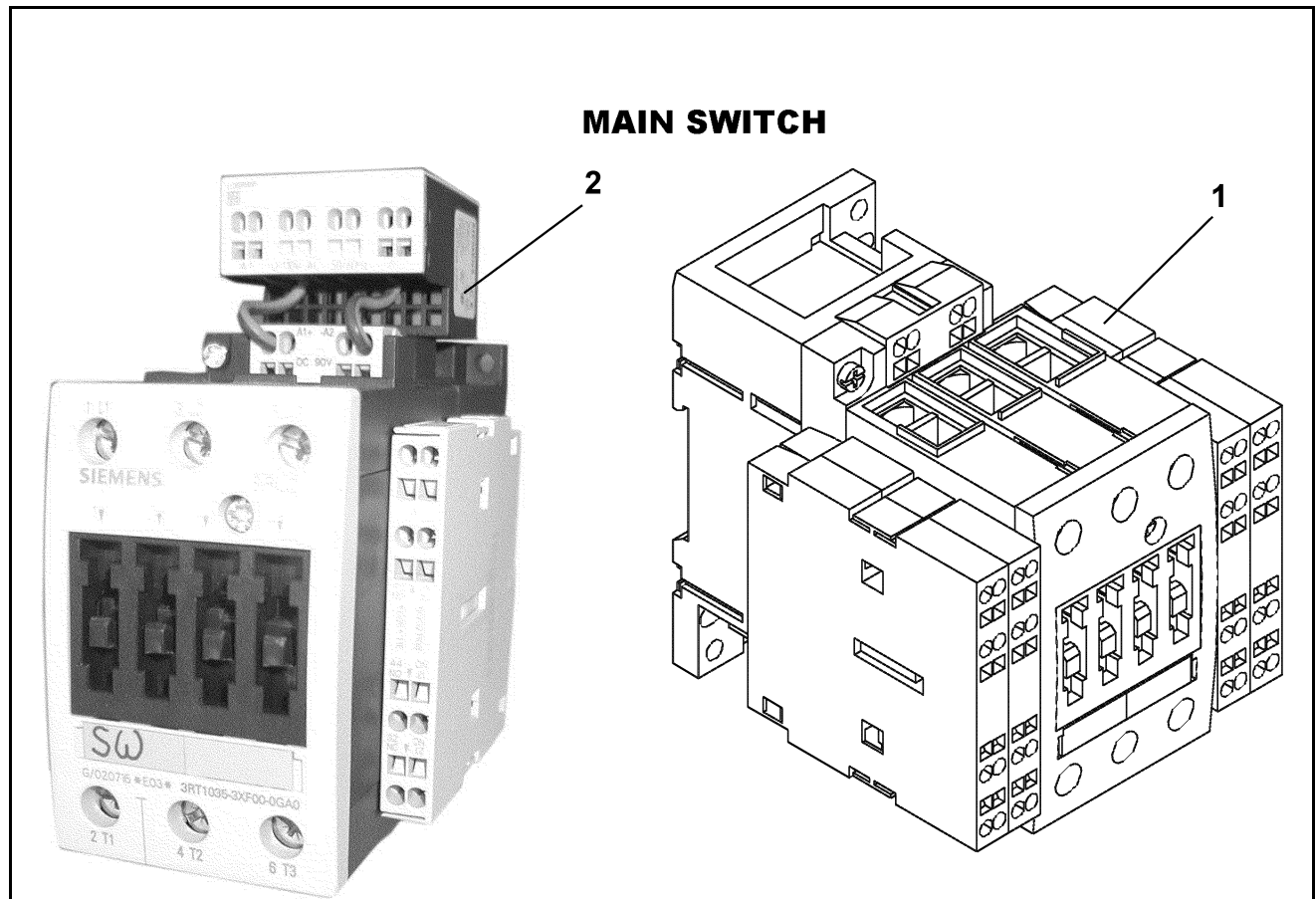

⊙) = 2 NORMAL CONTACTS + 1 CONTACT USED FOR ELECTRONIC CONTROL

REF. No.	VINTAGE	PART No.	TYPE	RATED COIL VOLTAGE	DESCRIPTION			RATED POWER AT 400 VAC
					CONTACTS			
					NO	NC	MAIN	
1		GAA638EB1	3RT1034	110V; 50Hz	3⊙)	3⊙)	3	15.0 kW
		GAA638EB2		110V; 60Hz				
		GAA638EA1	3RT1035	110V; 50Hz	2	2	3	18.5 kW
		GAA638EA2		110V; 60Hz				
		GAA638EW1		110V; 60Hz				

10-GAA613GL-GN

Controller Part Main Switch & Relay Siemens (Sirius 3R)

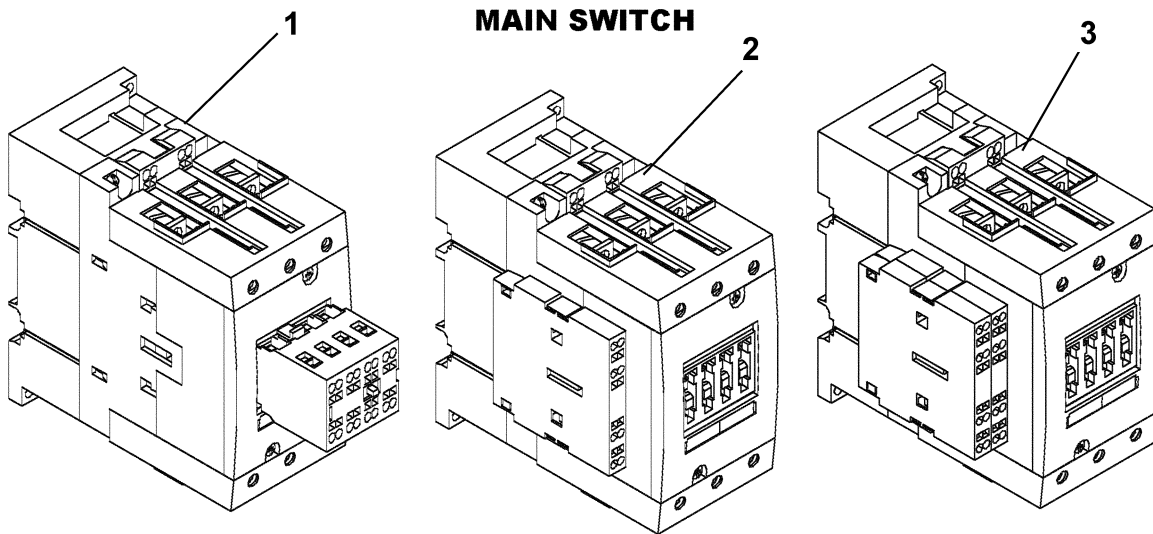

REF. No.	VINTAGE	PART No.	TYPE	RATED COIL VOLTAGE	DESCRIPTION			RATED POWER AT 400 VAC			
					CONTACTS						
					NO	NC	MAIN				
1	GAA638CT1	3RT1044		110V; 50Hz	2	2	3	30.0 kW			
	GAA638CT2			110V; 60Hz							
	GAA638CV1			48VDC							
	GAA638CW1	3RT1045		110V; 50Hz				2	2	3	37.0 kW
	GAA638CW2			110V; 60Hz							
	GAA638CX1			48VDC							
	GAA638CY1	3RT1046		110V; 50Hz							2
GAA638CY2	110V; 60Hz										
GAA638CZ1	48VDC										
2	GAA638DN1	3RT1044		230V; 50Hz	2	2	3				
	GAA638DN2			230V; 60Hz							
	GAA638DN3			230V; 50/60Hz							
	GAA638DN4			110V; 50Hz							
	GAA638DN5			110V; 60Hz							

Controller Part Main Switch & Relay Siemens (Sirius 3R)

10-GAA613GL-GN

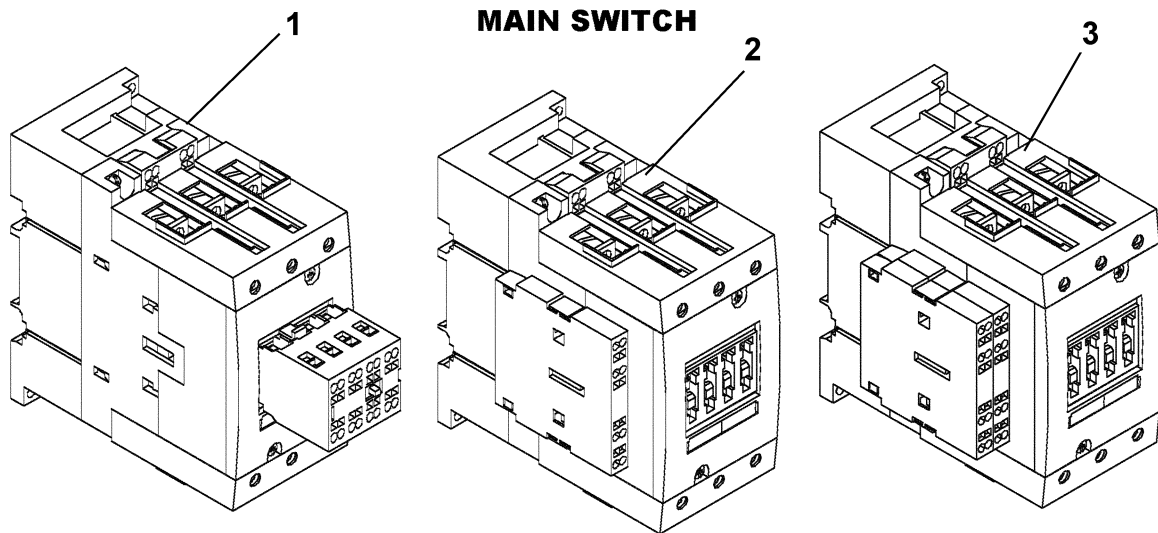

②) = 2 NORMAL CONTACTS + 1 CONTACT USED FOR ELECTRONIC CONTROL

REF. No.	VINTAGE PART No.	TYPE	RATED COIL VOLTAGE	DESCRIPTION			RATED POWER AT 400 VAC
				CONTACTS			
				NO	NC	MAIN	
2	GAA638DP1	3RT1045	230V; 50Hz	2	2	3	37.0 kW
	GAA638DP2		230V; 60Hz				
	GAA638DP3		230V; 50/60Hz				
	GAA638DP4		110V; 50Hz				
	GAA638DP5		110V; 60Hz				
	GAA638DR1	3RT1046	230V; 50Hz				
	GAA638DR2		230V; 60Hz				
	GAA638DR3		230V; 50/60Hz				
	GAA638DR4		110V; 50Hz				
	GAA638DR5		110V; 60Hz				
3	GAA638DZ1	3RT1045	110V; 50Hz	②)	②)	37.0 kW	
	GAA638DZ2		110V; 60Hz				

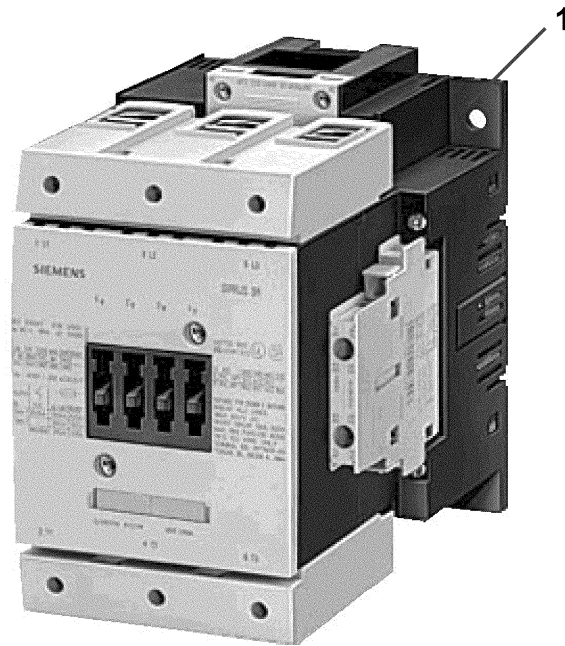
10-GAA613GL-GN**Controller Part Main Switch
& Relay Siemens (Sirius 3R)**

REF. No.	VINTAGE	DESCRIPTION					
	PART No.	TYPE	RATED COIL VOLTAGE	CONTACTS			RATED POWER AT 400 VAC
				NO	NC	MAIN	
1	GAA638EG1	3RT1054	220-240V; 40-60Hz &DC	2	2	3	55 kW
	GAA638EH	3RT1055					75 kW
	GAA638EJ1	3RT1056					90 kW
	GAA638FB1	3RT1316	110VAC	---	---	4	3 kW
	GAA638FB2		48VDC				

Controller Part Main Switch & Relay Siemens (Sirius 3R)

10-GAA613GL-GN

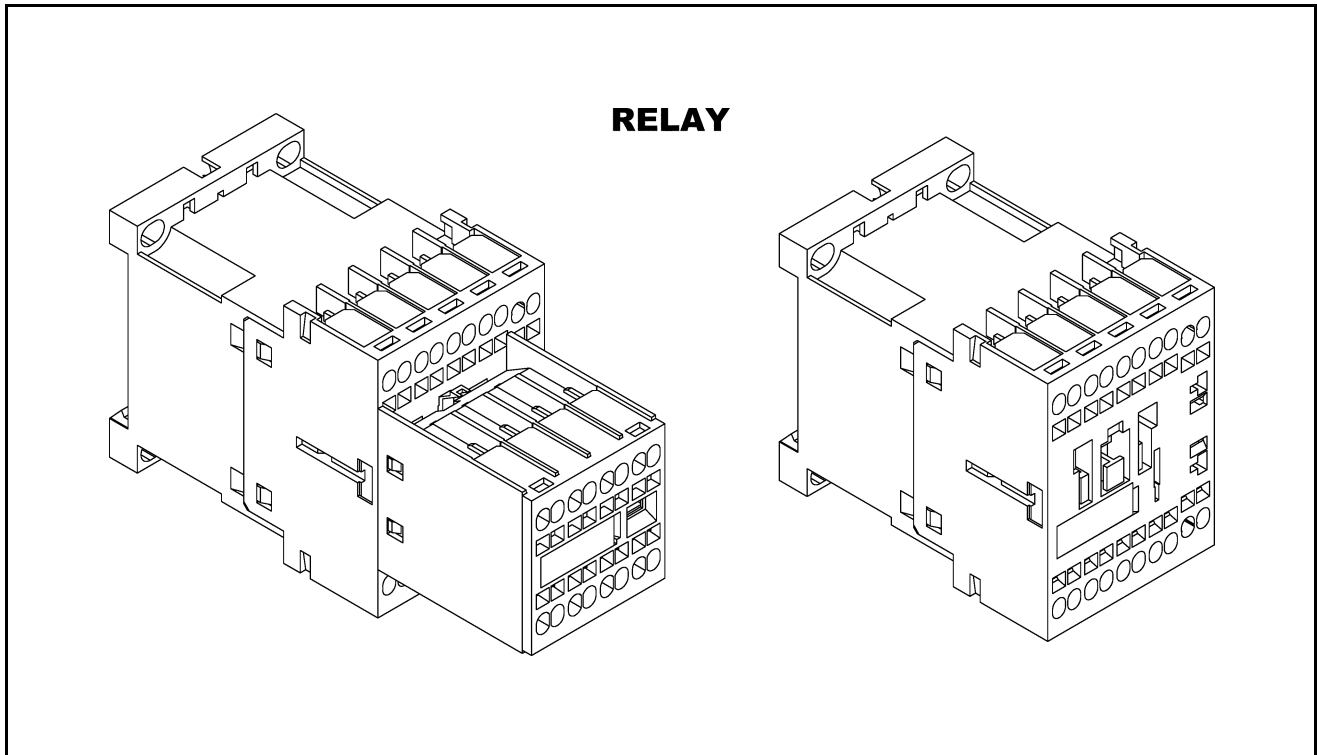

REF. No.	VINTAGE		DESCRIPTION			
	PART No.	TYPE	RATED COIL VOLTAGE	CONTACTS		RATED POWER AT 400 VAC
				NO	NC	
1	GAA638HS1	3RH1380	110V; 50/60Hz	8	---	3.0 A
	GAA638GL3	3RH1362		6	2	
	GAA638GL4	3RH1344		4	4	
	GAA638GY1		220V; 50/60Hz			
	GAA638GZ3		30VDC			
	GAA638GZ1		48VDC			
	GAA638GZ2		24VDC	6	2	
	GAA638HD2	3RH1362	48VDC			
	GAA638HD1		30VDC			
	GAA638HC1		110V; 60Hz			
	GAA638GY2	3RH1344		4	4	

**Controller Part Main Switch
& Relay Siemens (Sirius 3R)**

RELAY

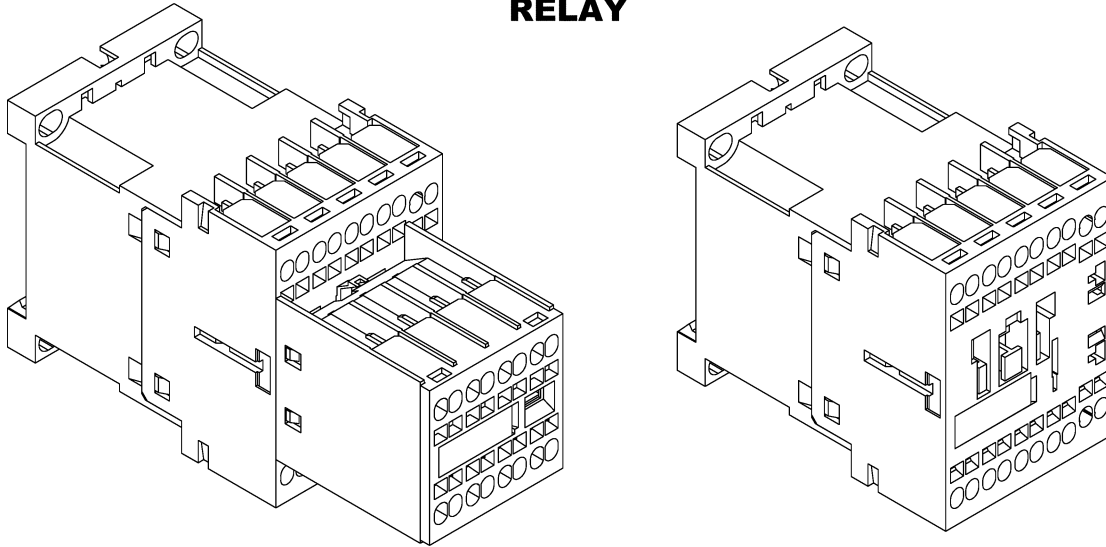

⊕) = WITH RECTIFIER

REF. No.	PART No.	VINTAGE	TYPE	DESCRIPTION		RATED POWER AT 400 VAC	
				RATED COIL VOLTAGE	CONTACTS		
					NO		NC
2	GAA638GM1		3RH1140	110V; 50/60Hz	4	---	3.0 A
	GAA638GM2		3RH1122		2	2	
	GAA638GT1		3RH1131	110V; 60Hz	3	1	
	GAA638GT2						
	GAA638GN1						
	GAA638GV1		110VDC				
	GAA638GR1		3RH1122	230V; 50/60Hz	2	2	
	GAA638GR2		110V; 60Hz				
	GAA638GS2		24VDC				
	GAA638GS1		48VDC				
	GAA638GN2		3RH1140		4	---	
	GAA638HR1		3RH1122	110V; 50/60Hz	2	2	
	GAA638HR2		3RH1131		3	1	
	GAA638HR3		3RH1140		4	---	

Controller Part Main Switch & Relay Siemens (Sirius 3R)

10-GAA613GL-GN

RELAY WITH MECH. LATCHING

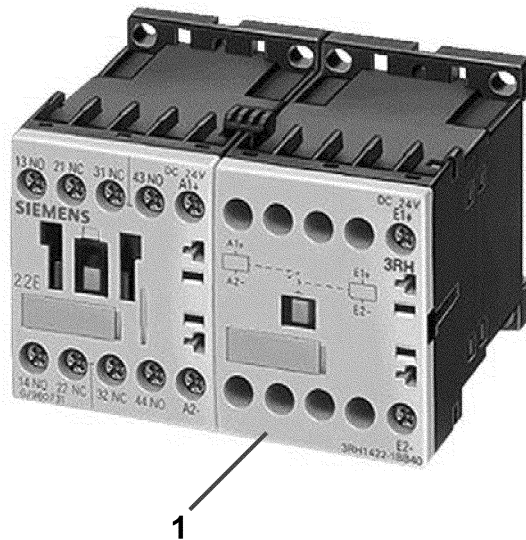

INTERFACE RELAY

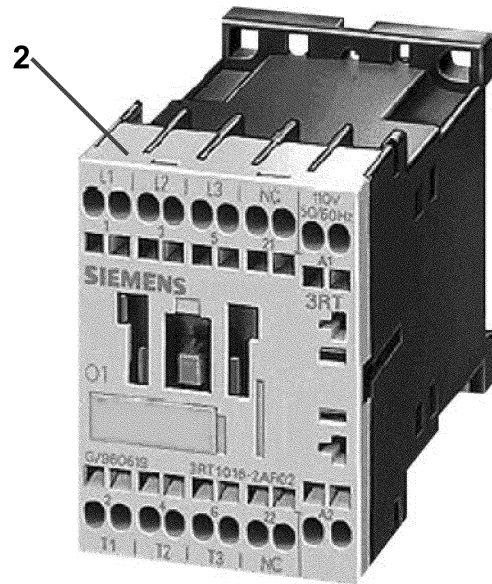

REF. No.	VINTAGE	PART No.	TYPE	RATED COIL VOLTAGE	DESCRIPTION		RATED POWER AT 400 VAC
					CONTACTS		
					NO	NC	
1		GAA613HF1	3RH1453	230V; 50/60Hz	5	3	3.0 A
2		GAA613HN1	3RH1122	24VDC; 1.4W W Diode	2	2	
		GAA613HN2					
		GAA613HE4	3RH1131	24VDC; 2.3W	3	1	
		GAA613HE1	3RH1122	30VDC±30%	2	2	
		GAA613HE2	3RH1131		3	1	
		GAA613HE3	3RH1140		4	---	

**Controller Part Main Switch
& Relay Siemens (Sirius 3R)**

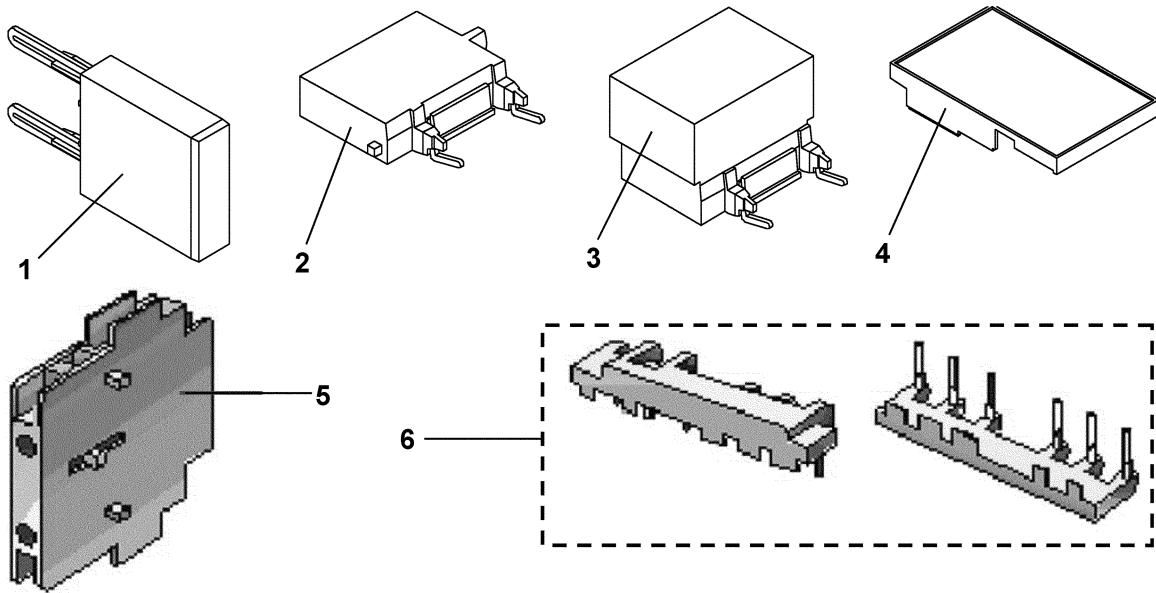

REF. No.	PART No.	RATED COIL VOLTAGE	DESCRIPTION
1	GAA605H12	48-127VAC	RC-Network
2	GAA605H13	70-150VDC	
3	GAA605H14		
1	GAA605H18	127-240VAC	Diode (interference suppressor)
2	GAA605H19	150-250VDC	
3	GAA605H20		
1	GAA605H15	12-250VDC	Diode & Z-diode Combination (short fall delay time)
	GAA605H16		
2	GAA605H17	30-250VDC	
1	GAA605H22	180-255VAC	Over Voltage Suppressor
4	GAA329AL1	Dust Cap	
5	GAA638EP3	Interlock	
6	GAA638EP1	Used for 3RT102...Set of Bridges	
	GAA638EP2	Used for 3RT103...Set of Bridges	