

**Fixture: Jewel  
Assembly**

**Spare Parts Leaflet**

**31-AAA23851B**

**February 19, 2020 / Page 1 of 8**

**W/O VINTAGE**

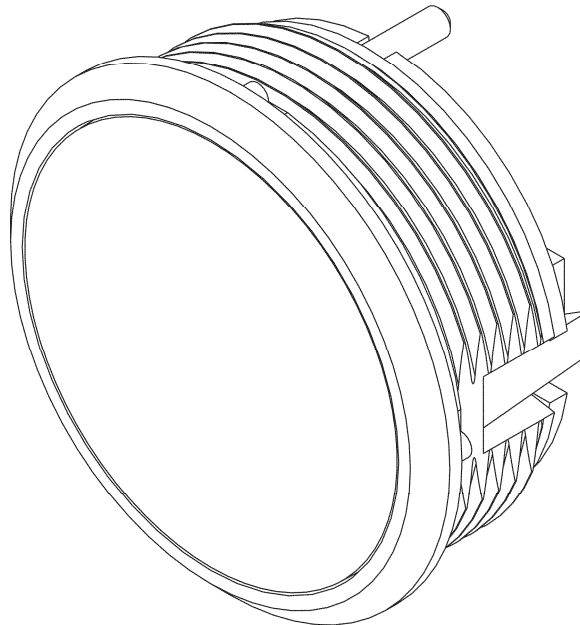

**OTIS**

This document does not contain any  
technical data subject to EAR or ITAR

**SERVICE ENGINEERING**

**Otis Elevator Company**

**Bloomfield, Connecticut USA**

Unpublished Work—© Otis Elevator Co.; 2020

**Leaflet Description**

This leaflet details the replacement parts used in AAA23851B assembly. In addition, it contains information for the PCBs that are required to make the jewel light up. The circuit board and the nut must be ordered separately.

**Leaflet Revisions**

<b>Date Revised</b>	<b>Subject Matter Expert</b>	<b>Reason for Revision</b>
October 25, 2003	Dennis Rehmer	New SPL
July 12, 2006	Joseph D. Zych	Added PCB p/ns AAA26800AJS4 and AAA26800AJS6 and Nut p/n AAA72JZ1
May 25, 2011	Joseph D. Zych	Add new parts AAA23851B35, 36
February 19, 2020	Ramone Reynolds	Added AAA23851B37 on new p. 8

**Related Drawings**

<b>Drawing No.</b>	<b>Title</b>	<b>Drawing No.</b>	<b>Title</b>
AAA23851B	Hall Option Assembly, Landing Fixture Jewel	---	---
---	---	---	---

**Related Documents**

<b>Document ID</b>	<b>Title</b>
32-AAA23500AN	Series 2 Hall Panel w/ & w/o Flashing Sign

**Subject Matter Expert**

<b>Name</b>	<b>Department</b>
Ramone Reynolds	OSC Service Engineering

**About Spare Parts Leaflets...**

This document lists the lowest replaceable units (LRUs) for the standard version of the product. The LRUs are chosen by a team of Otis associates representing engineering and manufacturing.





While goal of this document is to make parts identification as easy as possible, the document cannot be all-inclusive. Elevator and escalator contracts classified as "special" or "custom" are not addressed here. For such contracts, please refer to specified information, the contract folder, TIPs, Field Education Articles, Construction Letters, etc. for further information.

If you have any suggestions about this document, please contact the subject matter expert listed on this page.

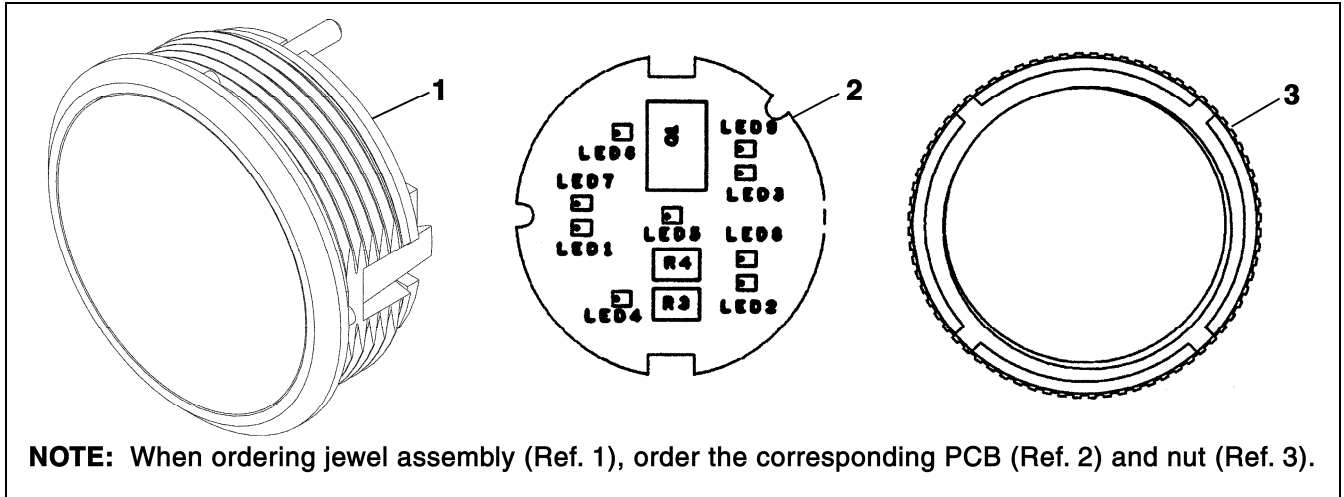
# Jewel Assembly

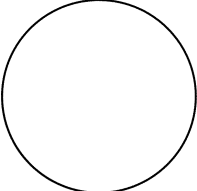
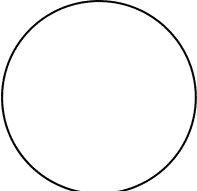
**31-AAA23851B**



REF. 1			REF. 2	REF. 3
JEWEL	DESCRIPTION	MARKING	PCB	NUT
AAA23851B7	Red, Jewel Marking: Blank		AAA26800AJS4	AAA72JZ1
AAA23851B9	Blue, Jewel Marking: Blank		AAA26800AJS6	
AAA23851B13	Red, Jewel Marking: Restricted Floor (English)		AAA26800AJS4	
AAA23851B14	Blue, Jewel Marking: Medical Emergency		AAA26800AJS6	
AAA23851B16	Red, Jewel Marking: Priority Service (English)		AAA26800AJS4	

(Continued on next page)

# 31-AAA23851B

# Jewel Assembly

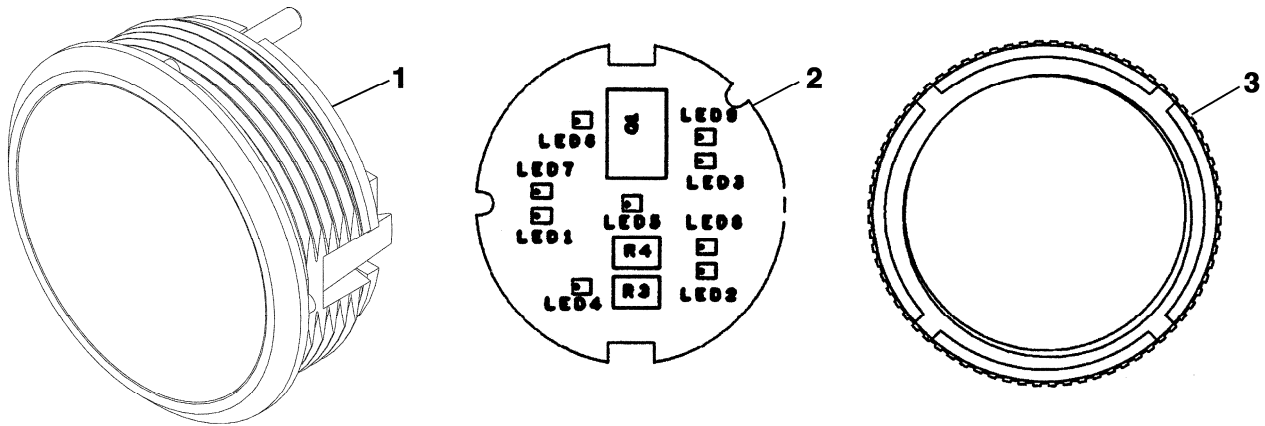

**NOTE:** When ordering jewel assembly (Ref. 1), order the corresponding PCB (Ref. 2) and nut (Ref. 3).

REF. 1			REF. 2	REF. 3
JEWEL	DESCRIPTION	MARKING	PCB	NUT
AAA23851B18	Red, Jewel Marking: Group Security (English)		AAA26800AJS4	AAA72JZ1
AAA23851B19	Red, Jewel Marking: Car to Lobby (English)			
AAA23851B20	Red, Jewel Marking: Power (English)			
AAA23851B21	Red, Jewel Marking: Hat Symbol (English)			
AAA23851B22	Red, Jewel Marking: Emergency Recall (English)			

(Continued on next page)

# Jewel Assembly

**31-AAA23851B**

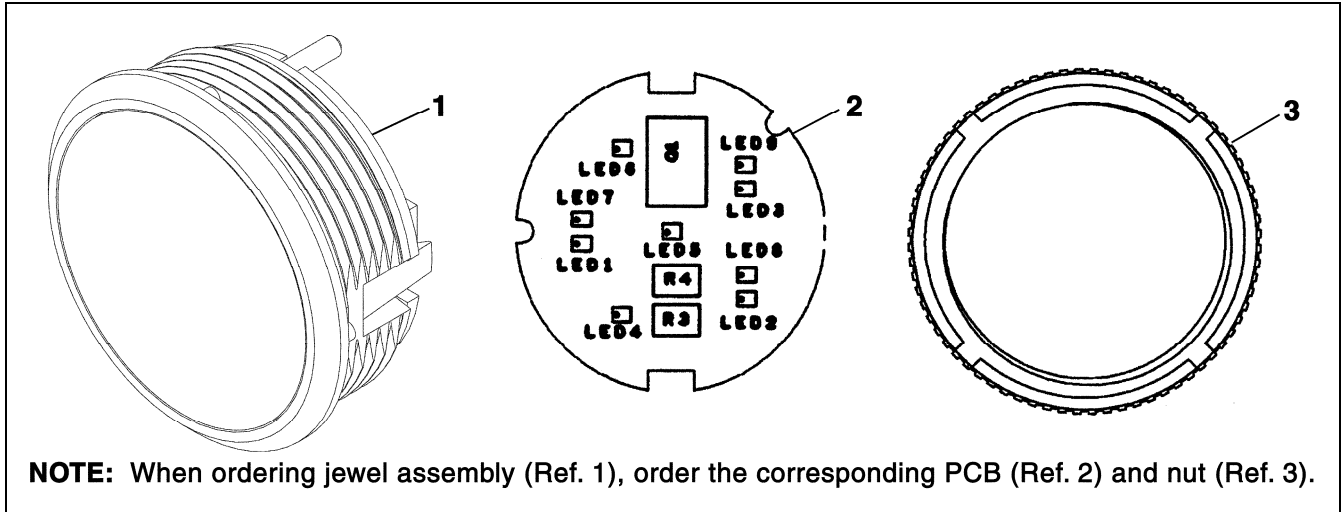

**NOTE:** When ordering jewel assembly (Ref. 1), order the corresponding PCB (Ref. 2) and nut (Ref. 3).

REF. 1			REF. 2	REF. 3
JEWEL	DESCRIPTION	MARKING	PCB	NUT
AAA23851B23	Red, Jewel Marking: Elevator Emergency Power (English)		AAA26800AJS4	AAA72JZ1
AAA23851B24	Red, Jewel Marking: Auto (English)			
AAA23851B25	Red, Jewel Marking: Manual (English)			
AAA23851B26	Red, Jewel Marking: Further Demand (English)			
AAA23851B27	Red, Jewel Marking: PALIER À ACCÈS LIMITÉ (French)			

(Continued on next page)

# 31-AAA23851B

# Jewel Assembly

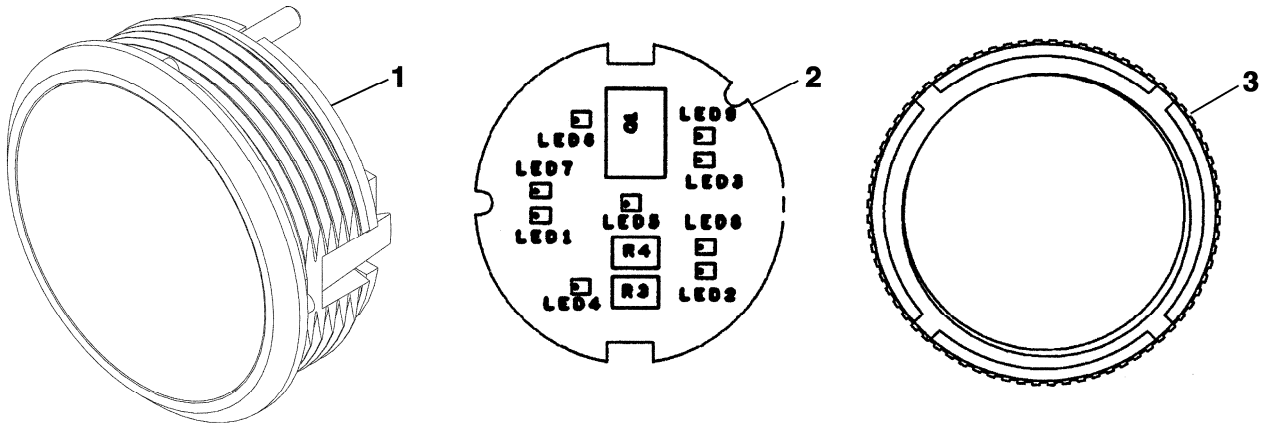

**NOTE:** When ordering jewel assembly (Ref. 1), order the corresponding PCB (Ref. 2) and nut (Ref. 3).

REF. 1			REF. 2	REF. 3
JEWEL	DESCRIPTION	MARKING	PCB	NUT
AAA23851B28	Red, Jewel Marking: Express Priority (French)	SERV. PRIORITAIRE	AAA26800AJS4	AAA72JZ1
AAA23851B29	Red, Jewel Marking: Group Security (French)	SÉCURITÉ DE GROUPE		
AAA23851B30	Red, Jewel Marking: Car to Lobby (French)	CABINE AU HALL		
AAA23851B31	Red, Jewel Marking: Please Exit (French)	PRIÈRE DE SORTIR AU PROCHAIN ARRÊT		

(Continued on next page)

# Jewel Assembly

**31-AAA23851B**

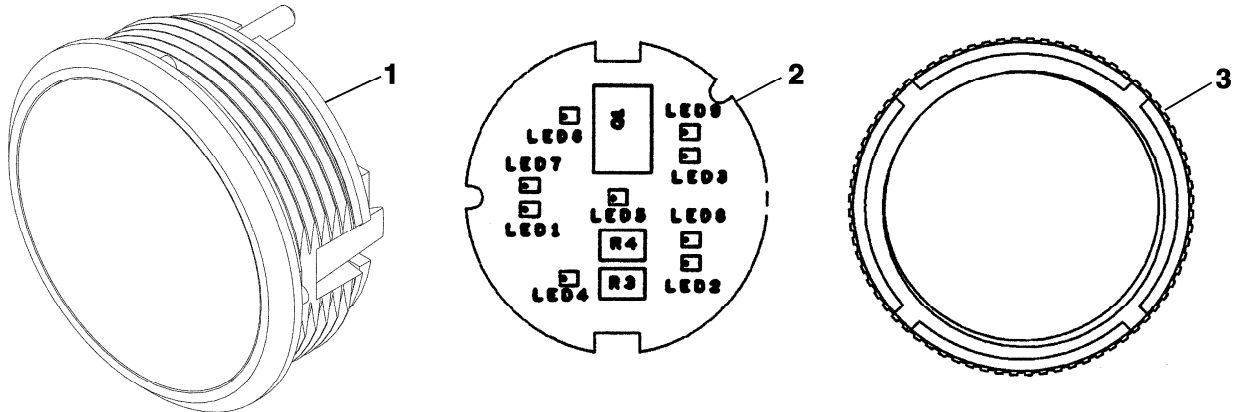

**NOTE:** When ordering jewel assembly (Ref. 1), order the corresponding PCB (Ref. 2) and nut (Ref. 3).

REF. 1			REF. 2	REF. 3
JEWEL	DESCRIPTION	MARKING	PCB	NUT
AAA23851B32	Red, Jewel Marking: SES Phase I (French)		AAA26800AJS4	AAA72JZ1
AAA23851B33	Red, Jewel Marking: Standby Power (French)			
AAA23851B34	Red, Jewel Marking: Please Exit (English)			
AAA23851B35	Red, Jewel Marking: Elevator Communications Failure (English)			
AAA23851B36	Red, Jewel Marking: Elevator Communications Failure (French)			

# 31-AAA23851B

# Jewel Assembly

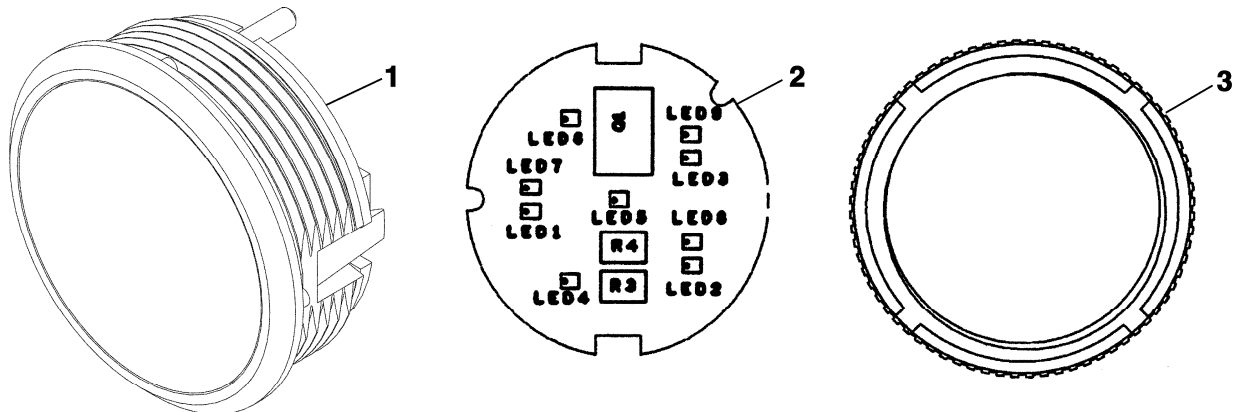

**NOTE:** When ordering jewel assembly (Ref. 1), order the corresponding PCB (Ref. 2) and nut (Ref. 3).

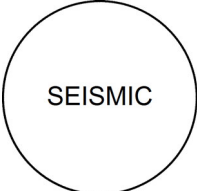
REF. 1			REF. 2	REF. 3
JEWEL	DESCRIPTION	MARKING	PCB	NUT
AAA23851B37	Red, Jewel Marking: Seismic (English)		AAA26800AJS4	AAA72JZ1