

**Metal Graphic Inserts:
AAA250G, AAA250K,
AAA250M**

Spare Parts Leaflet

31-AAA250G

July 22, 2020 / Page 1 of 10

W/O VINTAGE

* All Markings Are White Unless Otherwise Noted
All Braille Is English Unless Otherwise Noted

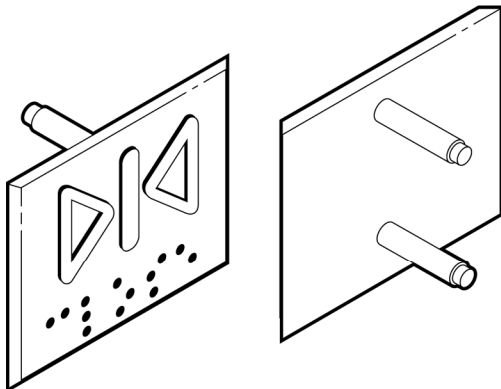

TYPE AAA250G2, G4

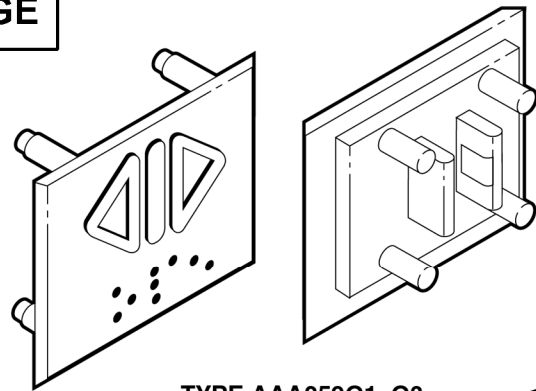

TYPE AAA250G1, G3

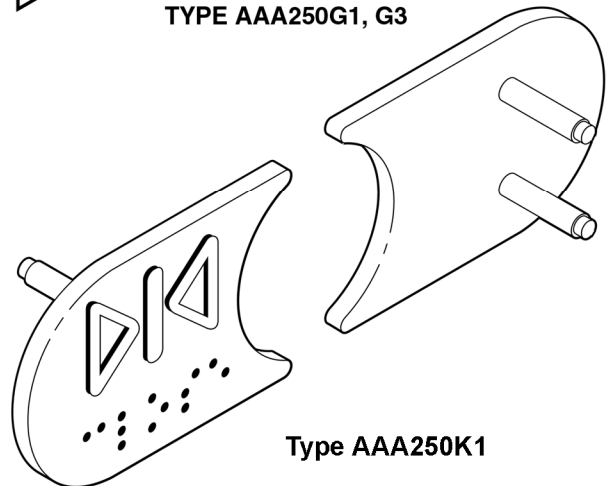

Type AAA250K1

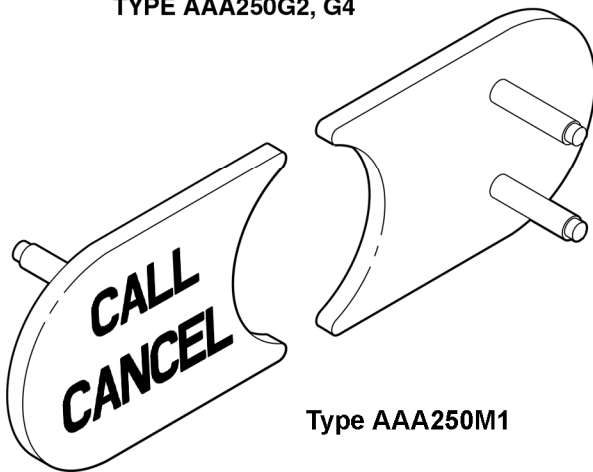

Type AAA250M1

OTIS

This document does not contain any
technical data subject to EAR or ITAR

SERVICE ENGINEERING
Otis Elevator Company
Bloomfield, Connecticut USA

Unpublished Work—© Otis Elevator Co.; 2020

Leaflet Description

This leaflet provides spare parts information for AAA250G and AAA250K graphic inserts. For standardization purposes, color changes were made in 1998 to offer both charcoal gray/black and black type AAA250G inserts. AAA250G3 and AAA250G4 were created to cover all applications where black inserts are required. AAA250G1 and AAA250G2 cover the charcoal gray/black applications.

Leaflet Revisions

Date Revised	Subject Matter Expert	Reason for Revision
November 1, 1999	Stephen Karvazy	New SPL
January 1, 2001	Stephen Karvazy	Include AAA250K1 graphic inserts
October 10, 2009	Joseph Zych	Added text "metal" to the graphic inserts description; added AAA205M1 graphic inserts.
September 11, 2013	Joseph Zych	Corrected p/n AAA250K1-ISTAR1 on p. 9
January 10, 2018	Ramone Reynolds	Added AAA250K1-IPHONE2 and -IPHONE3 on p. 9
July 22, 2020	Joseph Zych	Updated document title

Related Drawings

Drawing No.	Title	Drawing No.	Title
AAA250G	Graphic Insert	AAA26XK	Detail: Paint Specifications
AAA250K	Graphic Insert	AAA26YW	Braille Dot Configurations (Grade II)
AAA250M	Graphic Insert		

Related Documents

Document ID	Title
SPL 31-250D	Advanced Fixtures: Graphic Inserts
---	---

Subject Matter Expert

Name	Department
Ramone Reynolds	OSC Service Engineering

About Spare Parts Leaflets...

This document lists the lowest replaceable units (LRUs) for the standard version of the product. The LRUs are chosen by a team of Otis associates representing engineering and manufacturing.

While goal of this document is to make parts identification as easy as possible, the document cannot be all-inclusive. Elevator and escalator contracts classified as "special" or "custom" are not addressed here. For such contracts, please refer to specified information, the contract folder, TIPs, Field Education Articles, Construction Letters, etc. for further information.

If you have any suggestions about this document, please contact the subject matter expert listed on this page.

AAA250G Metal Graphic Insert Assemblies

31-AAA250G

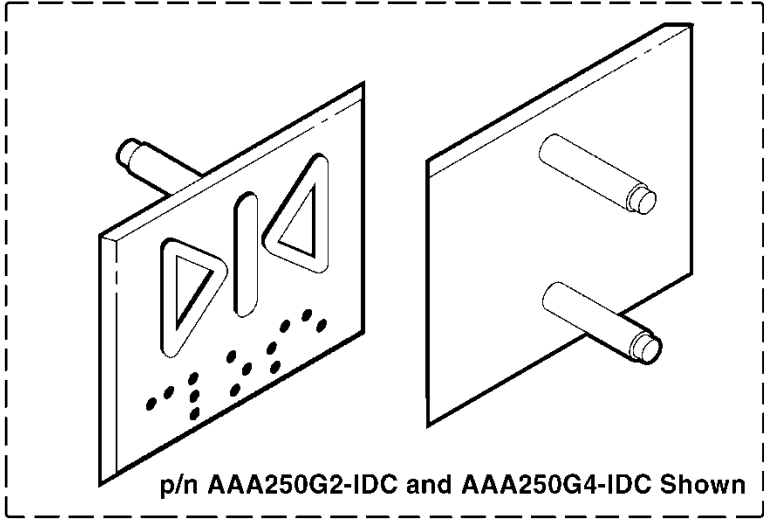
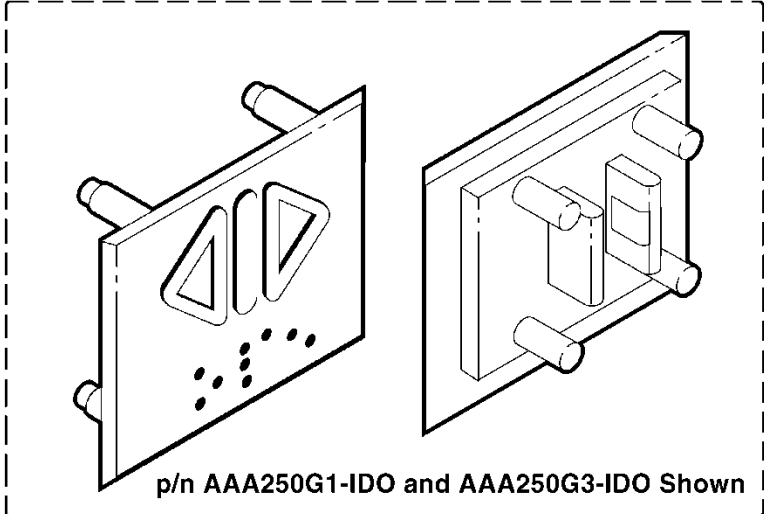

W/O VINTAGE			
REF. No.	PART No.	DESCRIPTION	COLOR
1	AAA250G1	Insert, Metal Graphic, Two 72CE20 Clips for Each Assembly (pre-assembled)	Charcoal Gray
	AAA250G3		Black
2	AAA250G2	Insert, Metal Graphic, Two AAA72HD1 Self-Threading Nuts for Each Assembly (unassembled)	Charcoal Gray
	AAA250G4		Black

AAA250G Metal Graphic Insert

Ordering Information

NOTE: If ordering these inserts in the SDC/(CICSPROD) on line parts ordering systems, type in base number:

AAA250G1

AAA250G2

AAA250G3

or AAA250G4

to search for the desired insert marking.

The variations available are too numerous to list in this SPL.

Part Numbering Nomenclature

Four types of parts ( p. 3) with several different markings can currently be ordered through OSC. All part numbers are arranged in one of the following four patterns:

AAA250G1—(Suffix indicating the material/finish & marking)

AAA250G2—(Suffix indicating the material/finish & marking)

AAA250G3—(Suffix indicating the material/finish & marking)

AAA250G4—(Suffix indicating the material/finish & marking)

Example: AAA250G1-UPARROW = a charcoal gray/black insert with a white up-pointing arrow
AAA250G4-SS4-DNARROW = a black insert with a brushed stainless steel finish and down-pointing arrow.

NOTE: Suffixes with no mention of SS4, SS8, BR7, BR8 designations will be the black insert with white characters.







 p. 5 & 6 for some of the most common **AAA250G1, G2, G3, G4** Graphic Inserts examples.



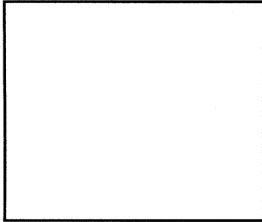
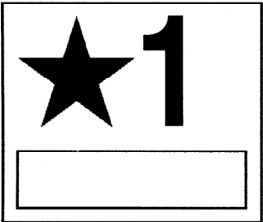

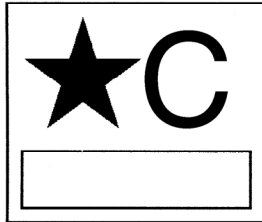
NOTE: Fonts and shapes might slightly differ on the original parts from the ones shown in the illustrations.

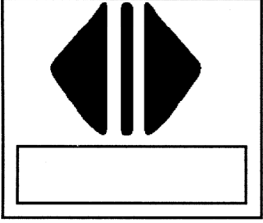
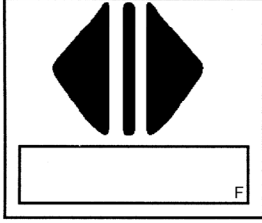
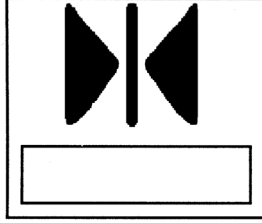
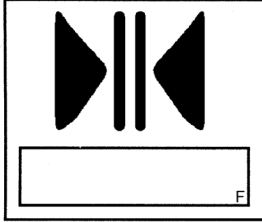
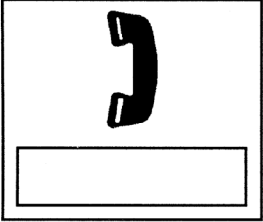
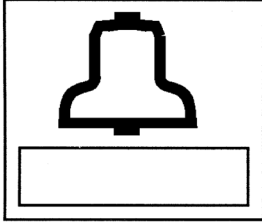
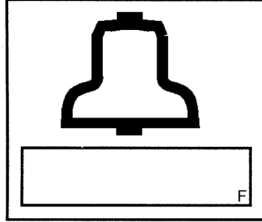
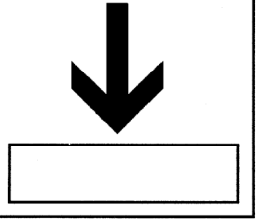
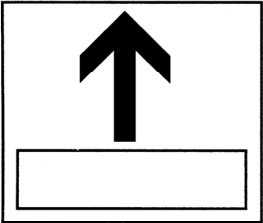
AAA250G Metal Graphic Inserts

31-AAA250G

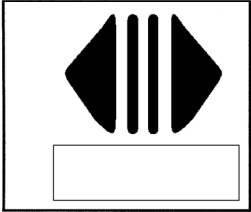
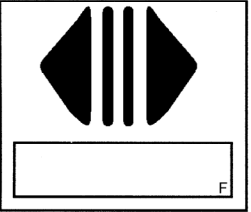
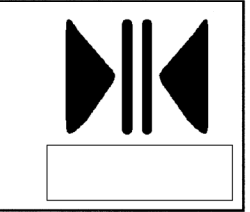
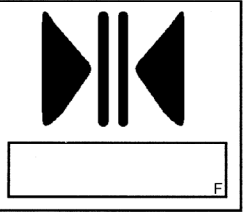
NOTE: For the marking desired per illustration below, fill in the (?) with 1, 2, 3 or 4 based on graphic insert type and color required.  p. 3 for types offered.

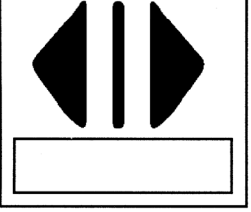
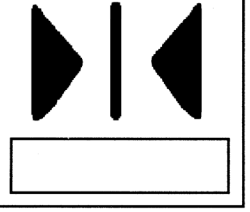
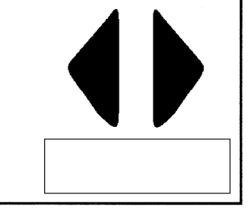
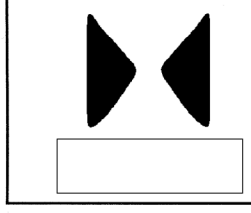
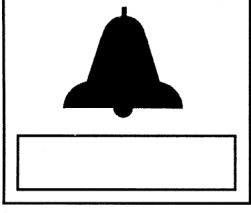
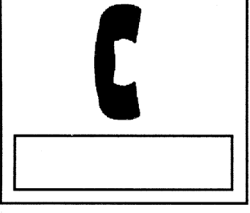
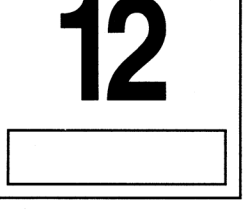
<p>AAA250G?-BLANK</p> 	<p>AAA250G?-ISTAR/1</p> 	<p>AAA250G?-ISTARRC</p>  <p>FRENCH BRAILLE</p>	<p>AAA250G?-ISTARC</p> 
<p>AAA250G?-ISTARG</p> 	<p>AAA250G?-IDO</p> 	<p>AAA250G?-FIDO</p>  <p>FRENCH BRAILLE</p>	<p>AAA250G?-IDC</p> 
<p>AAA250G?-FIDC</p>  <p>FRENCH BRAILLE</p>	<p>AAA250G?-IPHONE</p> 	<p>AAA250G?-IALARM</p> 	<p>AAA250G?-FIALARM</p>  <p>FRENCH BRAILLE</p>
<p>AAA250G?-DNARROW</p> 	<p>AAA250G?-UPARROW</p> 	<p>AAA250G?-STOPKSW</p> 	<p>AAA250G?-STOPTGL</p> 

<p>AAA250G?-REARRDO</p>  <p>[]</p>	<p>AAA250G?-FRDO</p>  <p>[] F</p> <p>FRENCH BRAILLE</p>	<p>AAA250G?-REARRDC</p>  <p>[]</p>	<p>AAA250G?-FRDC</p>  <p>[] F</p> <p>FRENCH BRAILLE</p>
<p>AAA250G?-FSTOPTGL</p>  <p>[] F</p> <p>FRENCH BRAILLE</p>	<p>AAA250G?-IDO2</p>  <p>[]</p>	<p>AAA250G?-IDC2</p>  <p>[]</p>	<p>AAA250G?-REARRDO2</p>  <p>[]</p>
<p>AAA250G?-REARRDC2</p>  <p>[]</p>	<p>AAA250G?-IALARM2</p>  <p>[]</p>	<p>AAA250G?-IPHONE2</p>  <p>[]</p>	<p>AAA250G?-12</p>  <p>[]</p> <p style="text-align: right;">*</p>
<p>AAA250G?-12R</p>  <p>[]</p> <p style="text-align: right;">*</p>	<p>AAA250G?-WHEELCHAIR</p>  <p>[]</p>		

* Alphanumeric markings shown here are only representative examples of alphanumeric type insert markings ranging from 1 to 76. Although current manufacturing capabilities allow for numeral markings 76 and below, higher markings can be special-ordered.

Insert Assemblies

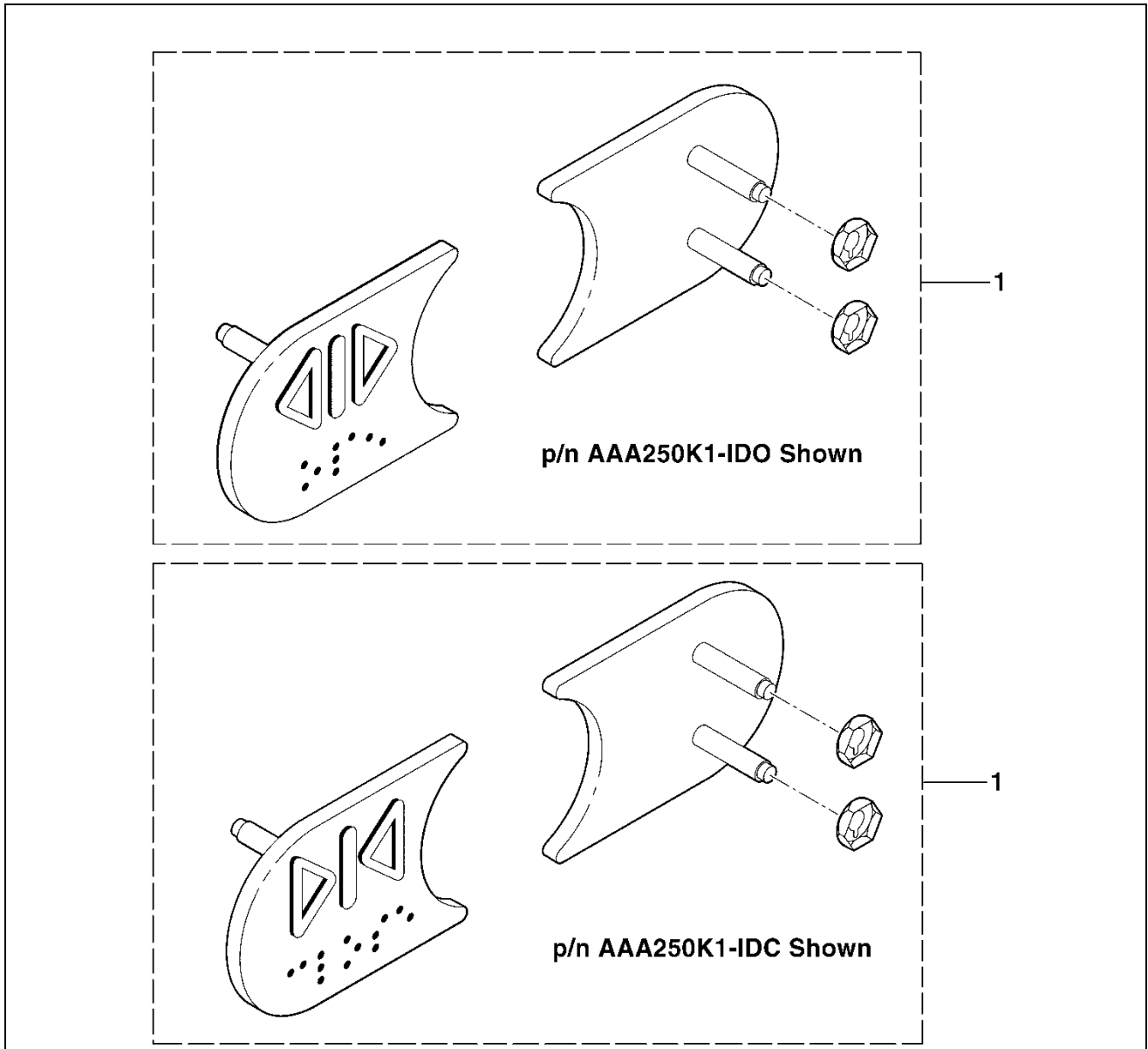

W/O VINTAGE			
REF. No.	PART No.	DESCRIPTION	COLOR
1	AAA250K1	Insert, Graphic, Two AAA72HD1 Self-Threading Nuts for Each Assembly (unassembled), NOTE	Black

NOTE: p. 8, 9 for ordering instructions and some of the most common AAA250K1 graphic insert examples.

AAA250K1 Metal Graphic Insert

Ordering Information

NOTE: If ordering these inserts in the SDC/(CICSPROD) on line parts ordering systems, type in base number **AAA250K1** to search for the desired insert marking.

The variations available are too numerous to list in this SPL.

Part Numbering Nomenclature

AAA250K1 ( p. 7) with several different markings can currently be ordered through OSC. The part numbers are arranged in one of the following two patterns:

AAA250K1—(Suffix indicating marking)

AAA250K1—(Suffix indicating the material/finish & marking)

Example: AAA250K1-UPARROW = a black insert with a white up-pointing arrow

AAA250K1-SS4-DNARROW = a black insert with a brushed stainless steel finish and down-pointing arrow.

NOTE: Suffixes with no mention of SS4 or BR7 designations will be the black insert with white characters.







 p. 9 for some of the most common **AAA250K1** Graphic Insert examples.

NOTE: Fonts and shapes might slightly differ on the original parts from the ones shown in the illustrations.

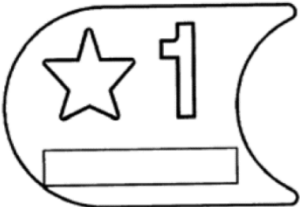
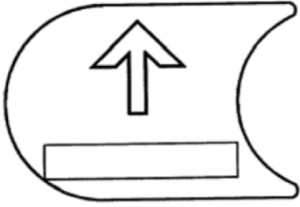
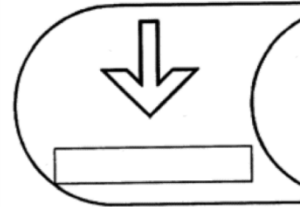
AAA250K1 Metal Graphic Inserts

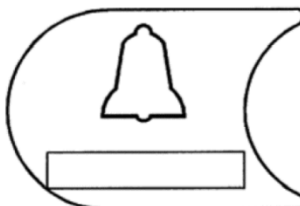
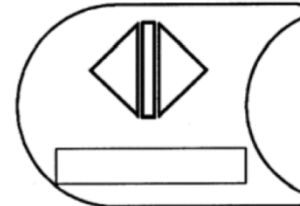
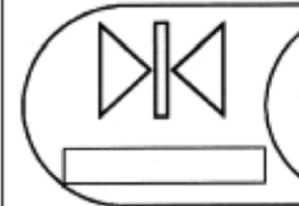
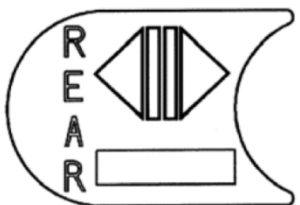
31-AAA250G

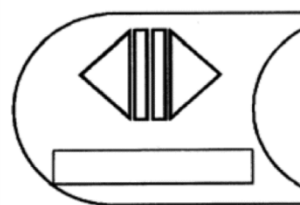
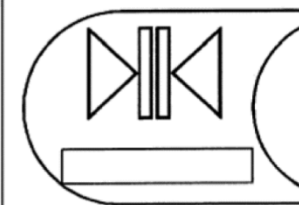
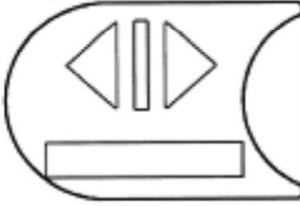
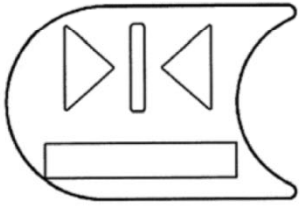
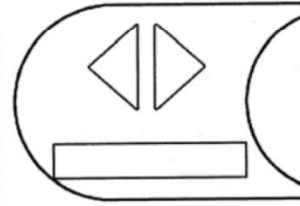
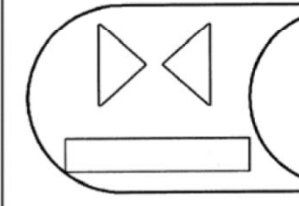
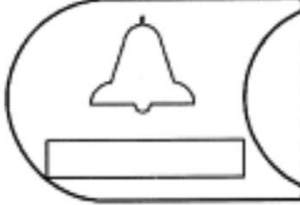
NOTE: These are the most common AAA250K1 graphic insert examples.

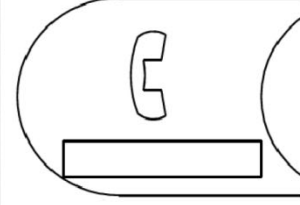
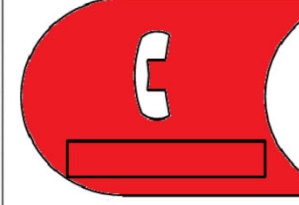
AAA250K1-ISTAR1 	AAA250K1-UPARROW 	AAA250K1-DNARROW 	AAA250K1-STOPTGL 
AAA250K1-STOPKSW 	AAA250K1-IALARM 	AAA250K1-IDO 	AAA250K1-IDC 
AAA250K1-REARRDO 	AAA250K1-REARRDC 	AAA250K1-RDO 	AAA250K1-RDC 
AAA250K1-IDO2 	AAA250K1-IDC2 	AAA250K1-RDO2 	AAA250K1-RDC2 
AAA250K1-IALARM2 	AAA250K1-12* 	AAA250K1-IPHONE2 	AAA250K1-IPHONE3** 

* Alphanumeric markings shown here are only representative examples of alphanumeric type insert markings ranging from 1 to 76. Although current manufacturing capabilities allow for numeral markings 76 and below, higher markings can be special-ordered.

** The AAA250K1-IPHONE3 graphic insert has a red background, as shown above. Standard AAA250K1 graphic inserts have a black background.

Type I: Identification for Black Background and White Character Part

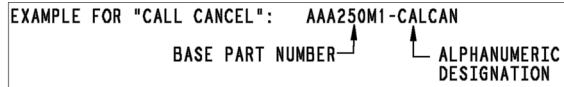

Type II: Identification for Black Background with Plated Character Part

Brushed Stainless Steel = SS4

Brushed Bronze = BR7

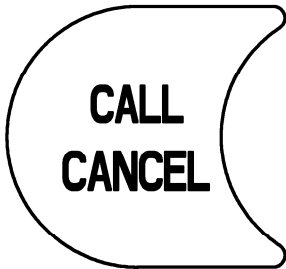
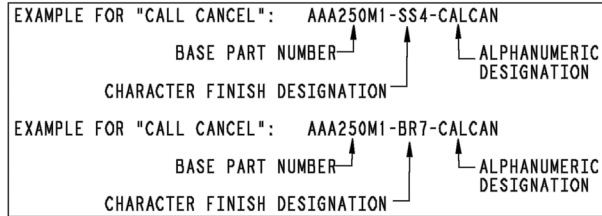

AAA250M1-CALCAN

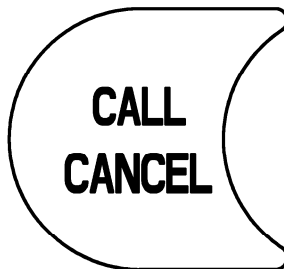

AAA250M1-SS4-CALCAN

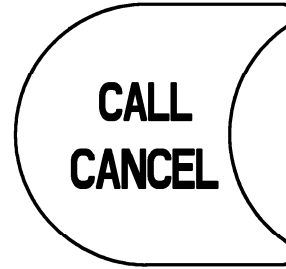

AAA250M1-BR7-CALCAN