

**Door,
Firefighters' Operating Panel
and Compass® Cabinet**

Spare Parts Leaflet

31-AAA406CP

May 17, 2023 / Page 1 of 9

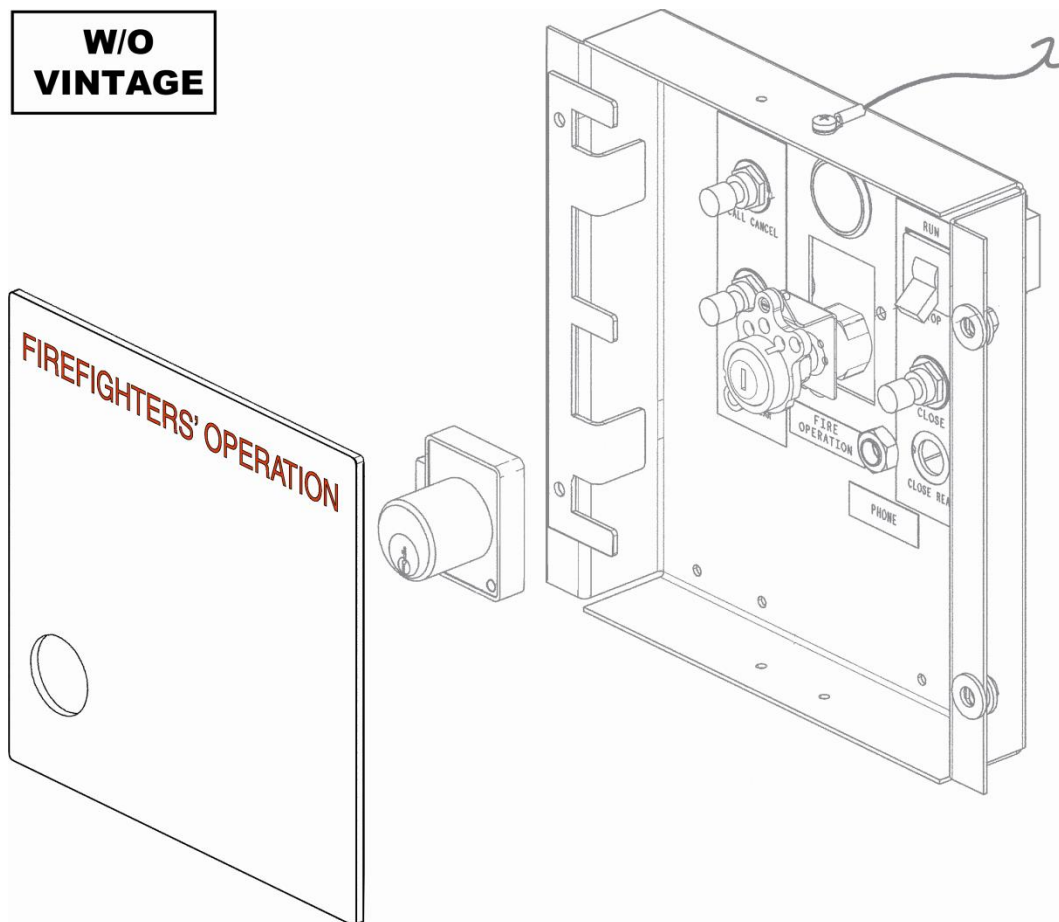

OTIS

This document does not contain any
technical data subject to EAR or ITAR

SERVICE ENGINEERING
Otis Elevator Company
Bloomfield, Connecticut USA

Unpublished Work—© Otis Elevator Co.; 2023

Leaflet Description

This series of doors was introduced to meet lock requirements (type AAA431AQ) of the ANSI 2004 Code for firefighters' cabinet. The doors are used on Luxury Swing, Applied, and Touch Screen and Compass Car Operating Panels.

Leaflet Revisions

Date Revised	Subject Matter Expert	Reason for Revision
February 15, 2017	Joseph Zych and Scott Phillippi	New SPL
April 12, 2017	Joseph Zych and Scott Phillippi	Corrected p/n in Ref. 2 on p. 3
January 17, 2018	Joseph Zych and Scott Phillippi	Updated finish options on p. 3; Inserted new p. 4 for type AAA406DA fire doors
May 17, 2023	Vadzim Fedarenka	Corrected finish option on pp. 3, 4, and 9

Related Drawings

Drawing No.	Title	Drawing No.	Title
AAA406CP	Door, Fire Cabinet	AAA406CY	Door, Compass Cabinet
AAA406CW	Door, Compass Cabinet		

Related Documents

Document ID	Title
SPL 31-AAA25000EN	Luxury Swing Return Car Operating Panel
SPL 31-AAA25000EH	Applied Car Operating Panel
SPL 31-AAA25000EZ	Touch Screen and Compass Car Operating Panel
SPL 31-AAA431AQ	Lock (for fire panels)
SPL 31-AAA317Q	Firefighters' Cabinet and Compass Cabinet
SPL 31-AAA102VB	Instruction Plates

Subject Matter Expert

Name	Department
Vadzim Fedarenka	OSC Service Engineering



About Spare Parts Leaflets...

This document lists the lowest replaceable units (LRUs) for the standard version of the product. The LRUs are chosen by a team of Otis associates representing engineering and manufacturing. While goal of this document is to make parts identification as easy as possible, the document cannot be all-inclusive. Elevator and escalator contracts classified as "special" or "custom" are not addressed here. For such contracts, please refer to specified information, the contract folder, TIPs, Field Education Articles, Construction Letters, etc. for further information. If you have any suggestions about this document, please contact the subject matter expert listed on this page.

Firefighters' Cabinet Door, Type AAA406CP

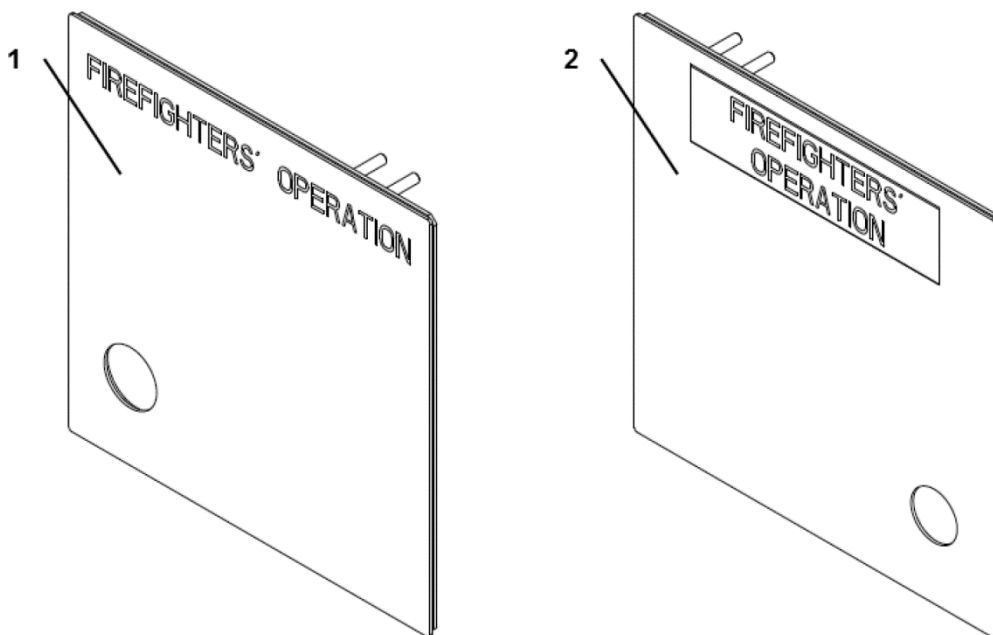
31-AAA406CP



W/O VINTAGE			
REF. No.	PART No.	HAND	DESCRIPTION
1	AAA406CP998-_-_-_-		Assembly, Door, Fire Fighter's Operation (engraved shown)
2	AAA406CP996-_-_-_-		Assembly, Door, Fire Fighter's Operation (label-applied shown)

Available Finishes: Stainless Steel, Mill4 (FS4)
 Stainless Steel, Brushed (MIL4)
 Stainless Steel, Mirror (SS8)
 Stainless Steel, Bronze Tinted (BT)
 Bronze, Brushed (BR7)
 Bronze, Mirror (BR8)
 Bronze, Light Oxidized (LBR)
 Bronze, Dark Oxidized (DBR)

Ordering Example:

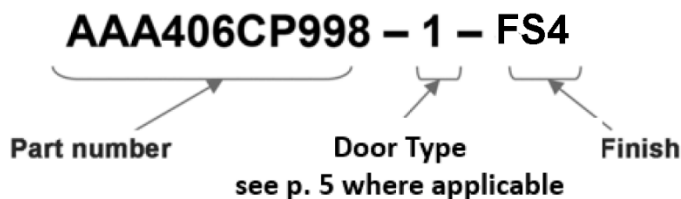

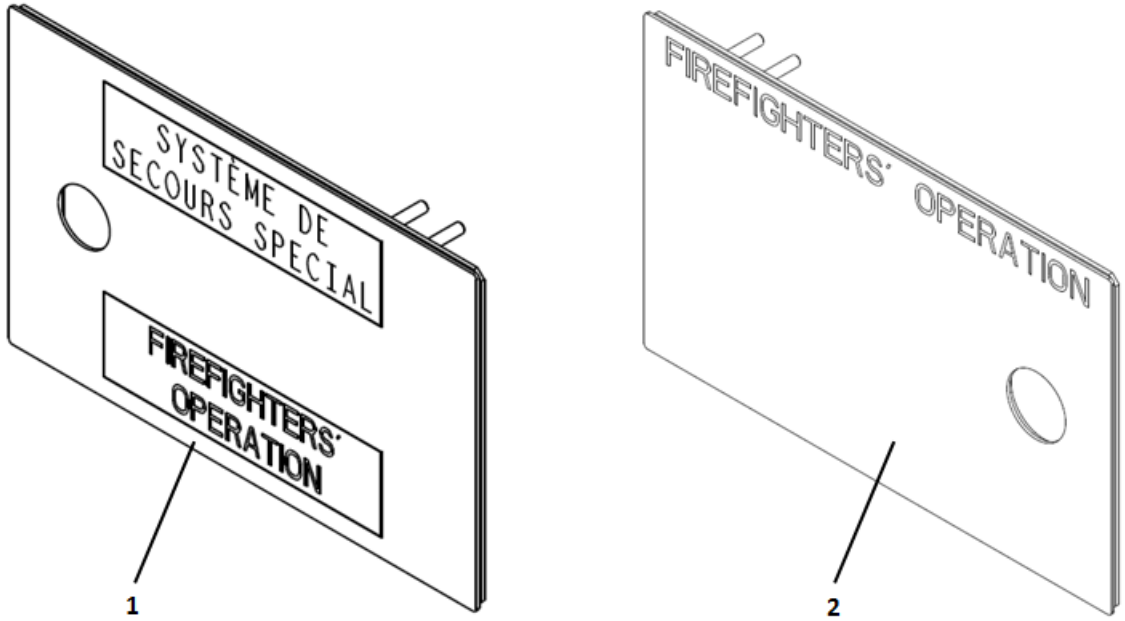

W/O VINTAGE

REF. No.	PART No.	HAND	DESCRIPTION
1	AAA406DA999-_-_-_-		Assembly, Door, Fire Fighter's Operation (label-applied shown)
2	AAA406DA998-_-_-_-		Assembly, Door, Fire Fighter's Operation, (engraved shown)

Available Finishes: Stainless Steel, Mill4 (FS4)
 Stainless Steel, Brushed (MIL4)
 Stainless Steel, Mirror (SS8)
 Stainless Steel, Bronze Tinted (BT)
 Bronze, Brushed (BR7)
 Bronze, Mirror (BR8)
 Bronze, Light Oxidized (LBR)
 Bronze, Dark Oxidized (DBR)

Ordering Example:

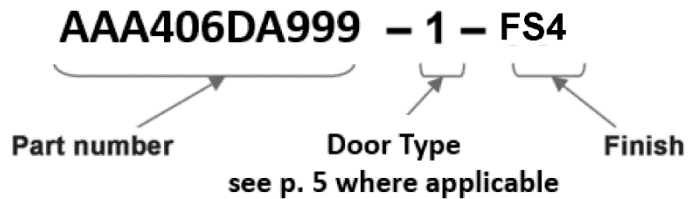

Engraving and Data Plate Options

31-AAA406CP

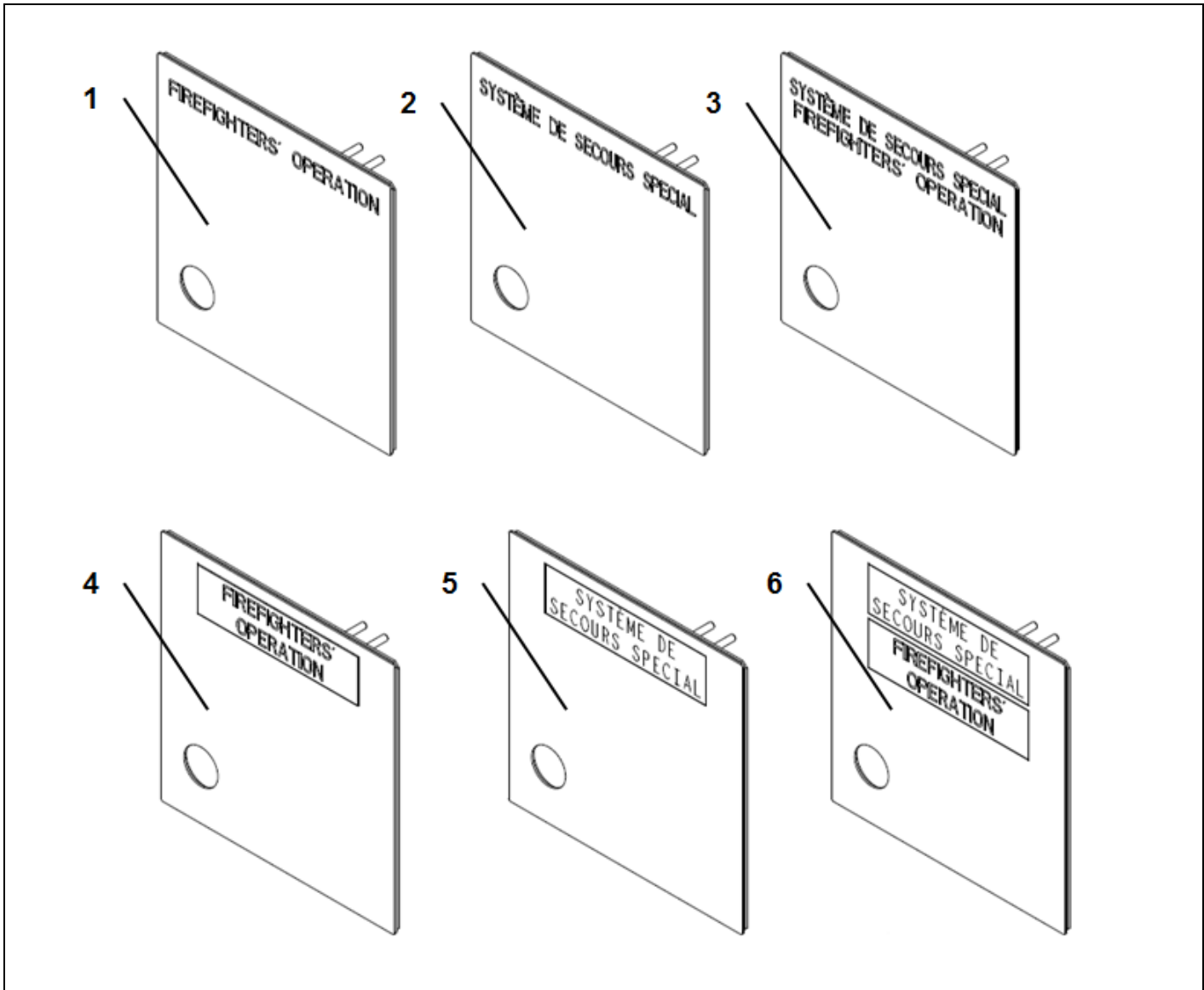

W/O VINTAGE							
Door Type	Engraved Text	Text Language	Door Lock Hole Size	Door Type	Engraved Text	Text Language	Door Lock Hole Size
1	Y	ENGLISH	22.5 mm (0.886 in.)	7	Y	ENGLISH	25.6 mm (1.008 in.)
2	Y	FRENCH		8	Y	FRENCH	
3	Y	ENG/FRE		9	Y	ENG/FRE	
4	N	ENGLISH		10	N	ENGLISH	
5	N	FRENCH		11	N	FRENCH	
6	N	ENG/FRE		12	N	ENG/FRE	

NOTE: All engraving filled red.

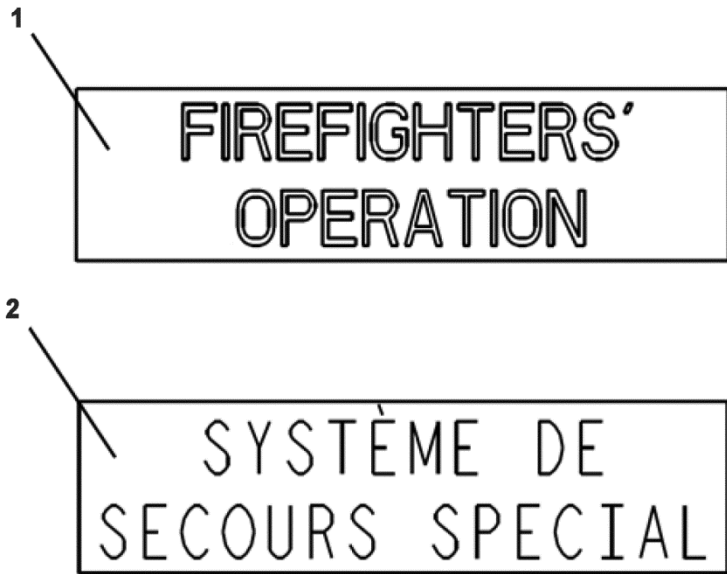



W/O VINTAGE			
REF. NO.	PART NUMBER	DESCRIPTION	FINISH
1	AAA102VB114	Plate, Data, English, "FIREFIGHTERS' OPERATION"	Stainless Steel, Brushed (SS4)
	AAA102VB131		Stainless Steel, Bronze Tinted (BT)
	AAA102VB96		Stainless Steel, Mirror (SS8)
	AAA102VB97		Bronze, Brushed (BR7)
	AAA102VB98		Bronze, Mirror (BR8)
2	AAA102VB115	Plate, Data, French, "FIREFIGHTERS' OPERATION"	Stainless Steel, Mill4 (FS4)
	AAA102VB132		Stainless Steel, Bronze Tinted (BT)

Compass Cabinet Main Door

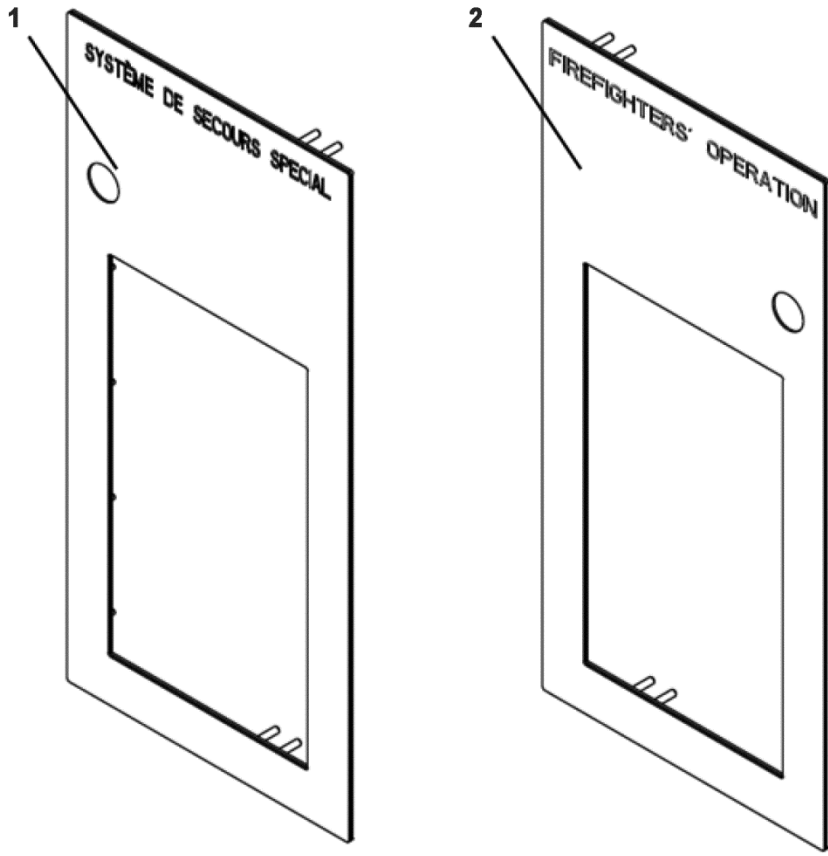
31-AAA406CP



W/O VINTAGE			
REF. No.	PART No.	HAND	DESCRIPTION
1	AAA406CY999 -_-__		Assembly, Compass, Main Door, Contract Specific
2	AAA406CY998-_-__		Assembly, Compass, Main Door, Contract Specific

NOTE: See p. 8 for door types. See p. 4 for available finishes and part number formation example.

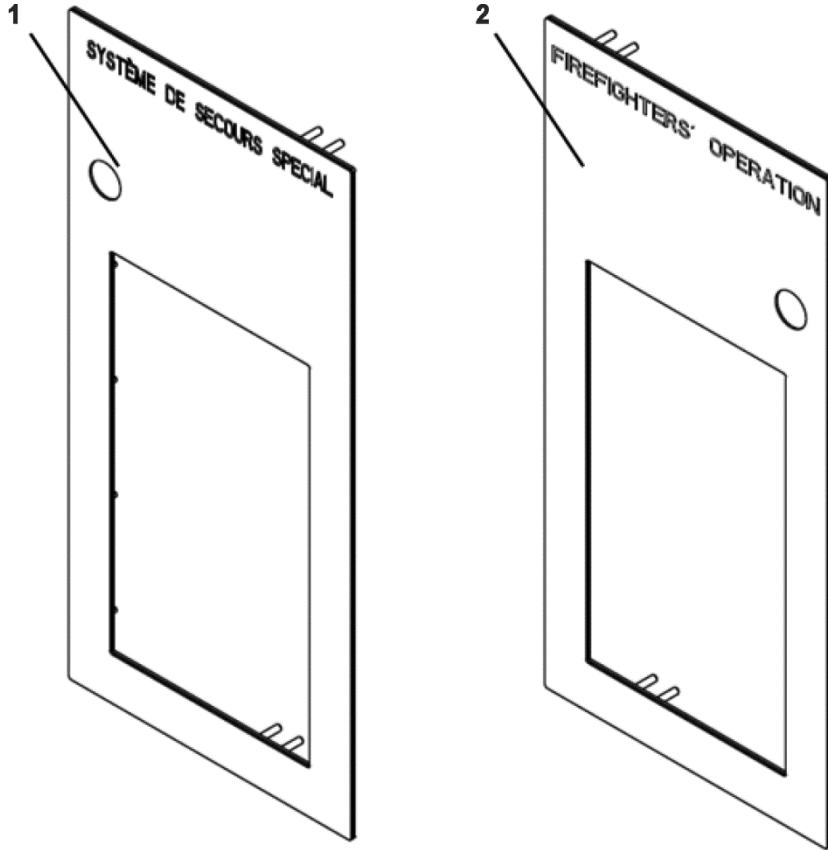

W/O VINTAGE		
Door Type	Text Language	Door Lock Hole Size
1	French	22.5 mm (0.886 in.)
2	English	
3	French	25.6 mm (1.008 in.)
4	English	

Compass Cabinet Inner Door

31-AAA406CP

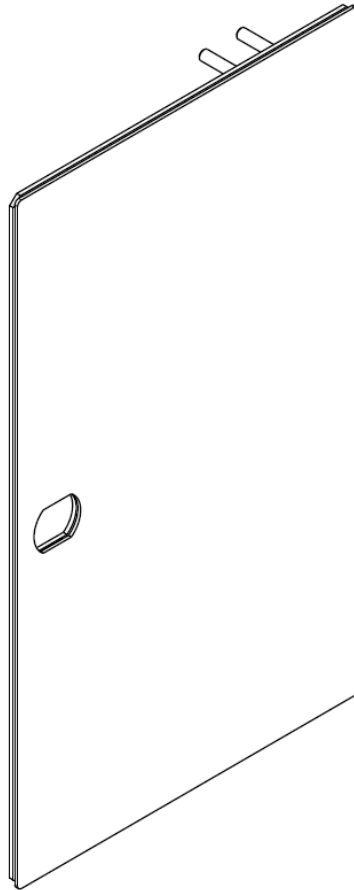

W/O VINTAGE

REF. No.	PART No.	HAND	DESCRIPTION
1	AAA406CW999-__ _	↵ and ↵	Assembly, Compass, Inner Door

Available Finishes: Stainless Steel, Mill4 (FS4)
 Stainless Steel, Brushed (MIL4)
 Stainless Steel, Mirror (SS8)
 Stainless Steel, Bronze Tinted (BT)
 Bronze, Brushed (BR7)
 Bronze, Mirror (BR8)
 Bronze, Light Oxidized (LBR)
 Bronze, Dark Oxidized (DBR)

Ordering Example:

AAA406CW999 - FS4

↵
↵
 Part number Finish