

Advanced Fixtures:
Jewel Modules

Spare Parts Leaflet

31-AAA7069AAR

February 24, 2010 / Page 1 of 6

W/O VINTAGE



Unpublished Work—© Otis Elevator Co.; 2010

OTIS

Safety First!

SERVICE ENGINEERING
Otis Elevator Company
Bloomfield, Connecticut USA

Leaflet Description

Type AAA7069AAR jewel modules were first introduced in the mid-1995 for the LR 95 program (LVM). These jewel modules are used in series 1 fixtures and the LVM hydraulic system.

Leaflet Revisions

Date Revised	Subject Matter Expert	Reason for Revision
August 1997	Katherine Smith	New leaflet
September 26, 2001	John Doane	Add history page, and update parts.
February 24, 2010	Mike Bertini	Add parts AAA7069AAR30–48. Rearrange parts by function and/or title.

Related Drawings

Drawing No.	Title	Drawing No.	Title
AAA7069AAR	Jewel Module		

Related Documents

Document ID	Title
SPL 31-AAA7069AAS	Button Module, Advanced Type
SPL 31-AAA7155BY	Car Operating Panel, Series 1, 3-Column

Subject Matter Expert

Name	Department
Mike Bertini	OSC Service Engineering

About Spare Parts Leaflets...

This document lists the lowest replaceable units (LRUs) for the standard version of the product. The LRUs are chosen by a team of Otis associates representing engineering and manufacturing.





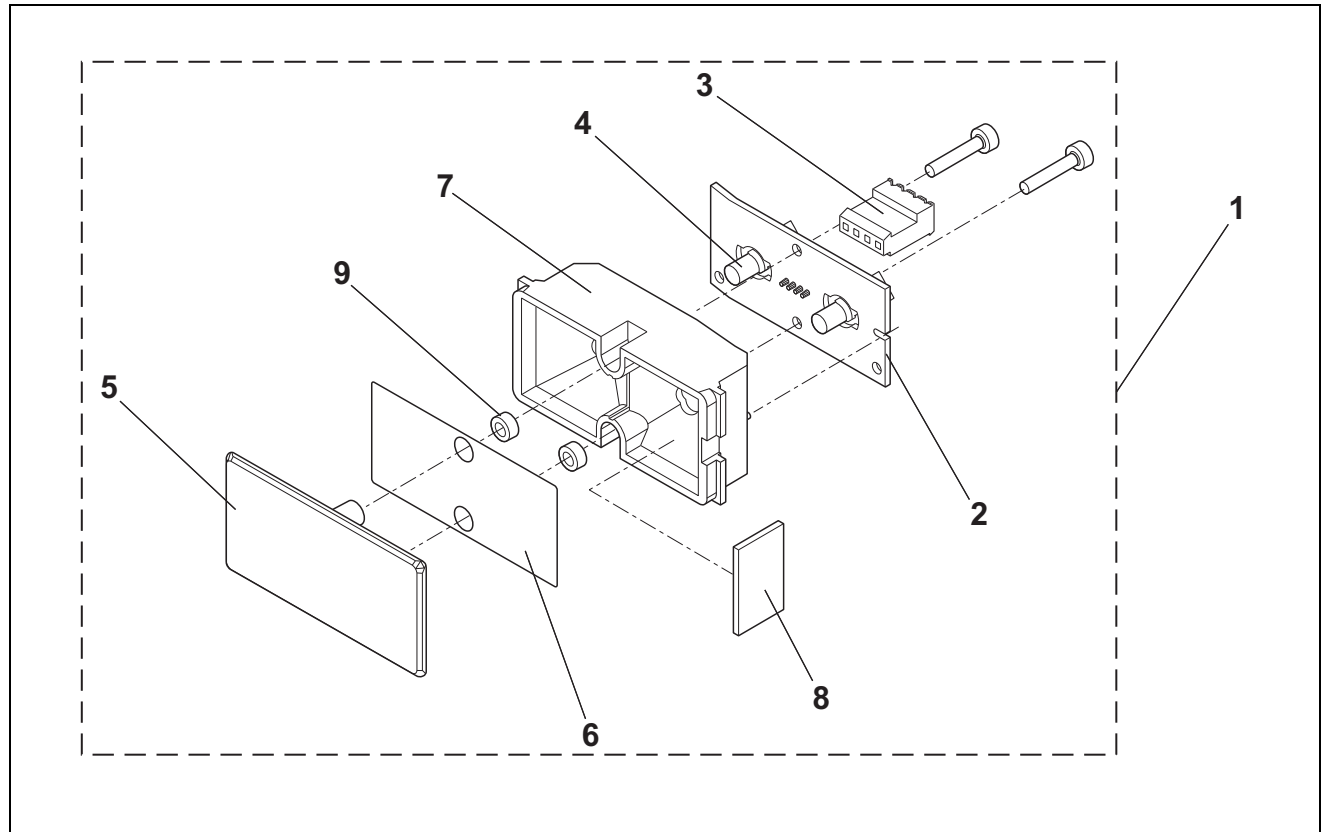



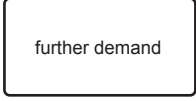
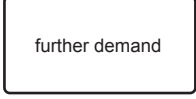
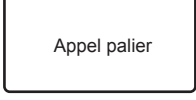

While goal of this document is to make parts identification as easy as possible, the document cannot be all-inclusive. Elevator and escalator contracts classified as “special” or “custom” are not addressed here. For such contracts, please refer to specified information, the contract folder, TIPs, Field Education Articles, Construction Letters, etc. for further information.

If you have any suggestions about this document, please contact the subject matter expert listed on this page.

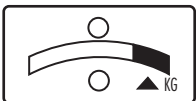
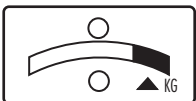

REF. No.	W/O VINTAGE PART No.	DESCRIPTION
1	---	Assembly, Type AAA7069AAR Jewel Module, pp. 4–6 for Details
2	AAA26800TX1	Assembly, Jewel Module PCB, 28.0 V (require 2 of p/n 424R1)
	AAA26800TX2	Assembly, Jewel Module PCB, 6.3 V (require 2 of p/n 424R4)
3	AAA447AC3	Connector, 4-Circuits, for Hall Modules
4	424R1	Lamp, Type 85, 28.0 V, Bulb Style T-1 3/4
	424R4	Lamp, Type 86, 6.3 V, Bulb Style T-1 3/4
	AAA629AY2	LED, Red, 30 V, Bulb Style T 1 3/4, Red Lens Only
5	443CB6	Lens, Blue
	443CB2	Lens, Clear
	443CB1	Lens, Red
		pp. 4–6
6	---	Mask, pp. 4–6, and SPL 31-449BJ, Type 449 BJ Mask, for Detailed Listing
7	278FA1	Reflector, Jewel
8	278FA2	Shield, Part of Reflector 278FA1, NOTE
9	AAA129DW9	Washer, Nylon (screw size 4)







NOTE: 278FA2 is molded as part of reflector 278FA1. Discard if not required.

FUNCTION/TITLE	MASK		LENS		ASSEMBLY
Alarm (hall)		449BJ72	Red	443CB1	AAA7069AAR10
Alarm (Province of Quebec) (car 6 V)		449BJ90	Red	443CB1	AAA7069AAR11
Alarm Received (car)		449BJ75	Red	443CB1	AAA7069AAR9
Attendant Service (car)		449BJ4	Red	443CB1	AAA7069AAR15
Attendant Service (car)		449BJ4	Clear Natural	443CB2	AAA7069AAR36
Attendant Service (car) (French)		449BJ22	Red	443CB1	AAA7069AAR16
Blank		449BJ1	Clear Natural	443CB2	AAA7069AAR1
Blank with Housing		---	---	---	AAA7069AAR40
Blank without Housing		---	---	---	AAA7069AAR41
Car Overload		449BJ8	Red	443CB1	AAA7069AAR4
Car Overload		449BJ8	Clear Natural	443CB2	AAA7069AAR34
Direction Arrow		449BJ92	Clear Natural	443CB2	AAA7069AAR2
Direction Arrow		449BJ67	Clear	443CB2	AAA7069AAR32
Emergency		449BJ66	Red	443CB1	AAA7069AAR22

AAA7069AAR Jewel Assembly

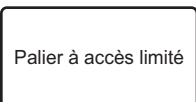
31-AAA7069AAR

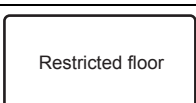
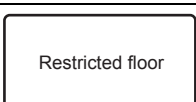
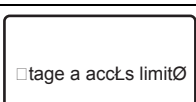
FUNCTION/TITLE	MASK		LENS		ASSEMBLY
Emergency Power Verbage (French/English)		---	---	---	AAA7069AAR49
Emergency Recall		449BJ64	Red	443CB1	AAA7069AAR29
Emergency Recall (B44) (French Canada)		449BJ62	Red	443CB1	AAA7069AAR30
Emergency Service (car)		449BJ3	Red	443CB1	AAA7069AAR23
Emergency Service (car)		449BJ3	Clear Natural	443CB2	AAA7069AAR38
Emergency Service (car) (Fire/Hospital prior ETO French)		449BJ12	Red	443CB1	AAA7069AAR24
Emergency Service (Province of Quebec)		449BJ89	Red	443CB1	AAA7069AAR25
Further Demand (French)		449BJ96	Red	443CB1	AAA7069AAR44
Further Demand (French/English)		449BJ104	Red	443CB1	AAA7069AAR48
Medical Emergency (MA)		449BJ70	Blue	443CB6	AAA7069AAR18
Medical Emergency (MA)		449BJ70	Clear Natural	443CB2	AAA7069AAR37
Please Exit (French/English)		449BJ69	Red	443CB1	AAA7069AAR45
Power (car) (MG pilot)		449BJ6	Red	443CB1	AAA7069AAR12
Priority Service		449BJ9	Red	443CB1	AAA7069AAR3

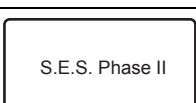
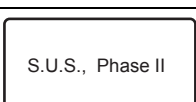
FUNCTION/TITLE	MASK		LENS		ASSEMBLY
Priority Service		449BJ9	Clear Natural	443CB2	AAA7069AAR33
Priority Service (French)		449BJ69	Red	443CB1	AAA7069AAR43
Priority Service (French/English)		449BJ86	Red	443CB1	AAA7069AAR47
Restricted Floor (French)		449BJ93	Red	443CB1	AAA7069AAR42
Restricted Floor (French/English)		449BJ99	Red	443CB1	AAA7069AAR46
Security (car)		449BJ2	Red	443CB1	AAA7069AAR5
Security (car)		449BJ2	Clear Natural	443CB2	AAA7069AAR35
Security (Province of Quebec)		449BJ78	Red	443CB1	AAA7069AAR6
SES Phase I (fire hat)		449BJ68	Red	443CB1	AAA7069AAR26
SES Phase I (fire hat)		449BJ68	Clear Natural	443CB2	AAA7069AAR39
SES Phase II		449BJ76	Red	443CB1	AAA7069AAR27
SES Phase II (Province of Quebec)		449BJ79	Red	443CB1	AAA7069AAR28