

**Luxury Micro-Motion III
Pushbuttons
(Vandal-Resistant)**

**Spare Parts Leaflet
32-AAA23500AM**

April 26, 2023 / Page 1 of 11

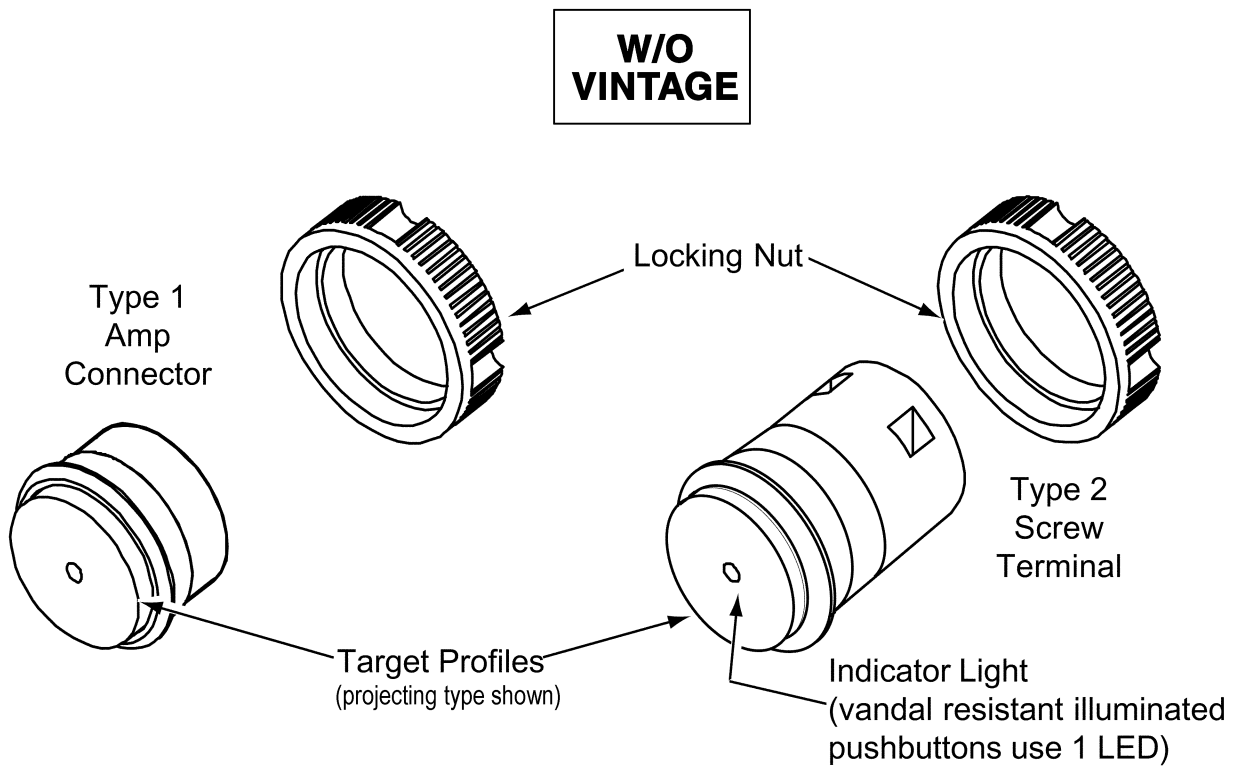

OTIS

This document does not contain any
technical data subject to EAR or ITAR

**SERVICE ENGINEERING
Otis Elevator Company
Bloomfield, Connecticut USA**

Unpublished Work—© Otis Elevator Co.; 2023

32-AAA23500AM

History

Leaflet Description

This leaflet describes the vandal-resistant types AAA23500AM, AAA23500BZ, and AAA323DZ Series III, micro-motion (MM-III) pushbuttons.

Leaflet Revisions

Date Revised	Subject Matter Expert	Reason for Revision
May 22, 2006	---	AAA23500AM buttons were included in SPL 31-AAA23500AK so SPL 31-AAA23500AM was made into a pointer to the -AK SPL.
January 22, 2014	Joseph Zych	All buttons in SPL 31-AAA23500AK are now obsolete except the AAA23500AM buttons, so they are being returned to this SPL. AAA23500BZ buttons are also being removed from 31-AAA23500BY and put into this SPL. Also changing to component code 32.
February 4, 2015	Joseph Zych	Corrected description for p/n AAA23500AM43.
May 13, 2015	Joseph Zych	Added target profile information for type AAA23500AM and type AAA23500BZ buttons
June 8, 2022	Vadzim Fedarenka	Updated History page; Added AAA323DZ and style pictures on pp.3–10; AAA23500BZ buttons replaced by AAA323DZ on pp.3–10
April 26, 2023	Vadzim Fedarenka	Updated Overall Length and Connector type on pp.3–10; Added NOTE

Related Drawings

Drawing No.	Title	Drawing No.	Title
AAA23500AM	Pushbutton, Vandal-Resistant Micro-Motion III	AAA323DZ	Pushbutton, Vandal-Resistant Micro-Motion III
AAA23500BZ	Pushbutton, Vandal-Resistant Micro-Motion III		

Related Documents

Document ID	Title
SPL 32-AAA323DZ	Push Button, Luxury Micro Motion III (Vandal Resistant)

Subject Matter Expert

Name	Department
Vadzim Fedarenka	OSC Service Engineering

About Spare Parts Leaflets...

This document lists the lowest replaceable units (LRUs) for the standard version of the product. The LRUs are chosen by a team of Otis associates representing engineering and manufacturing.

While goal of this document is to make parts identification as easy as possible, the document cannot be all-inclusive. Elevator and escalator contracts classified as "special" or "custom" are not addressed here. For such contracts, please refer to specified information, the contract folder, TIPs, Field Education Articles, Construction Letters, etc. for further information.

If you have any suggestions about this document, please contact the subject matter expert listed on this page.

MM III Pushbutton: Flat Flush, SS4 / FS4 Finishes

32-AAA23500AM

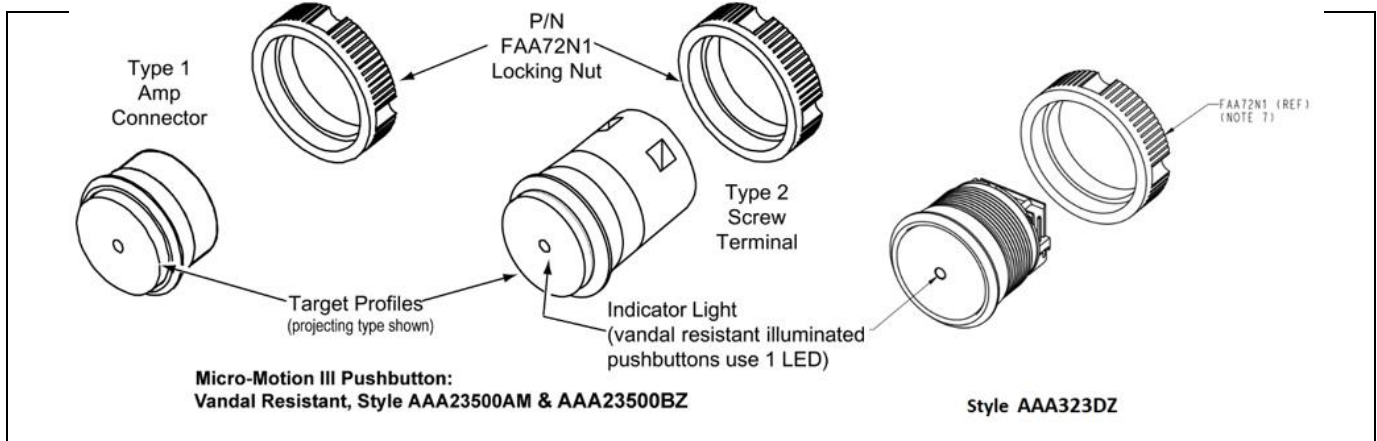

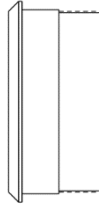
Part No.	Indicator Light Color	Overall Length	Voltage Rating	Style	No. of Contacts	Connector	Finish
AAA23500AM4	Non-Illuminating	19 mm	24 VDC	Flat Flush 	N/A	Amp	SS4 / FS4
AAA23500AM39	Blue						
AAA23500AM42	Green						
AAA23500AM1	Red						
AAA23500AM57	White						
AAA23500BZ34 AAA323DZ11315	Blue	33 mm	24 VDC		1	Screw	
AAA23500AM37 AAA23500BZ5 AAA323DZ11412	Amber	33 mm	30 VDC				
AAA23500AM25 AAA23500BZ6 AAA323DZ11512	Amber	33 mm	120 VAC		2	AMP	
AAA23500AM29 AAA23500BZ7 AAA323DZ11512	Amber	33 mm	120 VDC				
AAA23500AM33 AAA23500BZ8 AAA323DZ11527	Non-Illuminating	33 mm	120 V Max		2	AMP	
AAA23500AM7 AAA23500BZ1 AAA23500AM13 AAA23500BZ2 AAA323DZ11141*	Red	28.4 mm	6 VDC				
AAA23500AM10 AAA23500BZ3 AAA23500AM16 AAA23500BZ4 AAA323DZ11241*	Red	28.4 mm	12 VDC	2	AMP		

***NOTE:** AAA174YL23 cable required with AAA323DZ button replacement.

32-AAA23500AM

MM III Pushbutton: Flat Flush BR7 / BT Finishes

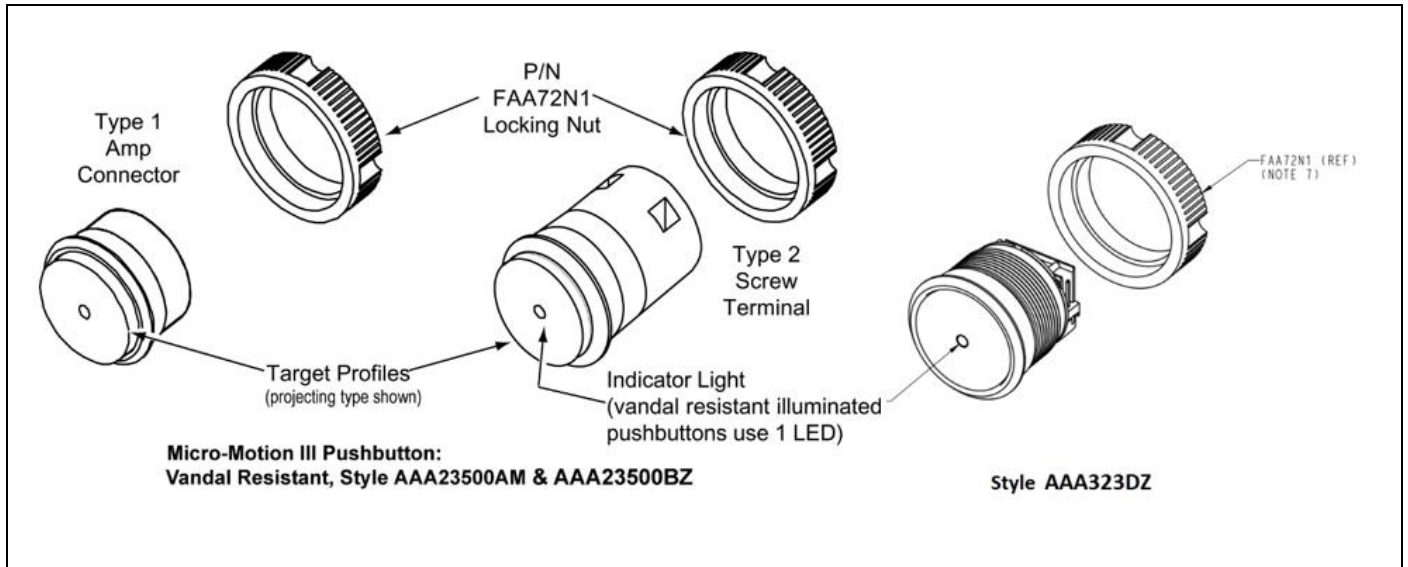

Part No.	Indicator Light Color	Overall Length	Voltage Rating	Style	No. of Contacts	Connector	Finish	
AAA23500AM47	Non-Illuminating	19 mm	24 VDC	Flat Flush	N/A	Amp	BR7	
AAA23500AM52	Blue							
AAA23500AM55	Green							
AAA23500AM44	Red							
AAA23500AM59	White							
AAA23500AM61	White	19 mm	24 VDC		N/A	Amp	BT	
AAA23500BZ34 AAA323DZ13141*	Red	28.4 mm	6 VDC		Flat Flush	2	AMP	BR7
AAA23500BZ35 AAA323DZ13141*	Red	28.4 mm	6 VDC			2	AMP	
AAA23500BZ36 AAA323DZ13241*	Red	28.4 mm	12 VDC			2	AMP	
AAA23500BZ37 AAA323DZ13241*	Red	28.4 mm	12 VDC			2	AMP	
AAA23500BZ38 AAA323DZ13412	Amber	33 mm	30 VDC	1		Screw		
AAA23500BZ39 AAA323DZ13512	Amber	33 mm	120 VAC	1				
AAA23500BZ40 AAA323DZ13512	Amber	33 mm	120 VDC	1				
AAA23500BZ44 AAA323DZ13527	Non-Illuminating	33 mm	120 V Max	2				

*NOTE: AAA174YL23 cable required with AAA323DZ button replacement.

MM III Pushbutton: Flat Projecting SS4 / FS4 Finishes

32-AAA23500AM

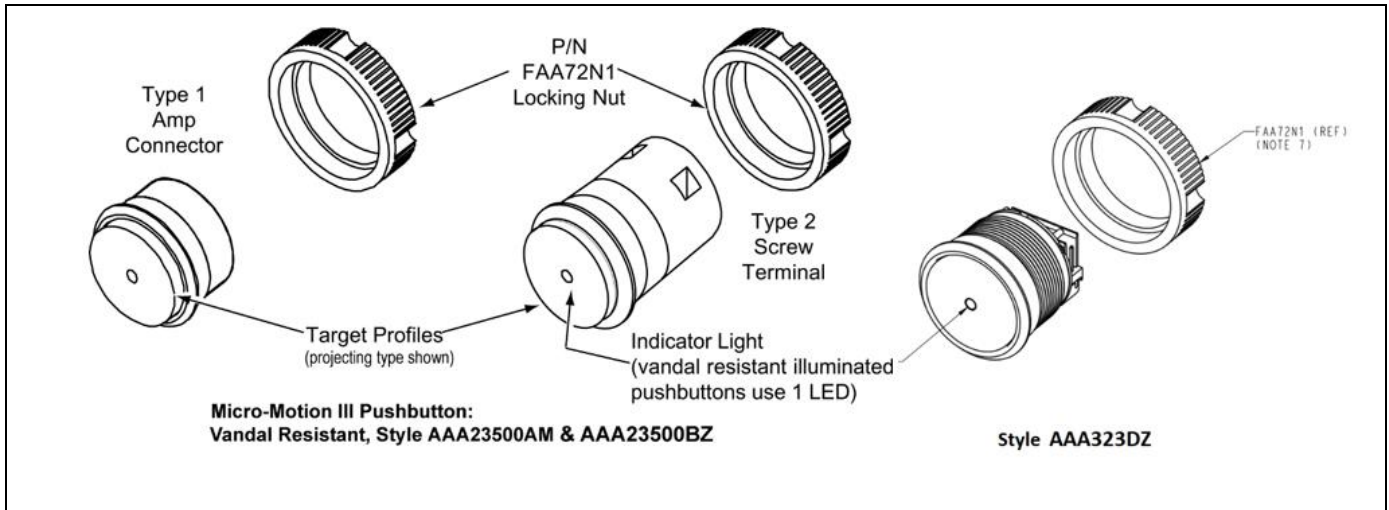

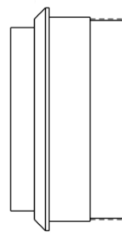
Part No.	Indicator Light Color	Overall Length	Voltage Rating	Style	No. of Contacts	Connector	Finish
AAA23500AM5	Non-Illuminating	19 mm	24 VDC	Flat Projecting 	N/A	Amp	SS4 / FS4
AAA23500AM40	Blue						
AAA23500AM2	Red						
AAA23500AM58	White						
AAA23500AM43	Green						
AAA23500AM38 AAA23500BZ13 AAA323DZ21412	Amber	33 mm	30 VDC		1	Screw	
AAA23500AM26 AAA23500BZ14 AAA323DZ21512	Amber	33 mm	120 VAC				
AAA23500AM30 AAA23500BZ15 AAA323DZ21512	Amber	33 mm	120 VDC		2	AMP	
AAA23500BZ32 AAA323DZ21315	Blue	33 mm	24 VDC				
AAA23500AM34 AAA23500BZ16 AAA323DZ21527	Non-Illuminating	33 mm	120 V Max		2	AMP	
AAA23500AM8 AAA23500BZ9 AAA323DZ21141*	Red	28.4 mm	6 VDC				
AAA23500AM14 AAA23500BZ10 AAA323DZ21141*	Red	28.4 mm	6 VDC		2	AMP	
AAA23500AM11 AAA23500BZ11 AAA323DZ21241*	Red	28.4 mm	12 VDC				
AAA23500AM17 AAA23500BZ12 AAA323DZ21241*		28.4 mm					

***NOTE:** AAA174YL23 cable required with AAA323DZ button replacement.

32-AAA23500AM

MM III Pushbutton: Flat Projecting BR7 / BT Finishes

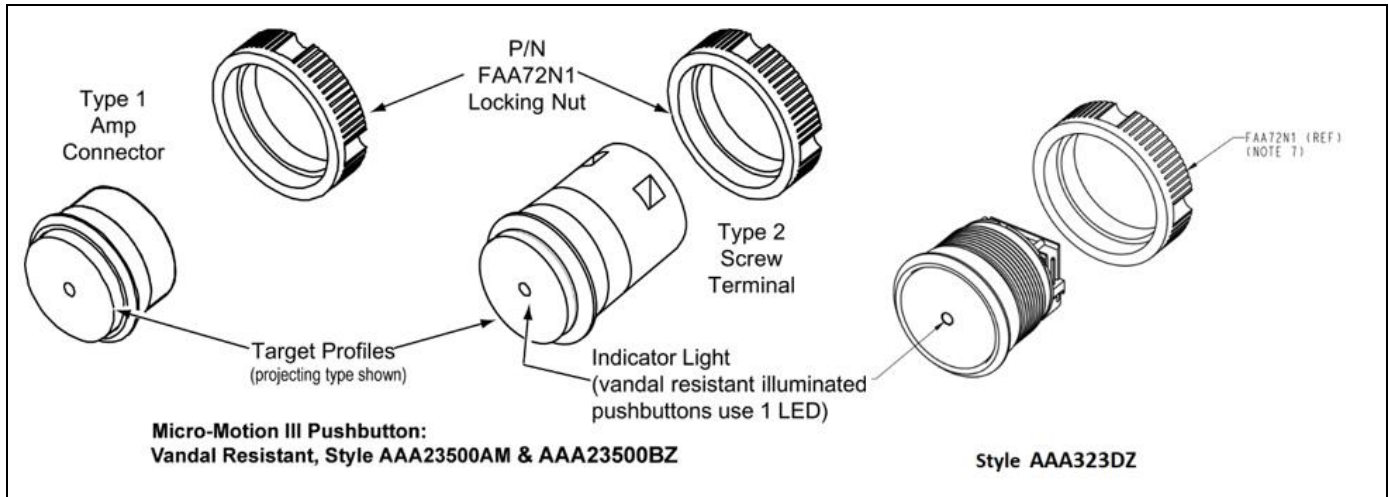

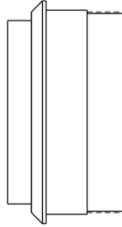
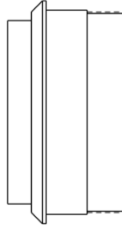
Part No.	Indicator Light Color	Overall Length	Voltage Rating	Style	No. of Contacts	Connector	Finish	
AAA23500AM48	Non-Illuminating	19 mm	24 VDC	Flat Projecting 	N/A	Amp	BR7	
AAA23500AM53	Blue							
AAA23500AM56	Green							
AAA23500AM45	Red							
AAA23500AM60	White							
AAA23500AM62	White	19 mm	24 VDC		N/A	Amp	BT	
AAA23500BZ42 AAA323DZ23141*	Red	28.4 mm	6 VDC		Flat Projecting 	2	AMP	BR7
AAA23500BZ43 AAA323DZ23141*	Red	28.4 mm				2	AMP	
AAA23500BZ44 AAA323DZ23241*	Red	28.4 mm	12 VDC			2	AMP	
AAA23500BZ45 AAA323DZ23241*	Red	28.4 mm				2	AMP	
AAA23500BZ46 AAA323DZ23412	Amber	33 mm	30 VDC	1		Screw		
AAA23500BZ47 AAA323DZ23512	Amber	33 mm	120 VAC	1				
AAA23500BZ48 AAA323DZ23512	Amber	33 mm	120 VDC	1				
AAA23500BZ49 AAA323DZ23527	Non-Illuminating	33 mm	120 V Max	2				

*NOTE: AAA174YL23 cable required with AAA323DZ button replacement.

MM III Pushbutton: Concave Flush SS4 / FS4 Finishes

32-AAA23500AM

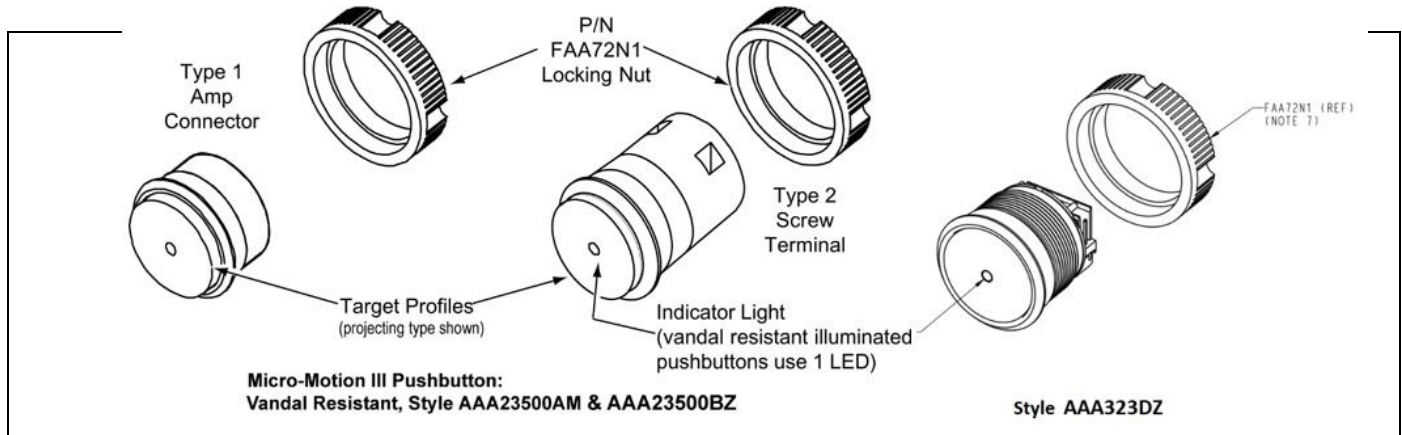

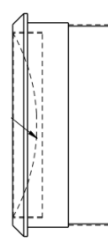
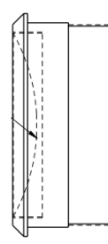
Part No.	Indicator Light Color	Overall Length	Voltage Rating	Style	No. of Contacts	Connector	Finish		
AAA23500AM6	Non-Illuminating	19 mm	24 VDC	Concave Flush 	N/A	Amp	SS4 / FS4		
AAA23500AM41	Blue								
AAA23500AM3	Red								
AAA23500AM27 AAA23500BZ24 AAA323DZ31512	Amber	33 mm	120 VAC		Concave Flush 	1		Screw	SS4 / FS4
AAA23500AM34 AAA23500BZ22 AAA323DZ31512	Amber	33 mm	120 VDC						
AAA23500BZ33 AAA323DZ31315	Blue	33 mm	24 VDC						
AAA23500AM35 AAA23500BZ23 AAA323DZ31527	Non-Illuminating	33 mm	120 V Max						
AAA23500AM9 AAA23500BZ17 AAA323DZ31141	Red	28.4 mm	6 VDC						
AAA23500AM15 AAA23500BZ18 AAA323DZ31141	Red	28.4 mm	6 VDC						
AAA23500AM12 AAA23500BZ49 AAA323DZ31241	Red	28.4 mm	12 VDC						
AAA23500AM18 AAA23500BZ20 AAA323DZ31241	Red	28.4 mm	12 VDC						

***NOTE:** AAA174YL23 cable required with AAA323DZ button replacement.

32-AAA23500AM

**MM III Pushbutton: Concave Flush
BR7 Finish**

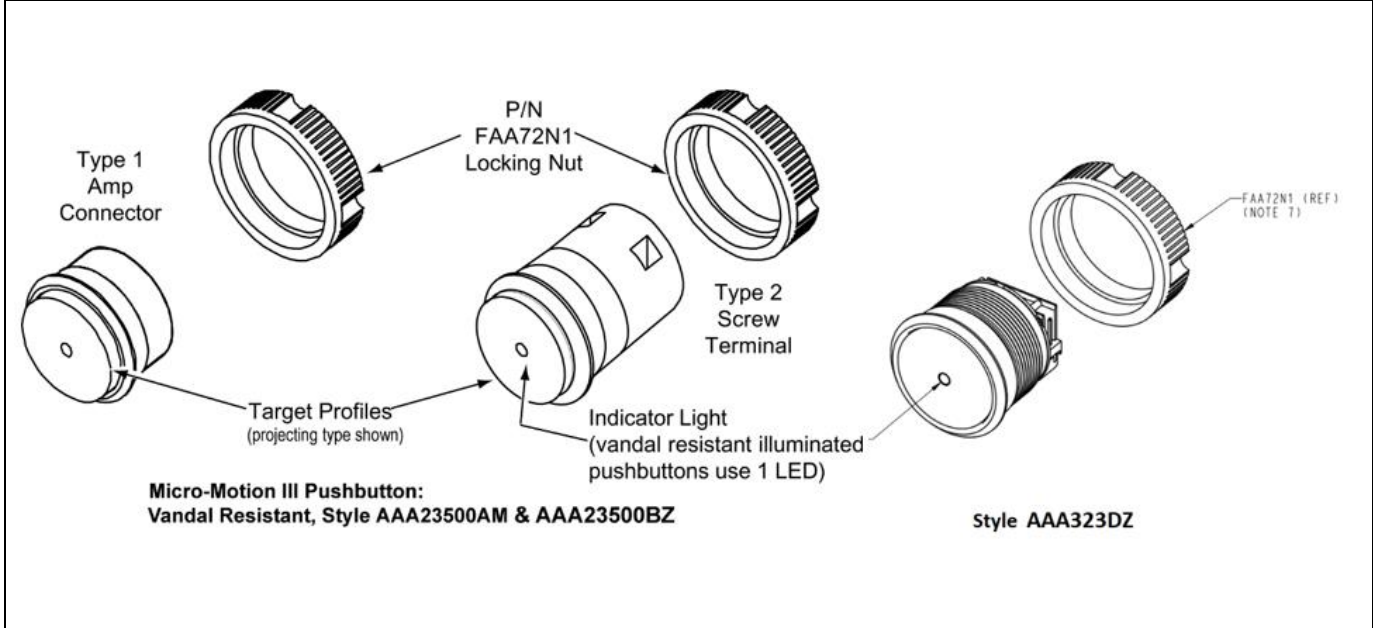

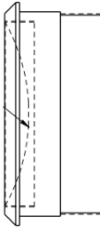
Part No.	Indicator Light Color	Overall Length	Voltage Rating	Style	No. of Contacts	Connector	Finish
AAA23500AM49	Non-Illuminating	19 mm	24 VDC	Concave Flush 	N/A	Amp	BR7
AAA23500AM54	Blue						
AAA23500AM46	Red						
AAA23500BZ54 AAA323DZ33512	Amber	33 mm	120 VAC		1	Screw	
AAA23500BZ55 AAA323DZ33512	Amber	33 mm	120 VDC		2		
AAA23500BZ56 AAA323DZ33527	Non-Illuminating	33 mm	120 V Max		2	AMP	
AAA23500BZ50 AAA323DZ33141*	Red	28.4 mm	6 VDC		2	AMP	
AAA23500BZ51 AAA323DZ33141*	Red	28.4 mm	6 VDC		2	AMP	
AAA23500BZ52 AAA323DZ33241*	Red	28.4 mm	12 VDC		2	AMP	
AAA23500BZ53 AAA323DZ33241*	Red	28.4 mm	12 VDC		2	AMP	

*NOTE: AAA174YL23 cable required with AAA323DZ button replacement.

MM III Pushbutton: Concave Projecting

SS4 / FS4 Finishes

32-AAA23500AM

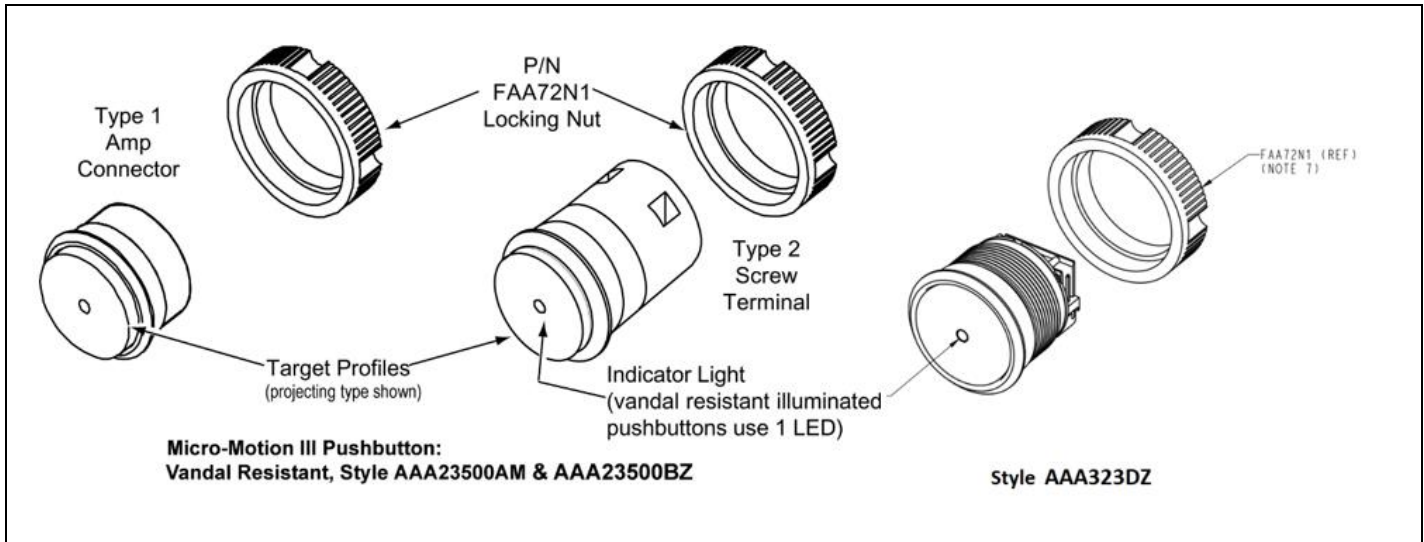

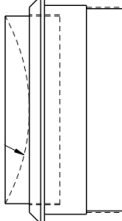
Part No.	Indicator Light Color	Overall Length	Voltage Rating	Style	No. of Contacts	Connector	Finish
AAA23500AM20	Non-Illuminating	19 mm	24 VDC	Concave Projecting 	N/A	Amp	SS4 / FS4
AAA23500AM19	Red	19 mm					
AAA23500AM28 AAA23500BZ28 AAA323DZ41512	Amber	33 mm	120 VAC		1	Screw	
AAA23500AM32 AAA23500BZ29 AAA323DZ41512	Amber	33 mm	120 VDC		2	Screw	
AAA23500AM36 AAA23500BZ30 AAA323DZ41527	Non-Illuminating	33 mm	120 V Max		2	AMP	
AAA23500AM23 AAA23500BZ24 AAA323DZ41141*	Red	28.4 mm	6 VDC		2	AMP	
AAA23500AM21 AAA23500BZ25 AAA323DZ41141*	Red	28.4 mm	6 VDC		2	AMP	
AAA23500AM24 AAA23500BZ26 AAA323DZ41241*	Red	28.4 mm	12 VDC		2	AMP	
AAA23500AM22 AAA23500BZ27 AAA323DZ41241*	Red	28.4 mm	12 VDC		2	AMP	

***NOTE:** AAA174YL23 cable required with AAA323DZ button replacement.

32-AAA23500AM

MM III Pushbutton: Concave Projecting BR7 Finish

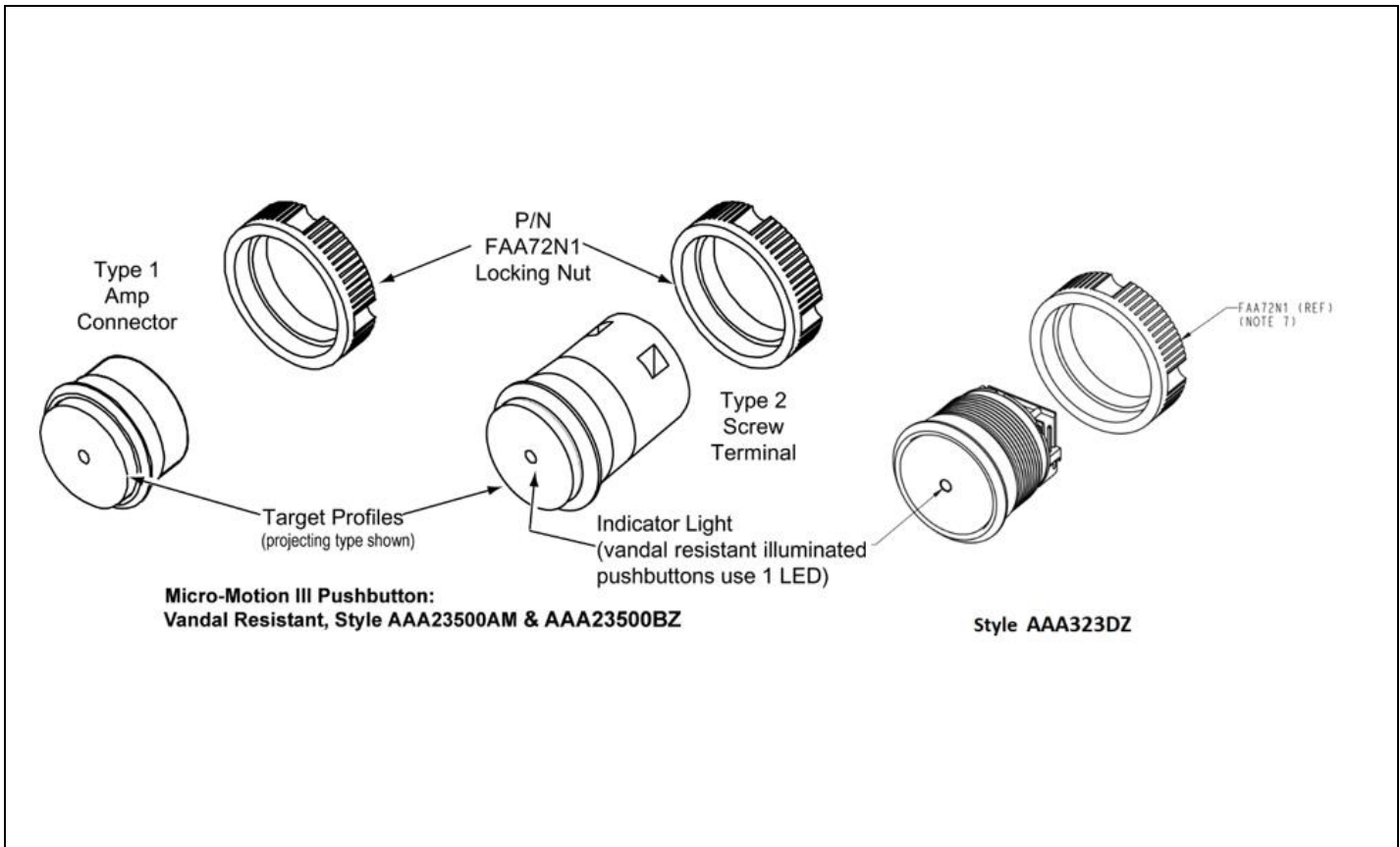

Part No.	Indicator Light Color	Overall Length	Voltage Rating	Style	No. of Contacts	Connector	Finish
AAA23500AM51	Non-Illuminating	19 mm	24 VDC	Concave Projecting 	N/A	Amp	BR7
AAA23500AM50	Red	19 mm	24 VDC		N/A	Amp	
AAA23500BZ57 AAA323DZ43141*	Red	28.4 mm	6 VDC		2	AMP	
AAA23500BZ58 AAA323DZ43141*					2	AMP	
AAA23500BZ59 AAA323DZ43241*	Red	28.4 mm	12 VDC		2	AMP	
AAA23500BZ60 AAA323DZ43241*					2	AMP	
AAA23500BZ64 AAA323DZ43512	Amber	33 mm	120 VAC		1	Screw	
AAA23500BZ62 AAA323DZ43512	Amber	33 mm	120 VDC		1		
AAA23500BZ63 AAA323DZ43527	Non-Illuminating	33 mm	120 V Max		2		

*NOTE: AAA174YL23 cable required with AAA323DZ button replacement.

Buttons for Non-Otis Controllers

32-AAA23500AM

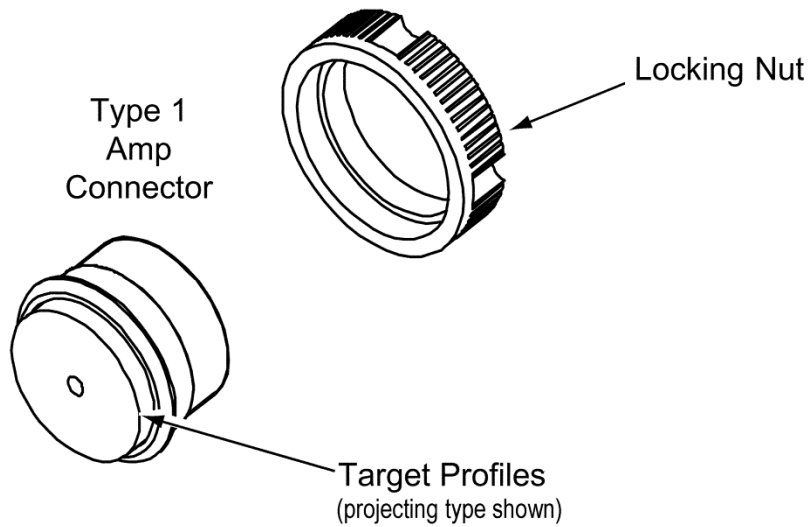

NOTE: All buttons for non-Otis controllers are 24 VDC, 4-wire configuration, amp connector.

Part No.	Indicator Light Color	Style	Finish	Overall Length
AAA23500AM452	Blue	Flat Flush	Brushed Bronze	19 mm
AAA23500AM455	Green			
AAA23500AM444	Red			
AAA23500AM459	White			
AAA23500AM439	Blue	Flat Flush	Stainless Steel	
AAA23500AM442	Green			
AAA23500AM401	Red			
AAA23500AM457	White			
AAA23500AM453	Blue	Flat Projecting	Brushed Bronze	
AAA23500AM456	Green			
AAA23500AM445	Red			
AAA23500AM460	White			
AAA23500AM440	Blue	Flat Projecting	Stainless Steel	
AAA23500AM443	Green			
AAA23500AM402	Red			
AAA23500AM458	White			
AAA23500AM454	Blue	Concave Flush	Brushed Bronze	
AAA23500AM446	Red			
AAA23500AM441	Blue	Concave Flush	Stainless Steel	
AAA23500AM403	Red			
AAA23500AM450	Red	Concave Projecting	Brushed Bronze	
AAA23500AM419	Red	Concave Projecting	Stainless Steel	