

**Keyswitch
Series 5**

Spare Parts Leaflet

32-AAA23851A

June 14, 2023 / Page 1 of 31

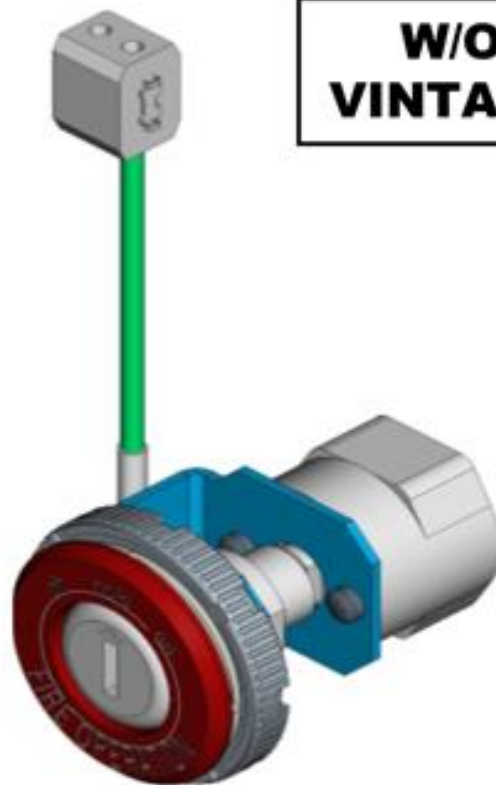

**W/O
VINTAGE**

OTIS

This document does not contain any technical data subject to EAR or ITAR

**SERVICE ENGINEERING
Otis Elevator Company
Bloomfield, Connecticut USA**

Unpublished Work—© Otis Elevator Co.; 2023

Leaflet Description

This fixture applies to the hydraulic and traction product fixtures.

Leaflet Revisions

Date Revised	Subject Matter Expert	Reason for Revision
August 10, 2004	Lisa K. Mitchell	New SPL initial release
September 20, 2005	Joseph Zych	Add new parts. Superseded parts.
November 11, 2005	Joseph Zych	Add Keyswitch assembly parts.
January 2, 2007	Michael Bertini	Added Attendant Service Keyswitches, p. 5; missing p/n AAA23851A57, 58, p. 8; Floor Lockout Housing, p. 20.
March 6, 2007	Michael Bertini	Per 2006 code requirements added Keyswitch arrangements AAA23851A128 through 136; Added housing arrangements AAA396PJ136 through 142
January 15, 2008	Michael Bertini	Addition of 2006 Florida fire code Keyswitches.
November 13, 2008	Joseph D. Zych	Corrected p/n and description errors throughout
December 7, 2009	Joseph D. Zych	Corrected Dim 'A' p. 14 p/n AAA396PJ16, 17, and 18.
January 11, 2010	Michael Bertini	p.4 added part 6599F6
February 10, 2010	Joseph D. Zych	Added AAA23851A173 and parts pp 10, 12, 21
May 26, 2010	Joseph D. Zych	Added parts AAA396PJ144–151 pp 16, 22
February 23, 2011	Joseph D. Zych	Moved division line for AAA396PJ16 (p. Error! Bookmark not defined.) to red color.
June 22, 2011	Joseph D. Zych	Added new arr. AAA23851A174–176 and AAA396PJ52 to pp 6, 15, 18, and 23
June 29, 2011	Joseph D. Zych	Correct hyperlinks on p. 5
December 21, 2011	Joseph D. Zych	Inserted new arrangements AAA23851A177–203 on pp. 13–14; added AAA396PJ154–155 on pp. 19 and 25
May 2, 2012	Joseph D. Zych	Corrected pp. 6 and 7
November 21, 2012	Joseph D. Zych	Updated function specifications for p/n AAA23851A28 on p. 8
November 6, 2013	Joseph D. Zych	Added AAA23851A206 and AAA396PJ158.
February 26, 2014	Joseph D. Zych	Corrected housing part numbers on p. 6
April 9, 2014	Joseph D. Zych	Corrected information for p/n AAA23851A92 on p. 12; Added the newest Keyswitches AAA23851A204 through AAA23851A207; Added new housings AAA396PJ156 through AAA396PJ158 on p. 25
July 16, 2014	Joseph D. Zych	Corrected description for p/n AAA23851A177
October 1, 2014	Joseph D. Zych	Added new Keyswitch arrangements AAA23851A208 through 211; Added new Keyswitch housing arrangements AAA396PJ188 and 189
January 14, 2015	Joseph D. Zych	Added Keyswitch Labels on pp. 15–17
June 24, 2015	Joseph D. Zych	Added Keyswitch Labels on pp. 18–19

Continued next page

History (continued)

32-AAA23851A

March 30, 2016	Scott C. Phillippi and Joseph Zych	<ul style="list-style-type: none">Removed obsolete AAA316GUA arrangements and added additional arrangements and diameter specifications on p. 4Corrected key type for arrangement A174 on p. 6Corrected collar specification from AAA396PJ154 to PJ193 and PJ155 to PJ194 on arrangements AAA23851A184-201 on pp. 13–14Added arrangement AAA23851A212 and graphic for Type 8 on p. 14Replaced collars PJ154 and PJ155 with PJ193 and PJ194 on p. 24Added new collars PJ193 and PJ194Crossed out obsolete collars PJ154 and PJ155 on p. 30
May 4, 2016	Joseph D. Zych	Corrected description for p/n AAA396PJ71
May 11, 2016	Joseph D. Zych	Removed p/n AAA23851A207 on p. 10
June 22, 2016	Scott C. Phillippi	Added 400 series kits; Updated page 4
June 14, 2017	Joseph Zych	Added elevator emergency power key switches for Arizona, Louisiana, and Virginia
July 12, 2017	Joseph Zych	Added housings AAA396PJ159 through 168
January 10, 2018	Joseph D. Zych	Corrected accents on French markings
May 2, 2018	Ramone Reynolds	Corrected descriptions for AAA23851A178–179, 182–183, and 218–222; added AAA23851A223–A227; Corrected alphabetical listing of key switches.
October 16, 2019	Charles Lowd	Added p/ns AAA23851A228–297 and AAA39PJ199–231
June 17, 2020	Joseph Zych	Corrected p/n AAA23851A131 on p. 9
March 10, 2021	Vadzim Fedarenka	Added Table of Contents, Keyswitch images; Removed housings;
May 5, 2021		Added SPLs on pp. 3, 5
January 12, 2022	Vadzim Fedarenka	Added p/ns AAA23851A304–309 on pp. 8, 13–16
June 14, 2023	Vadzim Fedarenka	Updated image for p/n AAA23851A11 on p.16

Related Drawings

Drawing No.	Title
AAA23851A	Hall Option Assembly, Landing Fixture, Keyswitch

Related Documents

Document ID	Title
SPL 31-AAA431AK	Lock Assembly
SPL 31-AAA431AF	Keylock
SPL 31-6410W	Advanced Fixture – Part 6410W Keyswitch Assembly
SPL 31-AAA396PJ	Keyswitch Housings
SPL 31-AAA634C	Lock Assembly
SPL 31-AAA636A	Fixture Part – Keyswitch, Rotary Switch
SPL 31-AAA25000DM	Car Operating Panel, Series 5 w/NEL Buttons
SPL 31-AAA25000DR	Car Operating Panel, Series 2 Fixtures
TIP 4.0-39	Keyswitch Resurface Labeling
TIP 0.1.6-11	Series 2 and 6 Keyswitch and Jewel Installation Tool (p/n MT-106006-4)

Subject Matter Expert

Name	Department
Vadzim Fedarenka	OSC Service Engineering

PAGE	DESCRIPTION
5	Keyswitch Assembly Types and Replacement Parts
6	Keypswitches by Function
6	Access (COP / HALL / JAMB)
6	Attendant Service (COP)
7	Car to Lobby (LOBBY)
7	COP Lockout (COP)
7	Earthquake Hoist Way Scan (HALL / LOBBY)
8	Elevator Communication Failure (HALL)
8	Elevator Emergency Power (HALL / LOBBY)
10	Elevator Emergency Power, as specified ** (HALL / LOBBY)
12	Fan (COP)
13	Fire Operation, SES Phase II (COP)
15	Fire Recall, Remote, SES Phase I (HALL / LOBBY)
16	Fire Recall, SES Phase I (HALL / LOBBY)
17	Fireman's Phone Jack (COP / HOB)
17	Floor Lockout (COP)
17	Group Security (HALL / LOBBY)
18	Hall Button Cutout (HALL)
18	Hall Call Registration (HALL)
18	HAD (Hoistway Access Detection) Reset (HALL)
19	In-Car Stop (COP)
19	Independent Service (COP)
19	Inspection (COP)
20	Key Call (HALL)
20	Light (COP)
20	MAD Touch Screen Reset (COP) – no image
21	Medical Emergency (COP / HOB)
22	OEO only, Fire Recall, Remote, SES Phase I (GROUP) (HALL / LOBBY)
23	OEO only, Fire Recall, SES Phase I (HALL)
24	OEO only, Fire Recall, SES Phase I (CAR XX) ** (HALL)
25	OEO only, Fire Recall, SES Phase I (GROUP or BANK [NYC]) (HALL)
26	Power (LOBBY)
26	Priority Service (HALL)
26	Secure Access (COP)
27	Keyswitch Label: Signage

Keyswitch Assembly Types and Replacement Parts

32-AAA23851A

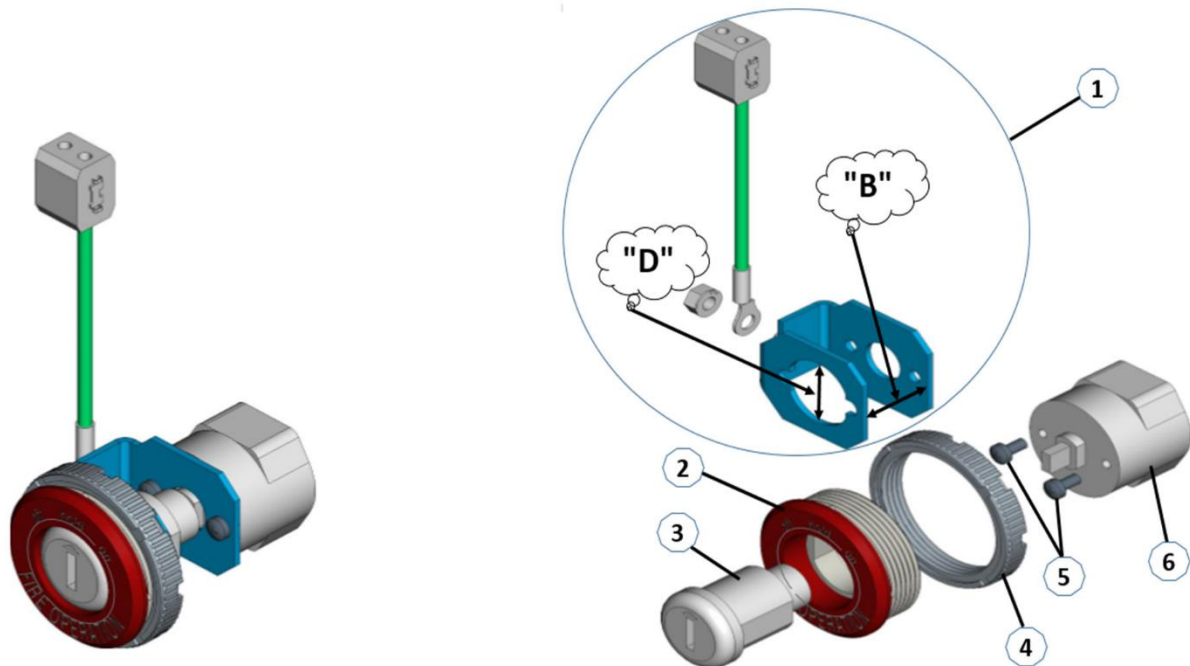
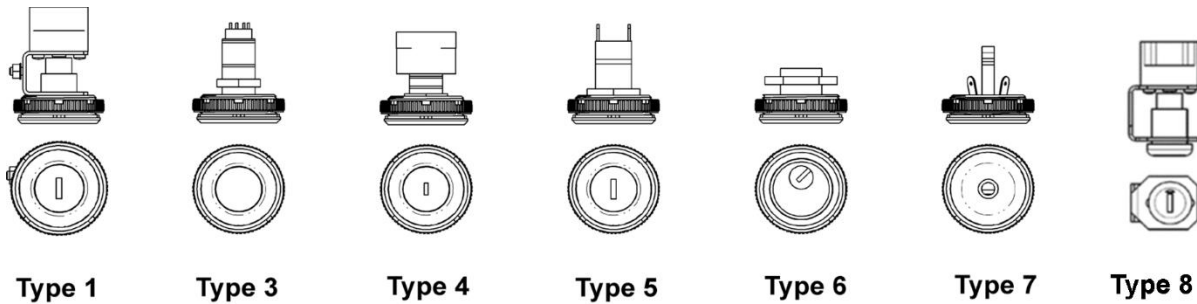

W/O VINTAGE		
REF. No.	PART No.	DESCRIPTION
1	AAA23851A401	Kit, Bracket: B = 18.9 mm, D = 19.3 mm, Round w/ Two Flats, w/ ground
	AAA23851A402	Kit, Bracket: B = 24.7 mm, D = 22.4 mm, Round w/ Two Flats, w/ ground
	AAA23851A403	Kit, Bracket: B = 16.8 mm, D = 18 mm, Round w/ Single Flat, w/ ground
	AAA23851A404	Kit, Bracket: "L" Bracket for Ground Only
	AAA23851A406	Kit, Bracket: B = 18.9 mm, D = 22.4 mm, Round w/ Two Flats, w/ ground
	AAA23851A407	Kit, Bracket: B = 24.7 mm, D = 19.3 mm, Round w/ Two Flats, w/ ground
2	---	Housing, Key Switch (see SPL 31-AAA396PJ)
3	---	Lock, Key (see SPL 31-AAA431AF, SPL 31-AAA431AK, SPL 31-AAA634C, SPL 31-6410W, and SPL 31-6599F)
4	AAA72JZ1	Nut, Plastic
5	ISO7045M3X6H-4.8Z	Screw, Pan Head, (2) M3 x 6 mm
6	---	Switch, Rotary (see SPL 31-AAA636A)

32-AAA23851A

Keyswitches by Function

Access (COP / HALL / JAMB)

Access Switches for COP

AAA23851A105

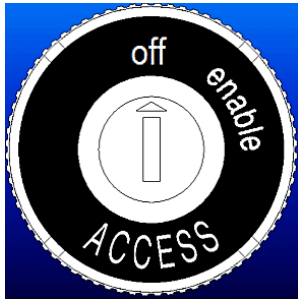

AAA23851A106



Access Switches for Hall / Jamb

AAA23851A175



AAA23851A176



AAA23851A208



AAA23851A209



Part No	Assy Type	Code Year	State / City	Language	Key	Lock Part No*	Bracket Kit Part No*	Switch Part No*
AAA23851A105	1	---	USA & CANADA	English	UTH	AAA431AF26	AAA23851A401	ABA636A5
AAA23851A106		---		French				ABA636A2
AAA23851A175		Pre-2013		English		AAA431AF27		ABA636A2
AAA23851A176		Pre-2013		French				
AAA23851A208		2013		English				
AAA23851A209		2013		French				

* Part numbers for reference

Attendant Service (COP)

AAA23851A57

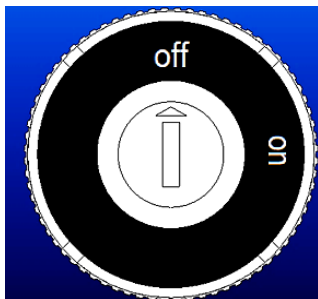

AAA23851A58



Part No	Assy Type	Code Year	State / City	Language	Key	Lock Part No*	Bracket Kit Part No*	Switch Part No*
AAA23851A57	5	---	USA & CANADA	English	UTC	6410W10	AAA23851A404	---
AAA23851A58				French				

* Part numbers for reference

Keyswitches by Function

32-AAA23851A

Car to Lobby (LOBBY)

AAA23851A63



AAA23851A64



Part No	Assy Type	Code Year	State / City	Language	Key	Lock Part No*	Bracket Kit Part No*	Switch Part No*
AAA23851A63	1	---	USA & CANADA	English	UTA	AAA431AF4	AAA23851A401	ABA636A11
AAA23851A64				French				

* Part numbers for reference

COP Lockout (COP)

AAA23851A206



Part No	Assy Type	Code Year	State / City	Language	Key	Lock Part No*	Bracket Kit Part No*	Switch Part No*
AAA23851A206	1	---	USA & CANADA	English	UTC	AAA431AF23	AAA23851A401	ABA636A9

* Part numbers for reference

Earthquake Hoistway Scan (HALL / LOBBY)

AAA23851A277



AAA23851A279 (CA)



Part No	Assy Type	Code Year	State / City	Language	Key	Lock Part No*	Bracket Kit Part No*	Switch Part No*
AAA23851A277	1	2016	USA & CANADA	English	UTH	AAA431AF27	AAA23851A401	ABA636A3
AAA23851A279			CA					

* Part numbers for reference

32-AAA23851A

Keyswitches by Function

Elevator Communication Failure (HALL)

AAA23851A304



AAA23851A305



Part No	Assy Type	Code Year	State / City	Language	Key	Lock Part No*	Bracket Kit Part No*	Switch Part No*
AAA23851A174**	1	2008	USA & CANADA	---	UTB	AAA431AF20	AAA23851A401	ABA636A3
AAA23851A304	1	2008	USA & CANADA	English	UTB	AAA431AF20	AAA23851A401	ABA636A3
AAA23851A305	1	2008	USA & CANADA	French	UTB	AAA431AF20	AAA23851A401	ABA636A3

* Part numbers for reference

** No image, BLANK Black

Elevator Emergency Power (HALL / LOBBY)

- AAA23851A33
- AAA23851A178
- AAA23851A182
- AAA23851A216



- AAA23851A45
- AAA23851A202

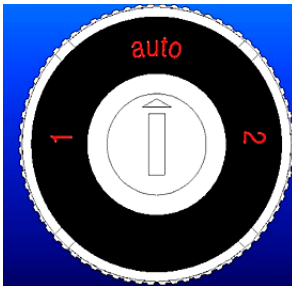

- AAA23851A35
- AAA23851A180



- AAA23851A47

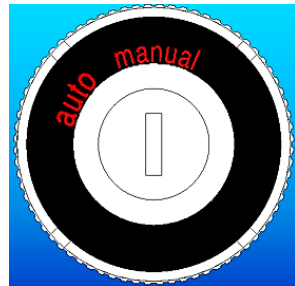

- AAA23851A37
- AAA23851A41
- AAA23851A43
- AAA23851A184
- AAA23851A186



- AAA23851A136



- AAA23851A131
- AAA23851A39



- AAA23851A218
- AAA23851A223



- AAA23851A188
- AAA23851A190
- AAA23851A192
- AAA23851A194
- AAA23851A196
- AAA23851A198
- AAA23851A200



Keyswitches by Function

32-AAA23851A

Part No	Assy Type	Code Year	State / City	Language	Key	Lock Part No*	Bracket Kit Part No*	Switch Part No*	
AAA23851A33 AAA23851A178 AAA23851A35 AAA23851A180	1	2000	USA & CANADA	English	UTF	AAA431AF3	AAA23851A401	ABA636A8	
French									
AAA23851A37			CHICAGO	English	5957 (SA)	AAA431AK1	AAA23851A402	ABA636A8	
AAA23851A39					CT	BFD1	AAA00431AAF002	AAA23851A403	ABA636A8
AAA23851A44 AAA23851A186					MA, ME, NH	3502	AAA431AK15	AAA23851A406	ABA636A8
AAA23851A45						SC	SC1000	AAA634D1	AAA23851A404
AAA23851A47			1	pre 2004	NYC	2642	AAA431AK9	AAA23851A402	ABA636A5
AAA23851A131 AAA23851A136	1	2007	USA & CANADA	English	FEO-K1	AAA00431AAF005	AAA23851A403	ABA636A8	
AAA23851A159 AAA23851A188				French					
AAA23851A164 AAA23851A190			2004	FL, R.1	English	---	AAA431AK30	AAA23851A406	ABA636A8
AAA23851A163 AAA23851A192	FL, R.2								
AAA23851A165 AAA23851A194	FL, R.3								
AAA23851A167 AAA23851A196 AAA23851A169 AAA23851A198	1	2004	FL, R.4	English	---	AAA431AK39	AAA23851A406	ABA636A8	
AAA23851A171 AAA23851A200									FL, R.5
AAA23851A182									FL, R.6
AAA23851A184									FL, R.7
AAA23851A182	4	2000	RI	WD01	AAA431AF30	AAA23851A401	ABA636A8		
AAA23851A184	1	2004	NYC	2642	AAA431AK8	AAA23851A406	ABA636A8		
AAA23851A202	3	2000	SC	SC1000	AAA431AF31	AAA23851A401	ABA636A2 3		
AAA23851A216	1	2004	AZ	AZFS	AAA431AF32	AAA23851A401	ABA636A8		
AAA23851A218			LA	LA-UEK	AAA431AK60	AAA23851A406	ABA636A8		
AAA23851A223			VA	Not used for ASME A17.1/CSA B44 Codes					

* Part numbers for reference

32-AAA23851A

Keyswitches by Function

Elevator Emergency Power, as Specified (HALL / LOBBY)

AAA23851A34
 AAA23851A179
 AAA23851A183
 AAA23851A217



AAA23851A36
 AAA23851A181



AAA23851A38
 AAA23851A42
 AAA23851A43
 AAA23851A44



AAA23851A40
 AAA23851A132



AAA23851A46
 AAA23851A203

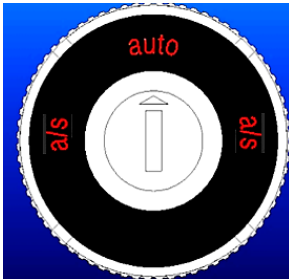

AAA23851A137



AAA23851A189
 AAA23851A191
 AAA23851A193
 AAA23851A195
 AAA23851A197
 AAA23851A199
 AAA23851A201



AAA23851A185
 AAA23851A187
 AAA23851A219
 AAA23851A224



Part No (NOTE 1)	Assy Type	Code Year	State / City	Language	Key	Lock Part No*	Bracket Kit Part No*	Switch Part No*		
AAA23851A34 AAA23851A179	1	2000	USA & CANADA	English	UTF	AAA431AF3	AAA23851A401	ABA636A8		
AAA23851A36 AAA23851A181				French						
AAA23851A38 AAA23851A40			CHICAGO CT	English	5957 (SA)	AAA431AK1	AAA23851A402	ABA636A8		
AAA23851A42 AAA23851A187					BFD1	AAA00431AAF002	AAA23851A403	ABA636A8		
AAA23851A43 AAA23851A187 AAA23851A44 AAA23851A187			4	Pre-2000	MA, ME, NH	English	3502	AAA431AK15	AAA23851A406	ABA636A8
AAA23851A46										
AAA23851A132 AAA23851A137			1	2007	USA & CANADA	English	FEO-K1	AAA00431AAF005	AAA23851A403	ABA636A8
AAA23851A160 AAA23851A189						French				
AAA23851A162 AAA23851A191				2004	FL, R.1	English	---	AAA431AK30	AAA23851A406	ABA636A8
AAA23851A164 AAA23851A193										
AAA23851A166 AAA23851A195	FL, R.3	AAA431AK36								
	FL, R.4	AAA431AK39								

Continued on next page

Keyswitches by Function

32-AAA23851A

Part No (NOTE 1)	Assy Type	Code Year	State / City	Language	Key	Lock Part No*	Bracket Kit Part No*	Switch Part No*
AAA23851A168 AAA23851A197	1	2004	FL, R.5	English	---	AAA431AK42	AAA23851A406	ABA636A8
AAA23851A170 AAA23851A199			FL, R.6			AAA431AK45		
AAA23851A172 AAA23851A201			FL, R.7			AAA431AK48		
AAA23851A183	4	2000	RI		WD01	AAA431AF30	AAA23851A401	ABA636A8
AAA23851A185	1	2004	NYC		2642	AAA431AK8	AAA23851A406	ABA636A8
AAA23851A203	3	2000	SC		SC1000	AAA431AF31	AAA23851A401	ABA636A23
AAA23851A217	1	2004	AZ		AZFS	AAA431AF32	AAA23851A401	ABA636A8
AAA23851A219			LA		LA-UEK	AAA431AK60	AAA23851A406	ABA636A8
AAA23851A224			VA		Not used for ASME A17.1/CSA B44 Codes			

* Part numbers for reference

NOTE 1: CAR IDENTIFICATION (a/s) should be specified by customer when ordering and will be engrave by machine shop per contract.

32-AAA23851A

Keyswitches by Function

Fan (COP)

AAA23851A48

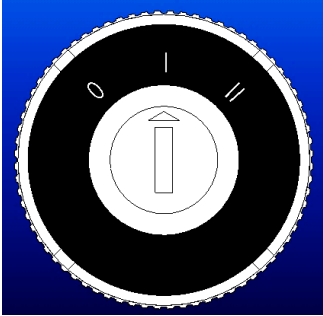

AAA23851A83

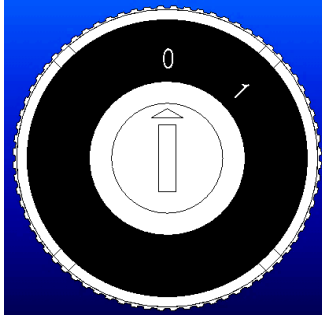

AAA23851A87

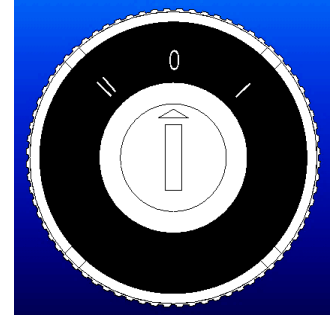

AAA23851A97



AAA23851A98

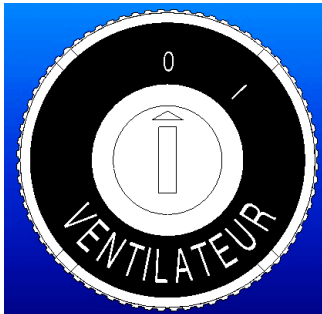

AAA23851A99

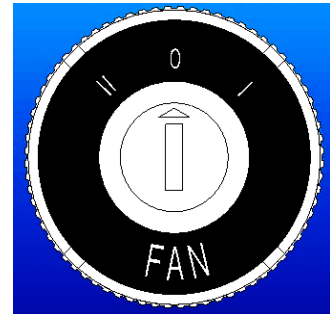

AAA23851A100



AAA23851A101



AAA23851A210

AAA23851A102



AAA23851A211

Part No	Assy Type	Code Year	State / City	Language	Key	Lock Part No*	Bracket Kit Part No*	Switch Part No*
AAA23851A48 (NOTE 2)	1	---	INTERNATIONAL	---	UTA	AAA431AF1	AAA23851A401	ABA636A12
AAA23851A83 (NOTE 1)				---				ABA636A10
AAA23851A87 (NOTE 2)				---				ABA636A4
AAA23851A97 (NOTE 1)				English				ABA636A10
AAA23851A98 (NOTE 1)				French				ABA636A10
AAA23851A99 (NOTE 2)				English				ABA636A4
AAA23851A100 (NOTE 2)				French				ABA636A4
AAA23851A101 (NOTE 3)				English				ABA636A12
AAA23851A102 (NOTE 3)				French				ABA636A12
AAA23851A210 (NOTE 3)				English				ABA636A25
AAA23851A211 (NOTE 3)				French				ABA636A25

* Part numbers for reference

NOTE 1: Single Speed Fan Switch, Discrete Hydro.

NOTE 2: Fan Switch, 2-Speeds.

NOTE 3: Fan Switch, 2-Speeds, GEN 2.

Keyswitches by Function

32-AAA23851A

Fire Operation, SES Phase II (COP)

AAA23851A23

AAA23851A115

AAA23851A214

AAA23851A309



AAA23851A24



AAA23851A25

AAA23851A116



AAA23851A26

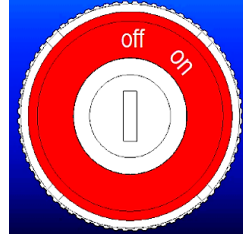

AAA23851A27

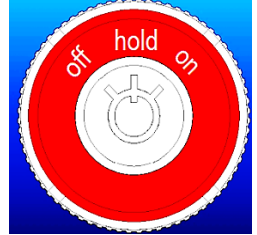

AAA23851A28

AAA23851A86

AAA23851A122

AAA23851A123

AAA23851A221

AAA23851A226



AAA23851A29

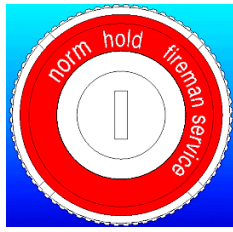

AAA23851A30

AAA23851A32

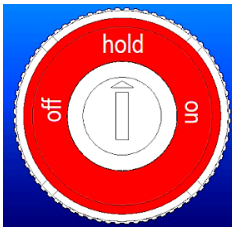

AAA23851A31

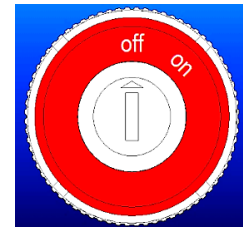

AAA23851A90

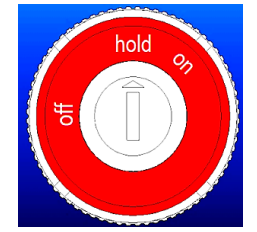

AAA23851A93

AAA23851A96

AAA23851A117

AAA23851A307

AAA23851A118

AAA23851A119

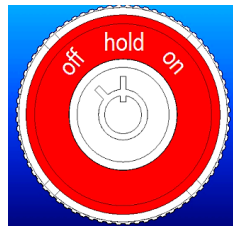
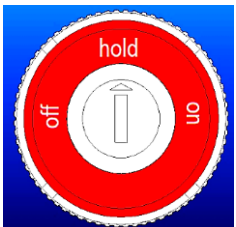

AAA23851A121

AAA23851A127

AAA23851A130

AAA23851A133

AAA23851A177



AAA23851A140

AAA23851A143

AAA23851A146

AAA23851A149

AAA23851A152

AAA23851A155

AAA23851A158



Continued on next page

32-AAA23851A

Keyswitches by Function

Part No	Assy Type	Code Year	State / City	Language	Key	Lock Part No*	Bracket Kit Part No*	Switch Part No*	
AAA23851A23 AAA23851A115	1	Pre-2000	USA & CANADA	English	UTF	AAA431AF17	AAA23851A401	ABA636A7	
AAA23851A24						AAA431AF3			
AAA23851A25 AAA23851A116						AAA431AF17			
AAA23851A26		2000	CHICAGO	French	5957 (SA)	AAA431AK2	AAA23851A402	ABA636A9	
AAA23851A27					BFD1	AAA00431AAF002	AAA23851A403	ABA636A7	
AAA23851A28 AAA23851A122		Pre-2000	MA	English	3502	AAA431AK15	AAA23851A402	ABA636A7	
AAA23851A29					2000	NYC	2642	AAA431AK9	AAA23851A402
AAA23851A30		3	Pre-2000	SC	English	SC1000	AAA634D2	AAA23851A404	---
AAA23851A31		1	2000	PA	English	UTF	AAA431AF7	AAA23851A401	ABA636A9
AAA23851A32		4	Pre-2000	RI	English	WD01	AAA634F2	AAA23851A404	---
AAA23851A86 AAA23851A123	1	2000	ME, NH	English	3502	AAA431AK16	AAA23851A402	ABA636A7	
AAA23851A90	3	Pre-2000	SC	English	SC1000	AAA634D4	AAA23851A404	---	
AAA23851A93	4		RI	English	WD01	AAA634F4	AAA23851A404	---	
AAA23851A96	2000		CT	English	BFD1	AAA00431AAF003	AAA23851A403	ABA636A7	
AAA23851A117	1	Pre-2000	USA & CANADA	English	UTF	AAA431AF3	AAA23851A401	ABA636A7	
AAA23851A118	4		RI	English	WD01	AAA634F2	AAA23851A404	---	
AAA23851A119	3	2000	SC	English	SC1000	AAA634D4	AAA23851A404	---	
AAA23851A121 AAA23851A127			CT	English	BFD1	AAA00431AAF003	AAA23851A403	ABA636A7	
AAA23851A122			MA	English	3502	AAA431AK15	AAA23851A402	ABA636A7	
AAA23851A124	1	Pre-2000	USA & CANADA / PA	English	UTF	AAA431AF7	AAA23851A401	ABA636A9	
AAA23851A130 AAA23851A133		2007	USA & CANADA	English French	FEO-K1	AAA00431AAF006	AAA23851A403	ABA636A7	
AAA23851A140 AAA23851A143 AAA23851A146 AAA23851A149 AAA23851A152 AAA23851A155 AAA23851A158		2004	FL R.1 FL R.2 FL R.3 FL R.4 FL R.5 FL R.6 FL R.7	English	---	AAA431AK32	AAA23851A402	ABA636A7	
AAA23851A177						AAA431AK35			
AAA23851A214						AAA431AK38			
AAA23851A221						AAA431AK41			
AAA23851A226						AAA431AK44			
AAA23851A307						AAA431AK47			
AAA23851A309						AAA431AK50			
AAA23851A214		Pre-2000	CT	English	BFD1	AAA00431AAF002	AAA23851A403	ABA636A7	
AAA23851A221	2004	AZ	English	AZFS	AAA431AF29	AAA23851A401	ABA636A7		
AAA23851A226		VA	English	LA-UEK	AAA431AK59	AAA23851A402	ABA636A7		
Not used for ASME A17.1/CSA B44 Codes									
AAA23851A307	4	Pre-2000	RI	English	WD01	AAA431AF34	AAA23851A404	ABA636A10	
AAA23851A309		2000				AAA431AF36		ABA636A7	

* Part numbers for reference

Keyswitches by Function

32-AAA23851A

Fire Recall, Remote SES Phase I (HALL / LOBBY)

AAA23851A14

AAA23851A215

AAA23851A308

AAA23851A15

AAA23851A16

AAA23851A17

AAA23851A19

AAA23851A95

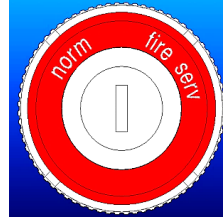

AAA23851A18

AAA23851A20

AAA23851A222

AAA23851A21

AAA23851A89

AAA23851A126

AAA23851A85

AAA23851A227

AAA23851A22

AAA23851A92

AAA23851A129

AAA23851A135



AAA23851A139

AAA23851A142

AAA23851A145

AAA23851A148

AAA23851A151

AAA23851A154

AAA23851A157



Part No	Assy Type	Code Year	State / City	Language	Key	Lock Part No*	Bracket Kit Part No*	Switch Part No*		
AAA23851A14	1	2000	USA & CANADA	English	UTF	AAA431AF9	AAA23851A401	ABA636A5		
AAA23851A15		Pre-2000		French						
AAA23851A16		2000		NYC						
AAA23851A17	3	Pre-2000	CHICAGO	English	2642	AAA431AK10	AAA23851A402	ABA636A9		
AAA23851A18			5957 (SA)		AAA431AK4	AAA23851A402	ABA636A9			
AAA23851A19			BFD1		AAA00431AAF001	AAA23851A403	ABA636A5			
AAA23851A20			3502		AAA431AK18	AAA23851A402	ABA636A5			
AAA23851A21			SC1000		AAA634D3	AAA23851A404	---			
AAA23851A22			4		RI	AAA23851A404	---			
AAA23851A85			1		MA, ME, NH	3502	AAA431AK18	AAA23851A402	ABA636A5	
AAA23851A89			3		SC	SC1000	AAA634D3	AAA23851A404	---	
AAA23851A92			4		RI	WD01	AAA634F3	AAA23851A404	---	
AAA23851A95			1		2000	CT	BFD1	AAA00431AAF001	AAA23851A403	ABA636A5
AAA23851A126	2007	USA & CANADA		English		FEO-K1	AAA00431AAF004	AAA23851A403	ABA636A5	
AAA23851A129				French						
AAA23851A139	2004	2004		FL R.1		English	---	AAA431AK31	AAA23851A402	ABA636A5
AAA23851A142				FL R.2						
AAA23851A145				FL R.3						
AAA23851A148				FL R.4						
AAA23851A151				FL R.5						
AAA23851A154				FL R.6						
AAA23851A157				FL R.7						
AAA23851A215	AZ	English	AZFS	AAA431AF28	AAA23851A401	ABA636A5				
AAA23851A222	LA	English	LA-UEK	AAA431AK58	AAA23851A402	ABA636A5				
AAA23851A227	VA	Not used for ASME A17.1/CSA B44 Codes								
AAA23851A308	4	2000	RI	English	WD01	AAA431AF35	AAA23851A404	ABA636A6		

* Part numbers for reference

32-AAA23851A

Keyswitches by Function

Fire Recall, SES Phase I (HALL / LOBBY)

AAA23851A6

AAA23851A213

AAA23851A306



AAA23851A7

AAA23851A12



AAA23851A8



AAA23851A9



AAA23851A10



AAA23851A84

AAA23851A220

AAA23851A225



AAA23851A94

AAA23851A125

AAA23851A128



AAA23851A13



AAA23851A88



AAA23851A91



AAA23851A134



AAA23851A138

AAA23851A141

AAA23851A144

AAA23851A147

AAA23851A150

AAA23851A153

AAA23851A156

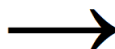

AAA23851A11



Part No	Assy Type	Code Year	State / City	Language	Key	Lock Part No*	Bracket Kit Part No*	Switch Part No*			
AAA23851A6	1	2000	USA & CANADA	English	UTF	AAA431AF9	AAA23851A401	ABA636A6			
AAA23851A7		Pre-2000		French							
AAA23851A8		2000		English							
AAA23851A9	3	Pre-2000	NYC	English	2642	AAA431AK11	AAA23851A402	ABA636A9			
AAA23851A10			CT		BFD1	AAA00431AAF001	AAA23851A403	ABA636A6			
AAA23851A11			MA, ME, NH		3502	AAA431AK18	AAA23851A402	ABA636A6			
AAA23851A12			SC		SC1000	AAA634D1	AAA23851A404	---			
AAA23851A13			RI		WD01	AAA634F1	AAA23851A404	---			
AAA23851A84			1		2000	MA, ME, NH	English	3502	AAA431AK18	AAA23851A402	ABA636A6
AAA23851A88			3			SC		SC1000	AAA634D1	AAA23851A404	---
AAA23851A91	4	RI	WD01	AAA634F1		AAA23851A404		---			
AAA23851A94	1	2007	USA & CANADA	English	FEO-K1	AAA00431AAF004	AAA23851A403	ABA636A6			
AAA23851A125				French							
AAA23851A128				English							
AAA23851A134	1	2004	FL R.1	English	---	AAA431AK31	AAA23851A402	ABA636A6			
AAA23851A138			FL R.2								
AAA23851A141			FL R.3								
AAA23851A144			FL R.4								
AAA23851A147			FL R.5								
AAA23851A150			FL R.6								
AAA23851A153			FL R.7								
AAA23851A156	4	2000	AZ	English	AZFS	AAA431AF28	AAA23851A401	ABA636A6			
AAA23851A213			LA	English	LA-UEK	AAA431AK58	AAA23851A402	ABA636A6			
AAA23851A220			VA	Not used for ASME A17.1/CSA B44 Codes							
AAA23851A225	4	2000	RI	English	WD01	AAA431AF33	AAA23851A404	ABA636A6			
AAA23851A306											

* Part numbers for reference

Keyswitches by Function

32-AAA23851A

Fireman's Phone Jack (COP / HOB)

AAA23851A80



AAA23851A81

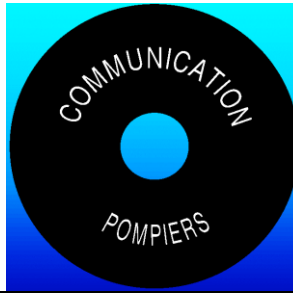

AAA23851A82

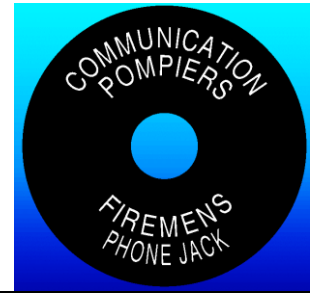

Part No	Assy Type	Code Year	State / City	Language	Key	Lock Part No*	Bracket Kit Part No*	Switch Part No*
AAA23851A80	7	---	USA & CANADA	English	---	6599F5	---	---
AAA23851A81				French				
AAA23851A82				Bilingual				

* Part numbers for reference

Floor Lockout (COP)

AAA23851A72

AAA23851A113

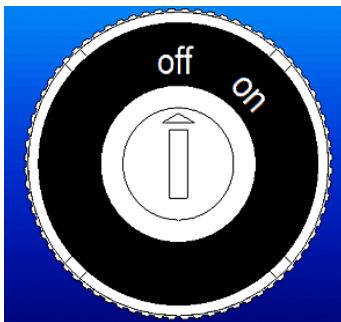

AAA23851A73



Part No	Assy Type	Code Year	State / City	Language	Key	Lock Part No*	Bracket Kit Part No*	Switch Part No*
AAA23851A72	1	---	USA & CANADA	English	UTC	AAA431AF8	AAA23851A401	ABA636A5
AAA23851A73				French				
AAA23851A113				English		AAA431AF23		

* Part numbers for reference

Group Security (HALL / LOBBY)

AAA23851A61



AAA23851A62



Part No	Assy Type	Code Year	State / City	Language	Key	Lock Part No*	Bracket Kit Part No*	Switch Part No*
AAA23851A61	5	---	USA & CANADA	English	UTG	6410W20	AAA23851A404	---
AAA23851A62	5	---		French				

* Part numbers for reference

32-AAA23851A

Keyswitches by Function

Hall Button Cutout (HALL)

AAA23851A69
AAA23851A207

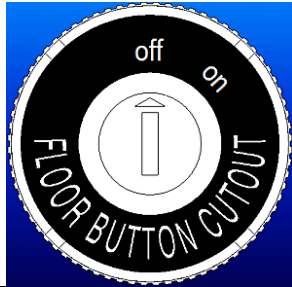

AAA23851A70



Part No	Assy Type	Code Year	State / City	Language	Key	Lock Part No*	Bracket Kit Part No*	Switch Part No*
AAA23851A69 AAA23851A207 AAA23851A70	1	---	USA & CANADA	English French	UTC	AAA431AF23	AAA23851A401	ABA636A9

*- Part Numbers for reference

Hall Call Registration (HALL)

AAA23851A65

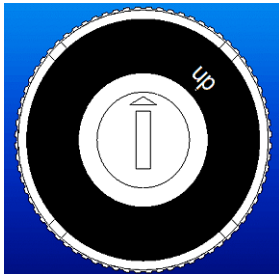

AAA23851A66



AAA23851A67

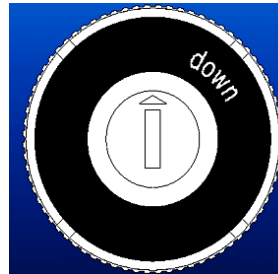

AAA23851A68

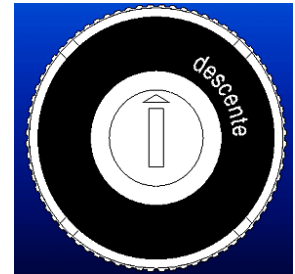

Part No	Assy Type	Code Year	State / City	Language	Key	Lock Part No*	Bracket Kit Part No*	Switch Part No*
AAA23851A65 (NOTE 1) AAA23851A66 (NOTE 1) AAA23851A67 (NOTE 2) AAA23851A68 (NOTE 2)	1	---	USA & CANADA	English French English French	UTA	AAA431AF4	AAA23851A401	ABA636A3

* Part numbers for reference

NOTE 1: UP Hall Call Registration Keyswitch

NOTE 2: DOWN Hall Call Registration Keyswitch

HAD (Hoistway Access Detection) Reset (HALL)

AAA23851A204

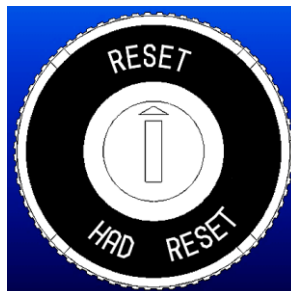

Part No	Assy Type	Code Year	State / City	Language	Key	Lock Part No*	Bracket Kit Part No*	Switch Part No*
AAA23851A204	1	---	USA & CANADA	English	UTH	AAA431AF27	AAA23851A401	ABA636A3

* Part numbers for reference

Keyswitches by Function

32-AAA23851A

In-Car Stop (COP)

AAA23851A3
AAA23851A79 (CA)

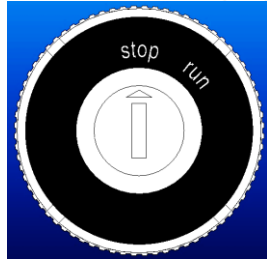

AAA23851A4



Part No	Assy Type	Code Year	State / City	Language	Key	Lock Part No*	Bracket Kit Part No*	Switch Part No*
AAA23851A3	1	2000	USA & CANADA	English	UTE	AAA431AF18	AAA23851A401	ABA636A10
AAA23851A4				French				
AAA23851A79			CA	English	UTA	AAA431AF1		

* Part numbers for reference

Independent Service (COP)

AAA23851A49

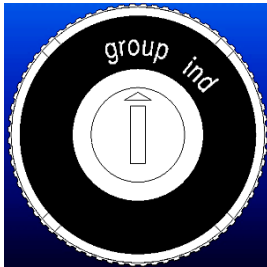

AAA23851A50



AAA23851A107

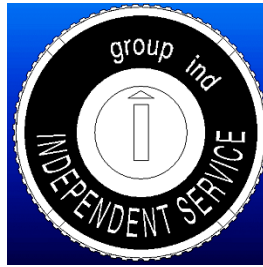

AAA23851A108



Part No	Assy Type	Code Year	State / City	Language	Key	Lock Part No*	Bracket Kit Part No*	Switch Part No*
AAA23851A49	1	---	USA & CANADA	English	UTA	AAA431AF1	AAA23851A401	ABA636A5
AAA23851A50				French				
AAA23851A107				English				
AAA23851A108				French				

* Part numbers for reference

Inspection (COP)

AAA23851A1

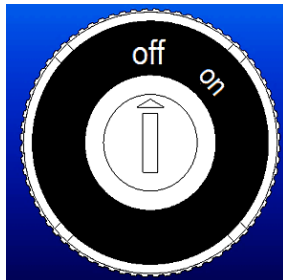

AAA23851A2



AAA23851A173



Part No	Assy Type	Code Year	State / City	Language	Key	Lock Part No*	Bracket Kit Part No*	Switch Part No*
AAA23851A1	1	Pre-2000	USA & CANADA	English	UTH	AAA431AF26	AAA23851A401	ABA636A5
AAA23851A2				French				
AAA23851A173		2000		English				

* Part numbers for reference

32-AAA23851A

Keyswitches by Function

Key Call (HALL)

AAA23851A205

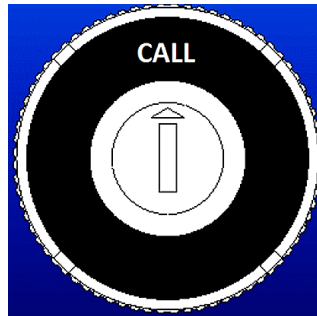

Part No	Assy Type	Code Year	State / City	Language	Key	Lock Part No*	Bracket Kit Part No*	Switch Part No*
AAA23851A205	1	---	USA & CANADA	English	UTA	AAA431AF19	AAA23851A401	ABA636A3

* Part numbers for reference

Light (COP)

AAA23851A5

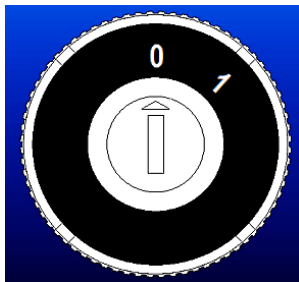

AAA23851A103

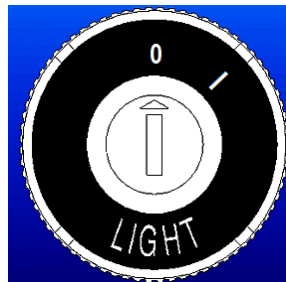

AAA23851A104

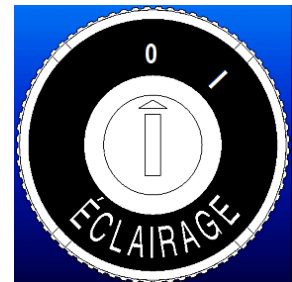

Part No	Assy Type	Code Year	State / City	Language	Key	Lock Part No*	Bracket Kit Part No*	Switch Part No*
AAA23851A5	1	---	USA & CANADA	---	UTB	AAA431AF24	AAA23851A401	ABA636A10
AAA23851A103				English				
AAA23851A104				French				

* Part numbers for reference

MAD Touch Screen Reset (COP), No Housing Provided

Part No	Assy Type	Code Year	State / City	Language	Key	Lock Part No*	Bracket Kit Part No*	Switch Part No*
AAA23851A212	8	---	USA & CANADA	---	UTB	AAA431AF20	AAA23851A407	ABA636A1

* Part numbers for reference

Keyswitches by Function

32-AAA23851A

Medical Emergency (COP / HOB)

AAA23851A51

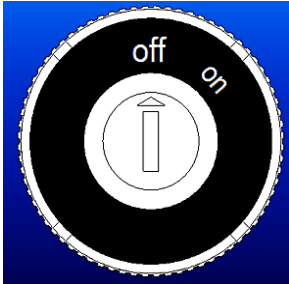

AAA23851A52



AAA23851A109



AAA23851A110



AAA23851A55**



AAA23851A56***



AAA23851A114**



Part No	Assy Type	Code Year	State / City	Language	Key	Lock Part No*	Bracket Kit Part No*	Switch Part No*
AAA23851A51	1	---	USA & CANADA	English	UTD	AAA431AF2	AAA23851A401	ABA636A5
AAA23851A52				French				
AAA23851A55 (Note 1)	3		MA	English	---	AAA634C2	AAA23851A404	---
AAA23851A56 (Note 2)								
AAA23851A109	1		USA & CANADA	English	UTD	AAA431AF2	AAA23851A401	ABA636A5
AAA23851A110				French				
AAA23851A114 (Note 1)	3		MA	English	---	AAA634C2	AAA23851A404	---

* Part numbers for reference

NOTE 1: COP Location.

NOTE 2: Hall Option Box Location.

32-AAA23851A

Keyswitches by Function

OEO only, Fire Recall, Remote, SES Phase I (HALL / LOBBY)

AAA23851A276
AAA23851A294



AAA23851A278
AAA23851A280



AAA23851A281
AAA23851A282



AAA23851A284
AAA23851A285
AAA23851A286



AAA23851A295
AAA23851A296



AAA23851A301



AAA23851A287
AAA23851A288
AAA23851A289
AAA23851A290
AAA23851A291
AAA23851A292
AAA23851A293



Part No	Assy Type	Code Year	State / City	Language	Key	Lock Part No*	Bracket Kit Part No*	Switch Part No*
AAA23851A276	1	2013	USA & CANADA	English	UTF	AAA431AF9	AAA23851A401	ABA636A5
AAA23851A278			CHICAGO		5957 (SA)	AAA431AK4	AAA23851A402	ABA636A9
AAA23851A280			MA, ME, NH		3502	AAA431AK18	AAA23851A402	ABA636A5
AAA23851A281	3		SC		SC1000	AAA634D3	AAA23851A404	---
AAA23851A282			RI		WD01	AAA634F3	AAA23851A404	---
AAA23851A284	4		CT		BFD1	AAA00431AAF001	AAA23851A403	ABA636A5
AAA23851A285								
AAA23851A286	1		USA & CANADA		FEO-K1	AAA00431AAF004	AAA23851A403	ABA636A5
AAA23851A287			FL R.1		---	AAA431AK31	AAA23851A402	ABA636A5
AAA23851A288			FL R.2			AAA431AK34		
AAA23851A289			FL R.3			AAA431AK37		
AAA23851A290			FL R.4			AAA431AK40		
AAA23851A291			FL R.5			AAA431AK43		
AAA23851A292			FL R.6			AAA431AK46		
AAA23851A293			FL R.7			AAA431AK49		
AAA23851A294		AZ	AZFS	AAA431AK28	AAA23851A401	ABA636A5		
AAA23851A295		LA	LA-UEK	AAA431AK58	AAA23851A402	ABA636A5		
AAA23851A296		VA	Not used for ASME A17.1/CSA B44 Codes					
AAA23851A301		NYC	English	2642	AAA431AK10	AAA23851A402	ABA636A9	

* Part numbers for reference

Keyswitches by Function

32-AAA23851A

OEO only, Fire Recall, SES Phase I (HALL)

AAA23851A228

AAA23851A229

AAA23951A245

AAA23851A230

AAA23851A231

AAA23851A232

AAA23851A236

AAA23851A233

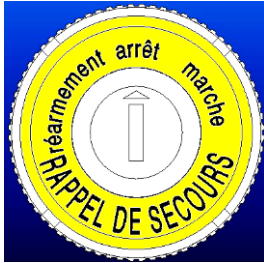

AAA23851A238

AAA23851A239

AAA23851A242

AAA23851A240

AAA23851A243

AAA23851A241

AAA23851A244

AAA23851A234

AAA23851A235

AAA23851A237



Part No	Assy Type	Code Year	State / City	Language	Key	Lock Part No*	Bracket Kit Part No*	Switch Part No*	
AAA23851A228	1	2013	USA & CANADA	out of production					
AAA23851A229				English	UTF	AAA431AF9	AAA23851A401	ABA636A6	
AAA23851A230			French						
AAA23851A231			NYC	English	2642	AAA431AK11	AAA23851A401	ABA636A9	
AAA23851A232	CT		BFD1		AAA00431AAF001	AAA23851A402	ABA636A6		
AAA23851A233	MA, ME, NH		3502		AAA431AK18	AAA23851A403	ABA636A6		
AAA23851A234	SC		SC1000		AAA634D1	AAA23851A402	--		
AAA23851A235	4		RI	WD01	AAA634F1	AAA23851A404	--		
AAA23851A236	1		USA & CANADA	English	FEO-K1	AAA00431AAF004	AAA23851A403	ABA636A6	
AAA23851A237			French						
AAA23851A238			FL R.1	English	---	AAA431AK31	AAA23851A402	ABA636A6	
AAA23851A239			FL R.2			AAA431AK34			
AAA23851A240		FL R.3	AAA431AK37						
AAA23851A241		FL R.4	AAA431AK40						
AAA23851A242		FL R.5	AAA431AK43						
AAA23851A243		FL R.6	AAA431AK47						
AAA23851A244		FL R.7	AAA431AK50						
AAA23851A245		AZ	English			AZFS			AAA431AF28

* Part numbers for reference

32-AAA23851A

Keyswitches by Function

OEO only, Fire Recall, SES Phase I (CAR XX) (HALL)

AAA23851A246
AAA23951A260



AAA23851A247
AAA23851A248



AAA23851A252



AAA23851A249



AAA23851A250



AAA23851A253

AAA23851A254

AAA23851A257

AAA23851A255

AAA23851A258

AAA23851A297

AAA23851A300

AAA23851A251



AAA23851A256

AAA23851A259



AAA23851A298

AAA23851A303



Part No (NOTE 1)	Assy Type	Code Year	State / City	Language	Key	Lock Part No*	Bracket Kit Part No*	Switch Part No*	
AAA23851A246	1	2013	USA & CANADA	English	UTF	AAA431AF9	AAA23851A401	ABA636A6	
AAA23851A247			NYC		2642	AAA431AK11	AAA23851A402	ABA636A9	
AAA23851A248			NYC	out of production					
AAA23851A249	3		MA, ME, NH	English	3502	AAA431AK18	AAA23851A402	ABA636A6	
AAA23851A250			SC		SC1000	AAA634D1	AAA23851A404	---	
AAA23851A251			RI		WD01	AAA634F1	AAA23851A404	---	
AAA23851A252	1		USA & CANADA	out of production					
AAA23851A253			FL R.1	English	---	AAA431AK31	AAA23851A402	ABA636A6	
AAA23851A254			FL R.2			AAA431AK34			
AAA23851A255			FL R.3			AAA431AK37			
AAA23851A256		FL R.4	AAA431AK40						
AAA23851A257		FL R.5	AAA431AK43						
AAA23851A258		FL R.6	AAA431AK47						
AAA23851A259		FL R.7	AAA431AK50						
AAA23851A260		AZ	AZFS	AAA431AF28	AAA23851A401	ABA636A8			
AAA23851A297		USA & CANADA	FEO-K1	AAA00431AAF004	AAA23851A403	ABA636A6			
AAA23851A298	CT	BFD1	AAA00431AAF001	AAA23851A403	ABA636A6				
AAA23851A300	LA	LA-UEK	AAA431AK58	AAA23851A402	ABA636A6				
AAA23851A303	VA	Not used for ASME A17.1/CSA B44 Codes							

* Part numbers for reference

NOTE 1: CAR IDENTIFICATION (XX) should be specified by customer when ordering and will be engrave by machine shop per contract.

Keyswitches by Function

32-AAA23851A

OEO only, Fire Recall, SES Phase I (GROUP or BANK [NYC]) (HALL)



Part No	Assy Type	Code Year	State / City	Language	Key	Lock Part No*	Bracket Kit Part No*	Switch Part No*
AAA23851A261	1	Pre-2000	USA & CANADA	English	UTF	AAA431AF9	AAA23851A401	ABA636A6
AAA23851A262		2013			FEO-K1	AAA00431AAF004	AAA23851A403	ABA636A6
AAA23851A263		Pre-2000	CT		UTF	AAA431AF9	AAA23851A401	ABA636A6
AAA23851A264					BFD1	AAA00431AAF001	AAA23851A403	ABA636A6
AAA23851A265		2013	AZ		AZFS	AAA431AF28	AAA23851A401	ABA636A8
AAA23851A266					---	AAA431AK31	AAA23851A402	ABA636A6
AAA23851A267						AAA431AK34		
AAA23851A268						AAA431AK37		
AAA23851A269						AAA431AK40		
AAA23851A270						AAA431AK43		
AAA23851A271						AAA431AK47		
AAA23851A272						AAA431AK49		
AAA23851A273						3502		
AAA23851A274					4	RI	WD01	AAA634F1
AAA23851A275		3	SC		SC1000	AAA634D1	AAA23851A404	---
AAA23851A283		1	NYC		2602	AAA431AK11	AAA23851A402	ABA636A9
AAA23851A299	LA		LA-UEK	AAA431AK58	AAA23851A402	ABA636A6		
AAA23851A302	VA		Not used for ASME A17.1/CSA B44 Codes					

* Part numbers for reference

Power (LOBBY)

AAA23851A71

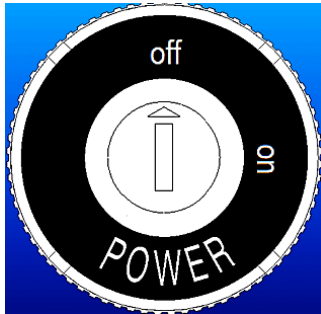

AAA23851A78



Part No	Assy Type	Code Year	State / City	Language	Key	Lock Part No*	Bracket Kit Part No*	Switch Part No*
AAA23851A71	5	---	USA & CANADA	English	UTA	6410W3	AAA23851A404	---
AAA23851A78				French				

* Part numbers for reference

Priority Service (HALL)

AAA23851A59



AAA23851A60



Part No	Assy Type	Code Year	State / City	Language	Key	Lock Part No*	Bracket Kit Part No*	Switch Part No*
AAA23851A59	1	---	USA & CANADA	English	UTD	AAA431AF22	AAA23851A401	ABA636A3
AAA23851A60				French				

* Part numbers for reference

Secure Access (COP)

AAA23851A53

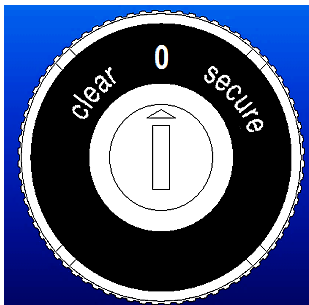

AAA23851A54

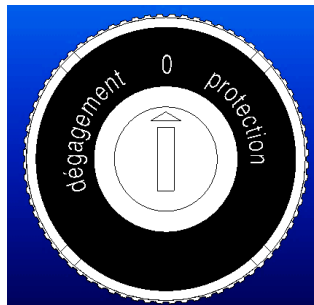

AAA23851A111



AAA23851A112

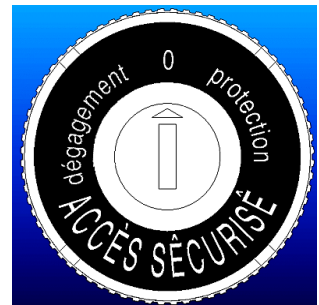

Part No	Assy Type	Code Year	State / City	Language	Key	Lock Part No*	Bracket Kit Part No*	Switch Part No*
AAA23851A53	1	---	USA & CANADA	English	UTG	AAA431AF25	AAA23851A401	ABA636A1
AAA23851A54				French				
AAA23851A111				English				
AAA23851A112				French				

* Part numbers for reference

Keyswitches by Function

32-AAA23851A

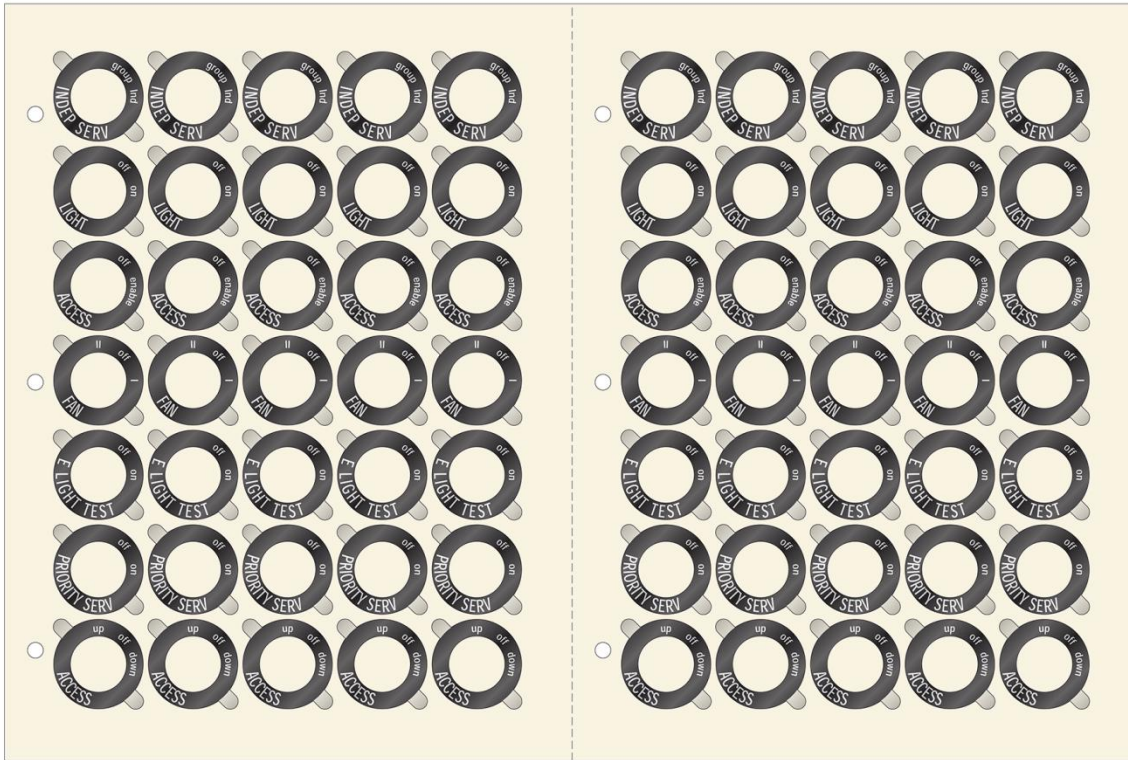

1

W/O VINTAGE		
REF. No.	PART No.	DESCRIPTION
1	AAA102AYK1	Label, Keyswitch Housing (black with white lettering) Label Sheet Includes Labels: INDEP SERV, LIGHT, ACCESS ENABLE, FAN 2 SPEED, E LIGHT TEST, PRIORITY SERV, and HALL ACCESS (10 pcs. each)

NOTE: When AAA396PJ housing doesn't have marking, use keyswitch labels for special types of housing only. See TIP 4.0-39, *Keyswitch Resurface Labeling*.

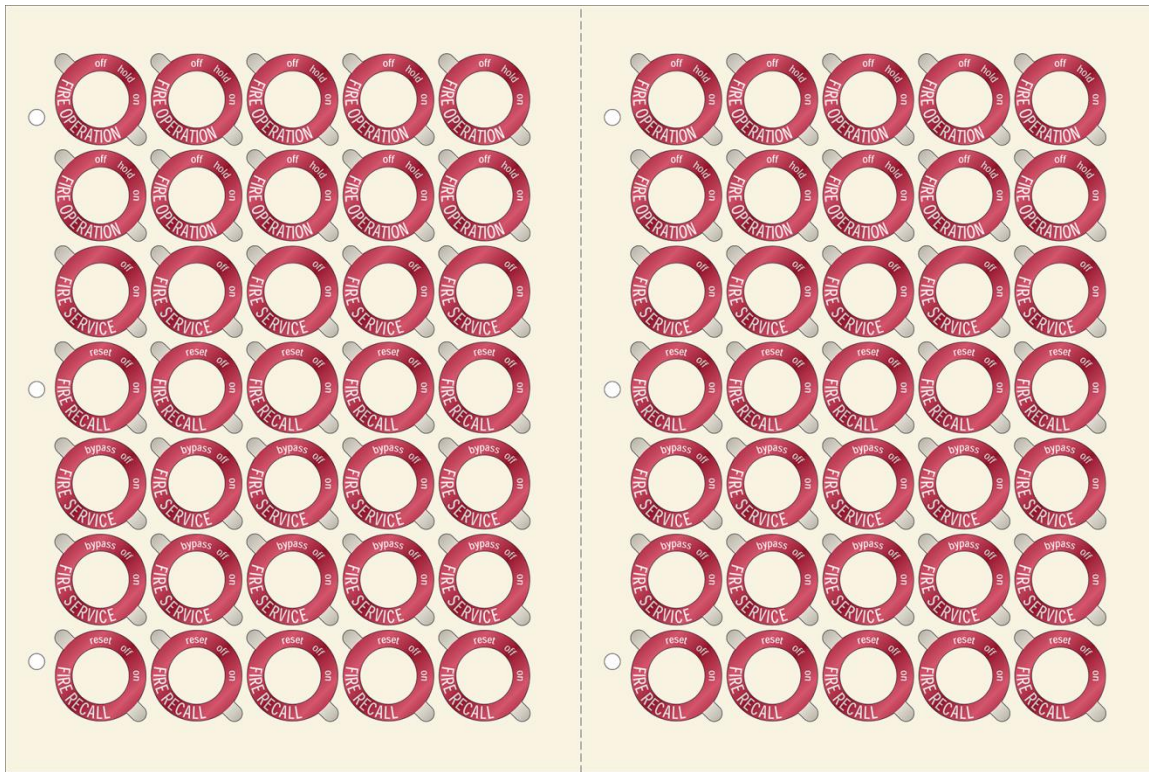

1

W/O VINTAGE		
REF. No.	PART No.	DESCRIPTION
1	AAA102AYK2	Label, Keyswitch Housing (red with white lettering) Label Sheet Includes Labels PRE & POST 2000 CODE: FIRE OPERATION (20 pcs.), FIRE SERVICE (20 pcs.), FIRE RECALL (20 pcs.), FIRE SERVICE (REMOTE) (10 pcs.) for both car and hall.

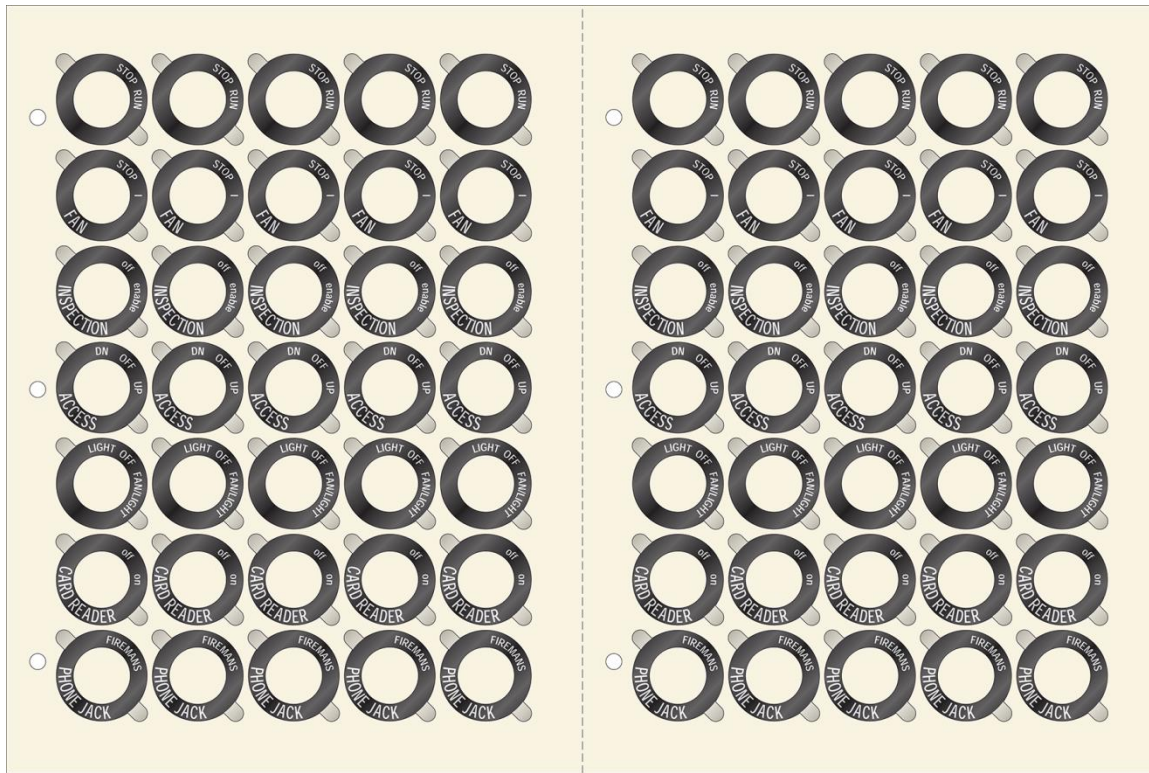

1

W/O VINTAGE		
REF. No.	PART No.	DESCRIPTION
1	AAA102AYK3	Label, Keyswitch Housing (black with white lettering) Label Sheet Includes Labels: RUN /STOP 1, SPEED FAN, INSPECTION ENABLE, ACCESS (DN-OFF-UP), LIGHT FAN COMBO, CARD READER, and FIREMANS PHONE JACK (10 pcs. each)

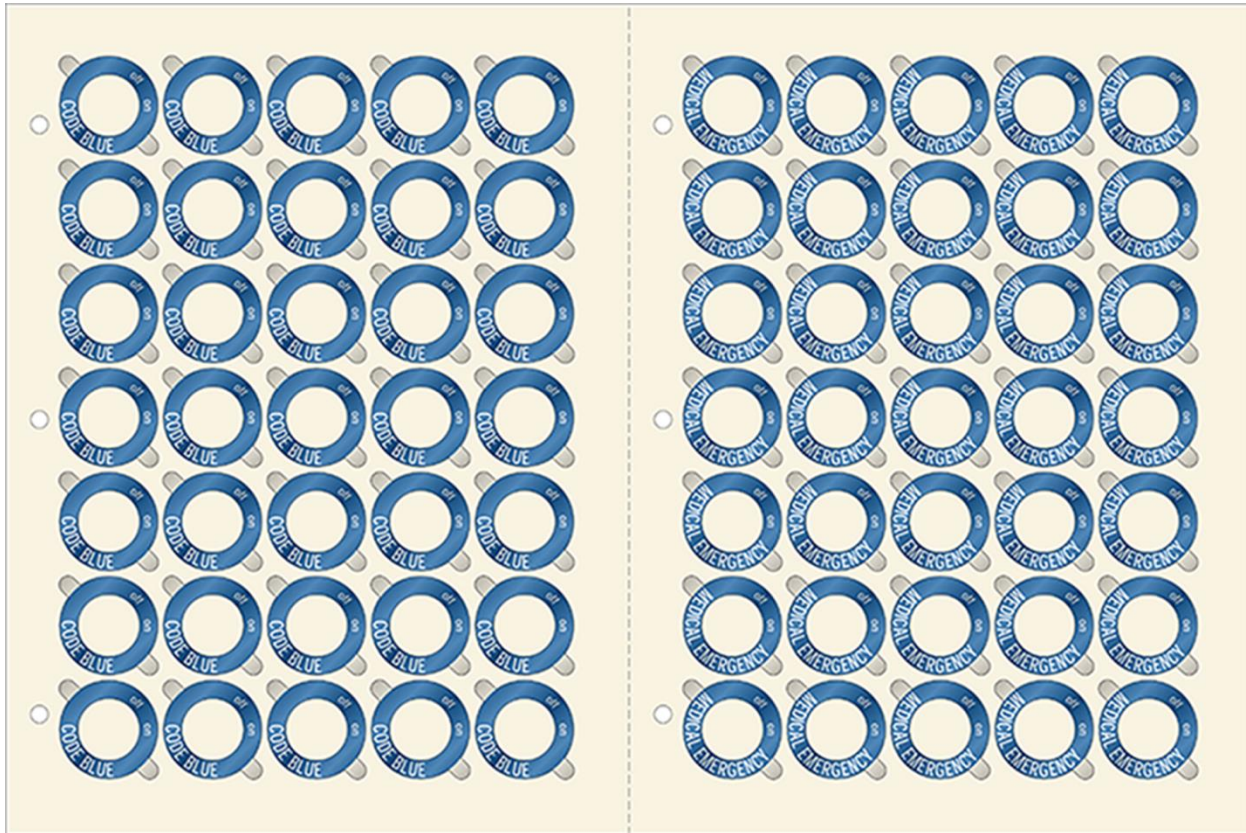

1

REF. No.	W/O VINTAGE PART No.	DESCRIPTION
1	AAA102AYK4	Label, Keyswitch Housing (blue with white lettering) Label Sheet Includes Labels: CODE BLUE and MEDICAL EMERGENCY (70 pcs. each).

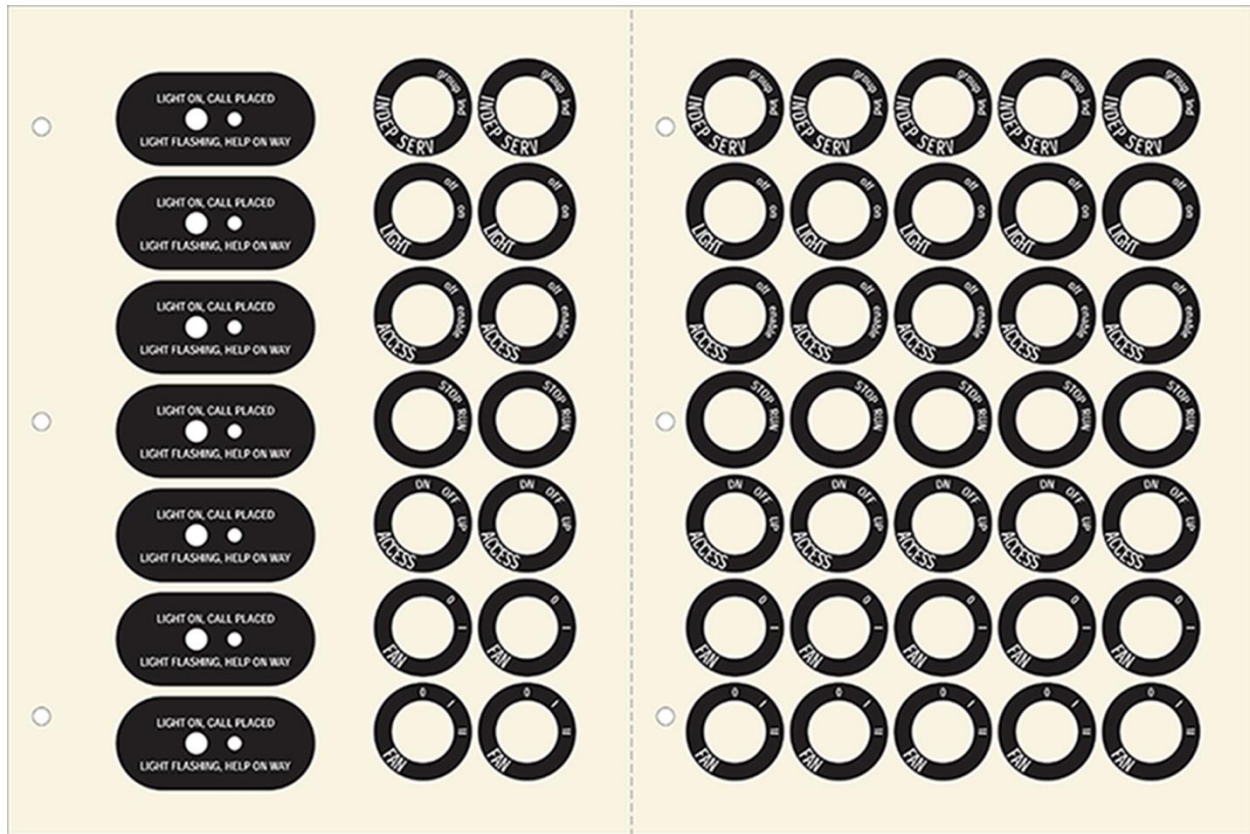

1

W/O VINTAGE		
REF. No.	PART No.	DESCRIPTION
1	AAA102AYK5	Label, Keyswitch Housing (black with white lettering) for G2S COPs Label Sheet Includes Labels: Replacement phone label, RUN/STOP, INDEP SERV, LIGHT, ACCESS (ENABLE), ACCESS (DN-OFF-UP) (7 pcs. each), and FAN (14 pcs.).