

# Escalator Handrail Tension

Spare Parts Leaflet

\*55-GO6814TJ

55-9701AB

55-9701CY

July 1976 / Page 1 of 2

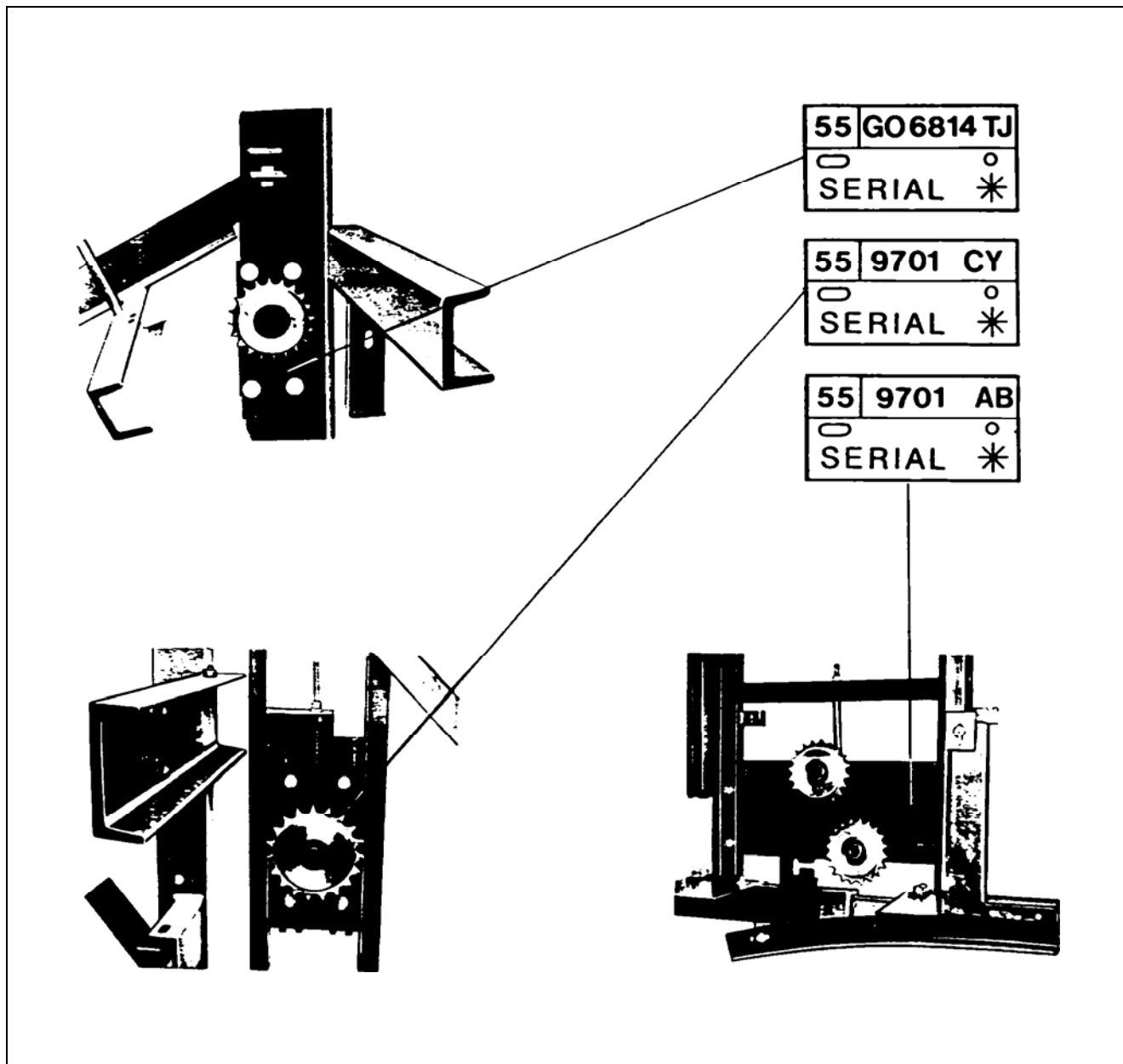

# OTIS

55-GO6814TJ

## Tension Devices: Types GO6814TJ, 9701AB, 9701CY

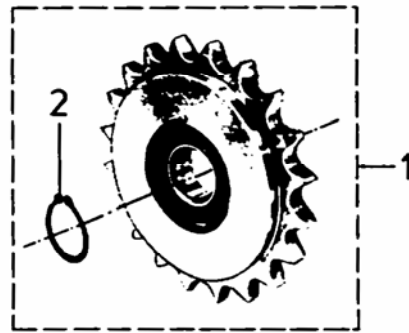
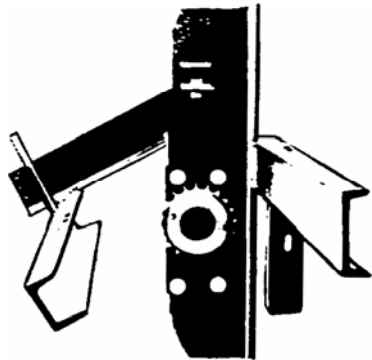

SERIAL G. 01

REF. No.	PART No.	DESCRIPTION
1	GO2215C3	Sprocket, Complete, 20 Teeth, 3/4 in.
2	DIN471 25 x 1.2	Snap Ring

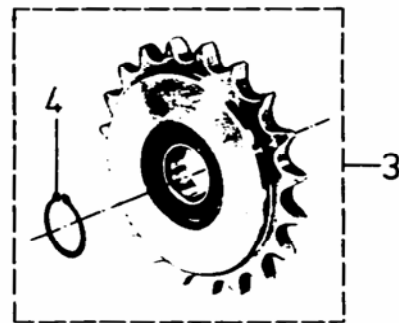
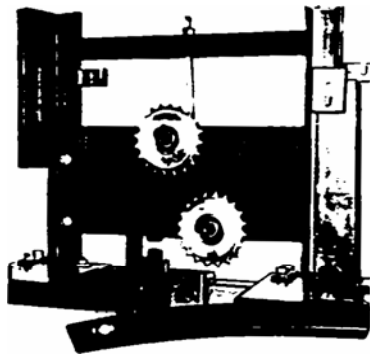

SERIAL G. 01

REF. No.	PART No.	DESCRIPTION
3	GO2215C4	Sprocket, Complete, 20 Teeth, 3/4 in.
4	DIN471 25 x 1.2	Snap Ring

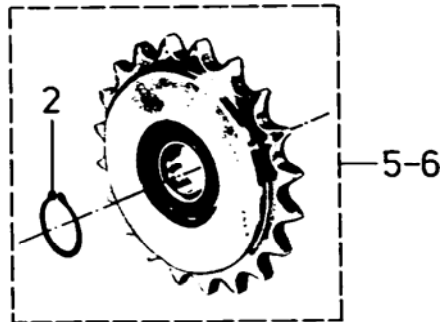
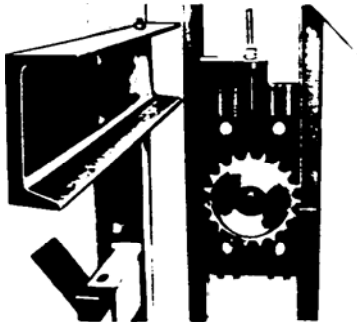

SERIAL G. 01

REF. No.	PART No.	DESCRIPTION
5	GO2215C1	Sprocket, Complete, 19 Teeth, 1 in.
6	GO2215C2	Sprocket, Complete, 17 Teeth, 1-1/4 in.
2	DIN471 25 x 1.2	Snap Ring