



**Leaflet Description****Leaflet Revisions**

<b>Date Revised</b>	<b>Subject Matter Expert</b>	<b>Reason for Revision</b>
August 1, 2002	Wilfried Gohlke	Added part numbers for powder coated combs
November 1, 2002	- - -	- - -

**Related Drawings**

<b>Drawing No.</b>	<b>Title</b>	<b>Drawing No.</b>	<b>Title</b>
GAA453BM	Comb	- - -	- - -

**Related Documents**

<b>Document ID</b>	<b>Title</b>
- - -	- - -

**Subject Matter Expert**

<b>Name</b>	<b>Department</b>
Peter Borchers	Engineering Stadthagen, Germany

**About Spare Parts Leaflets...**

This document lists the lowest replaceable units (LRUs) for the standard version of the product. The LRUs are chosen by a team of Otis associates representing engineering and manufacturing.

While goal of this document is to make parts identification as easy as possible, the document cannot be all-inclusive. Elevator and escalator contracts classified as "special" or "custom" are not addressed here. For such contracts, please refer to specified information, the contract folder, TIPs, Field Education Articles, Construction Letters, etc. for further information.

If you have any suggestions about this document, please contact the subject matter expert listed on this page.

# Escalator Comb

**56-GAA453BM**

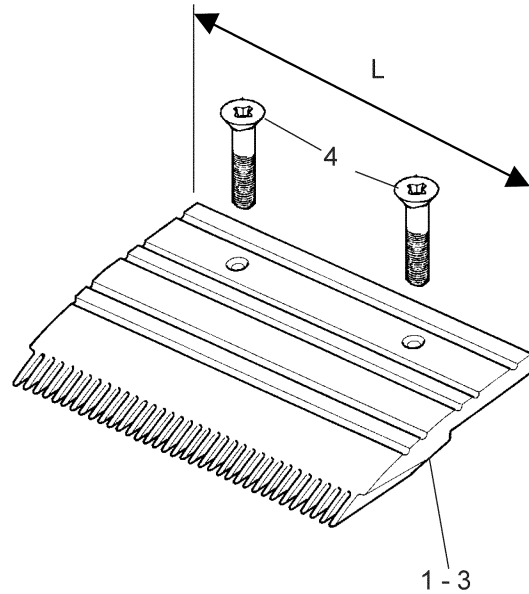
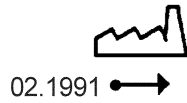

<b>GAA453BM</b>			
<b>REF. No.</b>	<b>PART No.</b>	<b>DESCRIPTION</b>	<b>COATED</b>
1	<del>GO453D4</del> GAA453BM1	Comb L = 203,184 mm, 24 Teeth	w/o Natural Aluminum
2	<del>GO453D5</del> GAA453BM5	Comb L = 206,39 mm, 24 Teeth	
3	<del>GO453D6</del> GAA453BM6	Comb L = 197,994 mm, 23 Teeth	
4	- - -	Hex Socket Counter Sunk Screw DIN7991M6 x 16ST ST-(180487)	

Arrangement of Combs GAA453BM...

TYPE 600

REF.NO. 3
REF.NO. 1
REF.NO. 2

TYPE 800

REF.NO. 3
REF.NO. 1
REF.NO. 1
REF.NO. 2

TYPE 1000

REF.NO. 3
REF.NO. 1
REF.NO. 1
REF.NO. 1
REF.NO. 2

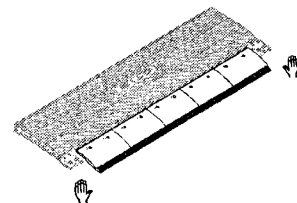

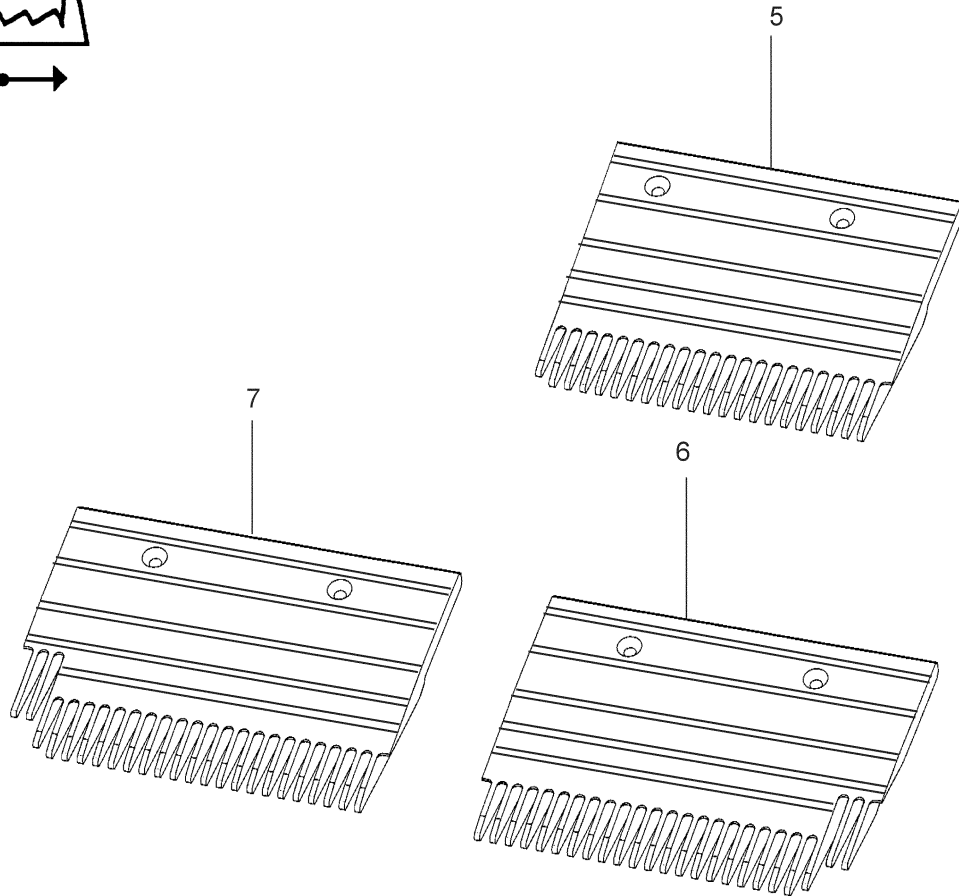
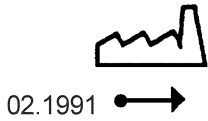

<b>GAA453BM</b>			
<b>REF. No.</b>	<b>PART No.</b>	<b>DESCRIPTION</b>	<b>COATED</b>
5	<del>GO453D1</del> GAA453BM1	Comb L = 203,184 mm, 24 Teeth	w/o Natural Aluminum
6	<del>GO453D3</del> GAA453BM3	Comb L = 206,39 mm, 24 Teeth	
7	<del>GO453D7</del> GAA453BM7	Comb L = 197,994 mm, 23 Teeth	

Arrangement of Combs GAA453BM...

TYPE 600

REF.NO. 7	REF.NO. 5	REF.NO. 6
-----------	-----------	-----------

TYPE 800

REF.NO. 7	REF.NO. 5	REF.NO. 5	REF.NO. 6
-----------	-----------	-----------	-----------

TYPE 1000

REF.NO. 7	REF.NO. 5	REF.NO. 5	REF.NO. 6
-----------	-----------	-----------	-----------

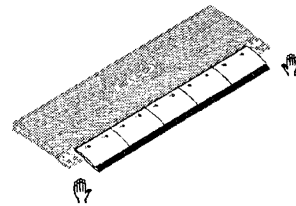

# Escalator Comb

**56-GAA453BM**

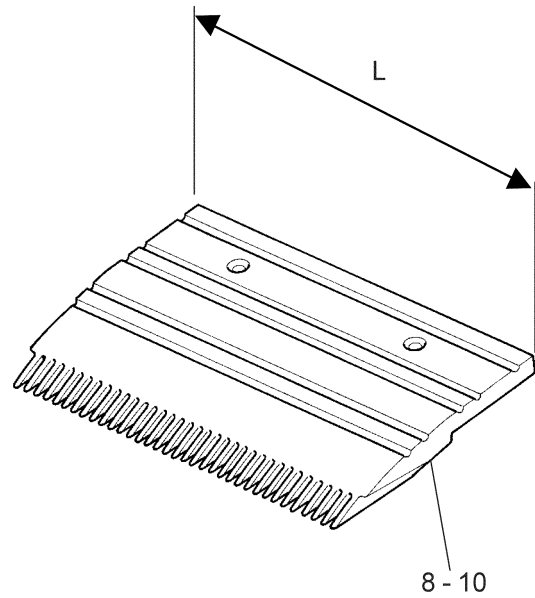
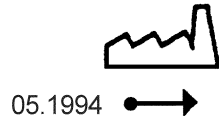

<b>GAA453BM</b>			
<b>REF. No.</b>	<b>PART No.</b>	<b>DESCRIPTION</b>	<b>COATED</b>
8	GAA453BM8	Comb L = 203,184 mm, 24 Teeth	Visible Area PVC Coated 
9	GAA453BM9	Comb L = 206,39 mm, 24 Teeth	
10	GAA453BM10	Comb L = 197,994 mm, 23 Teeth	

Arrangement of Combs GAA453BM...

TYPE 600

REF.NO. 10
REF.NO. 8
REF.NO. 9

TYPE 800

REF.NO. 10
REF.NO. 8
REF.NO. 8
REF.NO. 9

TYPE 1000

REF.NO. 10
REF.NO. 8
REF.NO. 8
REF.NO. 8
REF.NO. 9

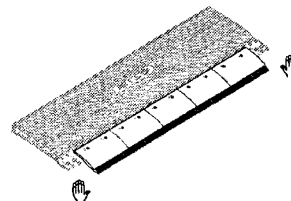

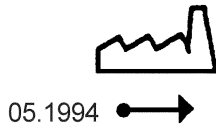

# 56-GAA453BM

# Escalator Comb

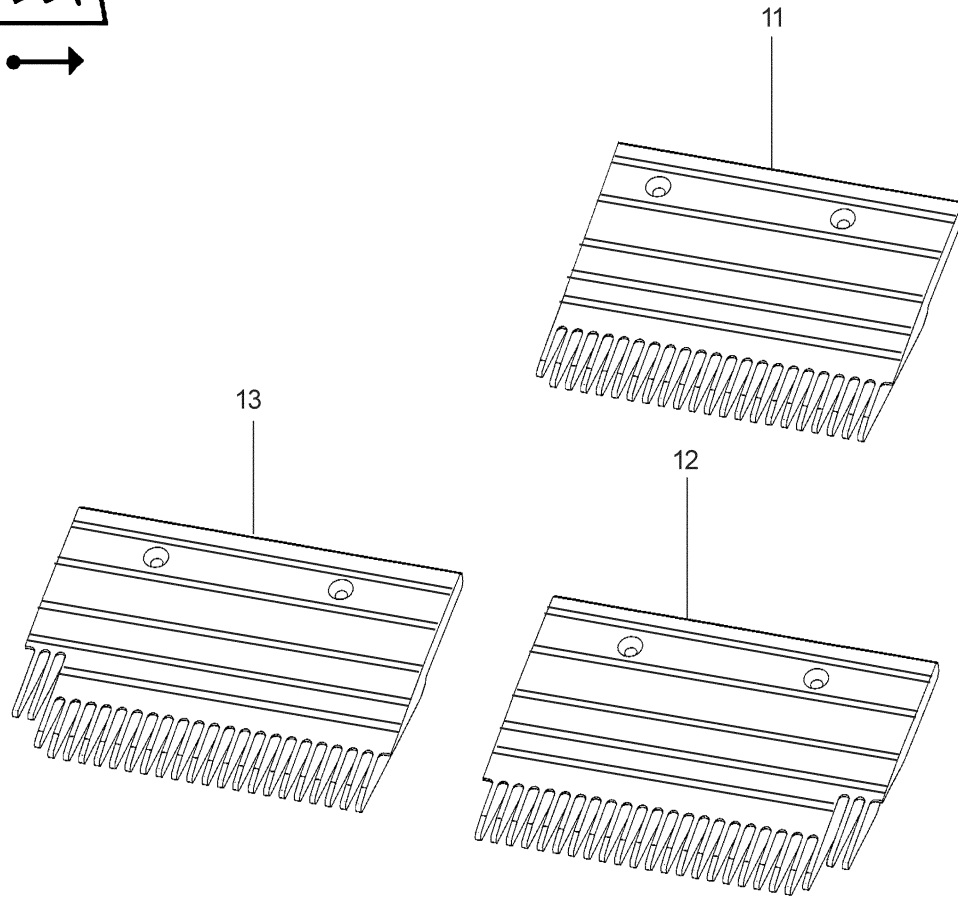

05.1994 →



GAA453BM				
REF. No.	PART No.	DESCRIPTION		COATED
11	GAA453BM8	Comb L = 203,184 mm, 24 Teeth		Visible Area PVC Coated 
12	GAA453BM12	Comb L = 206,39 mm, 24 Teeth	For Step w/Demarcation Insert	
13	GAA453BM11	Comb L = 197,994 mm, 23 Teeth		

Arrangement of Combs GAA453BM...

TYPE 600

REF.NO. 13	REF.NO. 11	REF.NO. 12
------------	------------	------------

TYPE 800

REF.NO. 13	REF.NO. 11	REF.NO. 11	REF.NO. 12
------------	------------	------------	------------

TYPE 1000

REF.NO. 13	REF.NO. 11	REF.NO. 11	REF.NO. 11	REF.NO. 12
------------	------------	------------	------------	------------

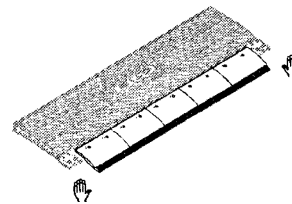

# Escalator Comb

**56-GAA453BM**

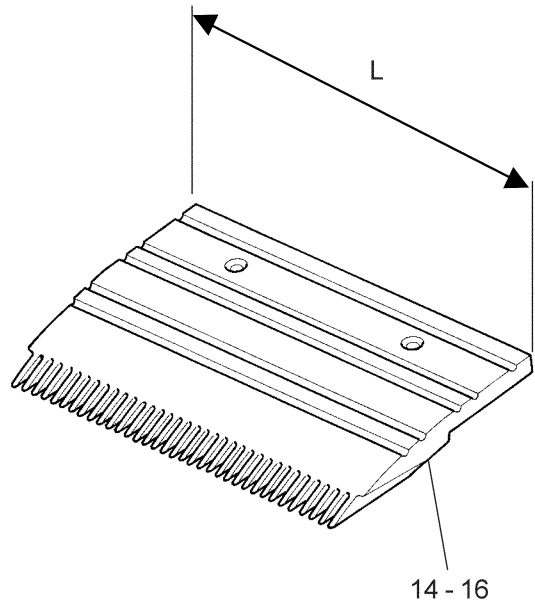

<b>GAA453BM</b>			
<b>REF. No.</b>	<b>PART No.</b>	<b>DESCRIPTION</b>	<b>COATED</b>
14	GAA453BM13	Comb L = 203,184 mm, 24 Teeth	Visible Area Powder Coated 
15	GAA453BM14	Comb L = 206,39 mm, 24 Teeth	
16	GAA453BM15	Comb L = 197,994 mm, 23 Teeth	

Arrangement of Combs GAA453BM...

TYPE 600

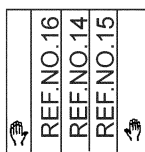

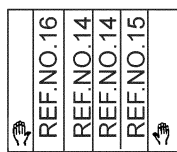

TYPE 800

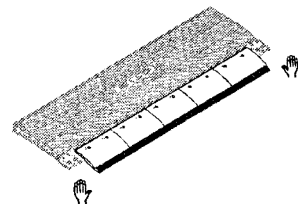
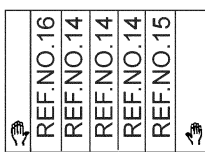

TYPE 1000

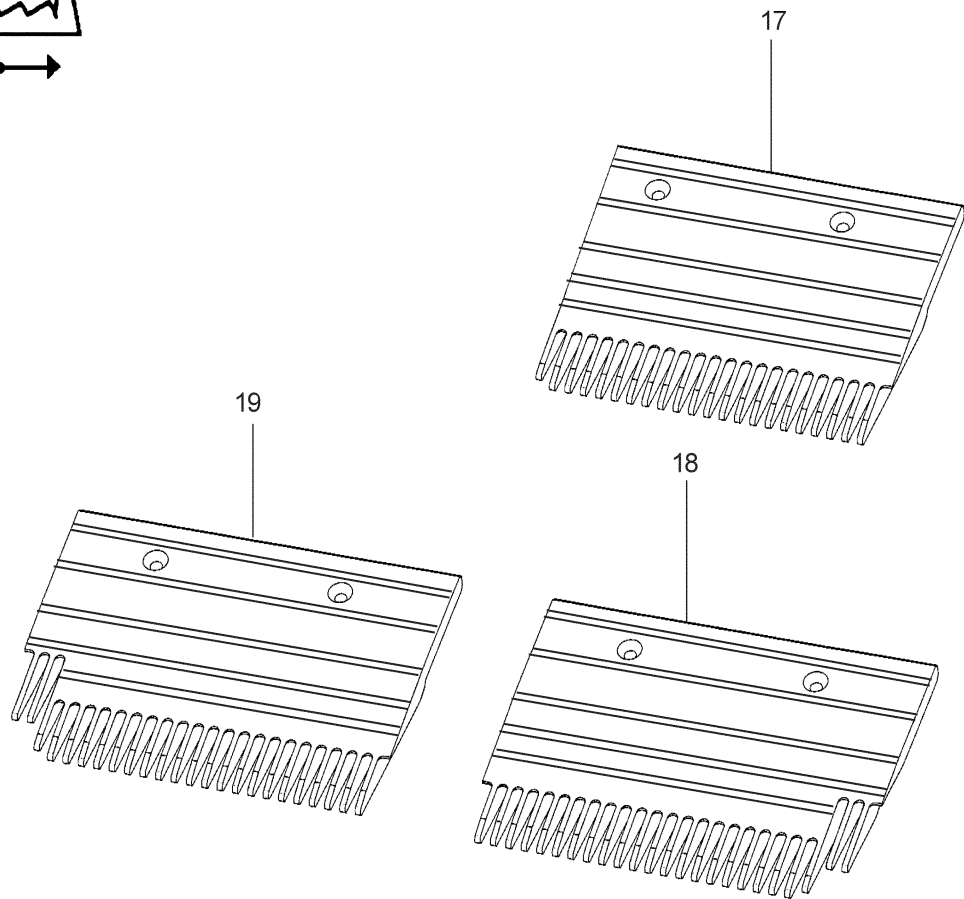



<b>GAA453BM</b>				
<b>REF. No.</b>	<b>PART No.</b>	<b>DESCRIPTION</b>		<b>COATED</b>
17	GAA453BM13	Comb L = 203,184 mm, 24 Teeth		Visible Area Powder Coated 
18	GAA453BM17	Comb L = 206,39 mm, 24 Teeth	For Step w/Demarcation Insert	
19	GAA453BM16	Comb L = 197,994 mm, 23 Teeth		

Arrangement of Combs GAA453BM...

