

**OCE521 Escalator
Balustrade Outer
Decking**

Spare Parts Leaflet

57-ASA03C235

11/01/2006 / Page 1 of 6

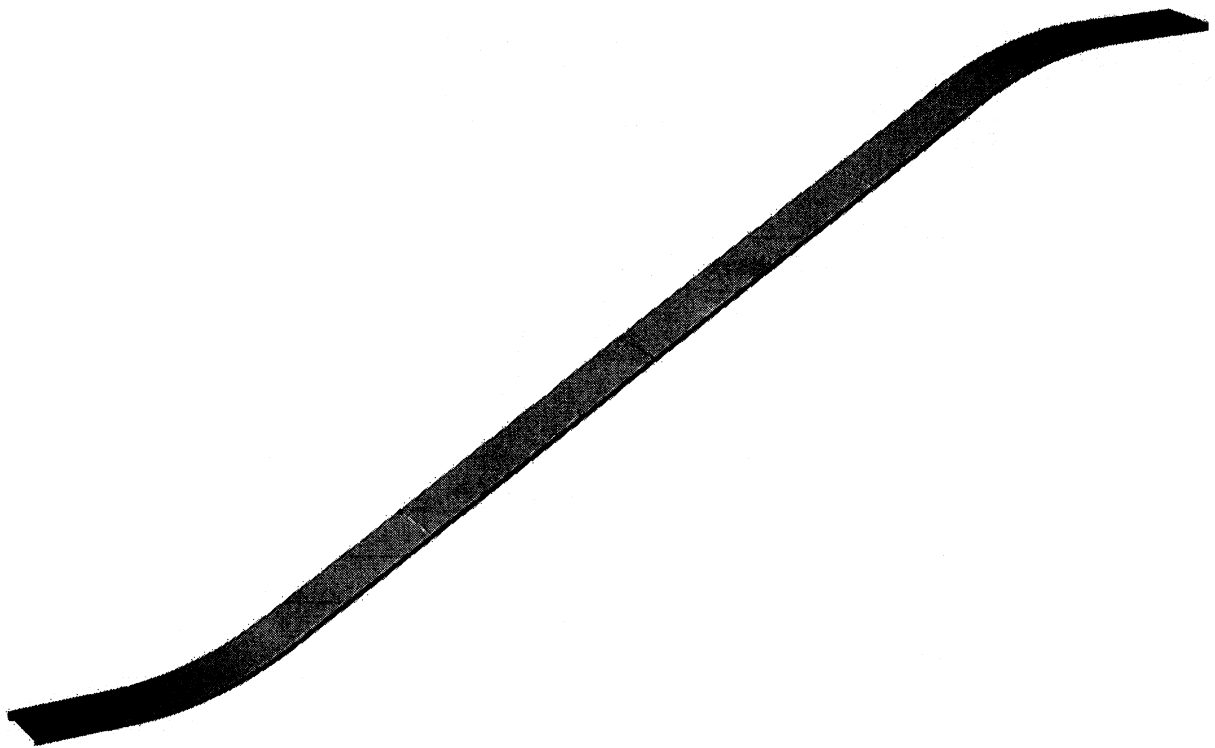

Unpublished Work—©Otis Elevator Co.; 2006

OTIS

Safety First!

SERVICE ENGINEERING

Otis Elevator Company

Bloomfield, Connecticut USA

Leaflet Description

OCE521 Escalator Balustrade Outer Decking

Leaflet Revisions

Date Revised	Subject Matter Expert	Reason for Revision
November 1, 2006		Release

Related Drawings

Drawing No.	Title	Drawing No.	Title
ASA00A809	Outer Decking Setting		

Related Documents

Document ID	Title
BOM	

Subject Matter Expert

Name	Department

About Spare Parts Leaflets...





This document lists the lowest replaceable units (LRUs) for the standard version of the product. The LRUs are chosen by a team of Otis associates representing engineering and manufacturing.

While goal of this document is to make parts identification as easy as possible, the document cannot be all-inclusive. Elevator and escalator contracts classified as "special" or "custom" are not addressed here. For such contracts, please refer to specified information, the contract folder, TIPs, Field Education Articles, Construction Letters, etc. for further information.

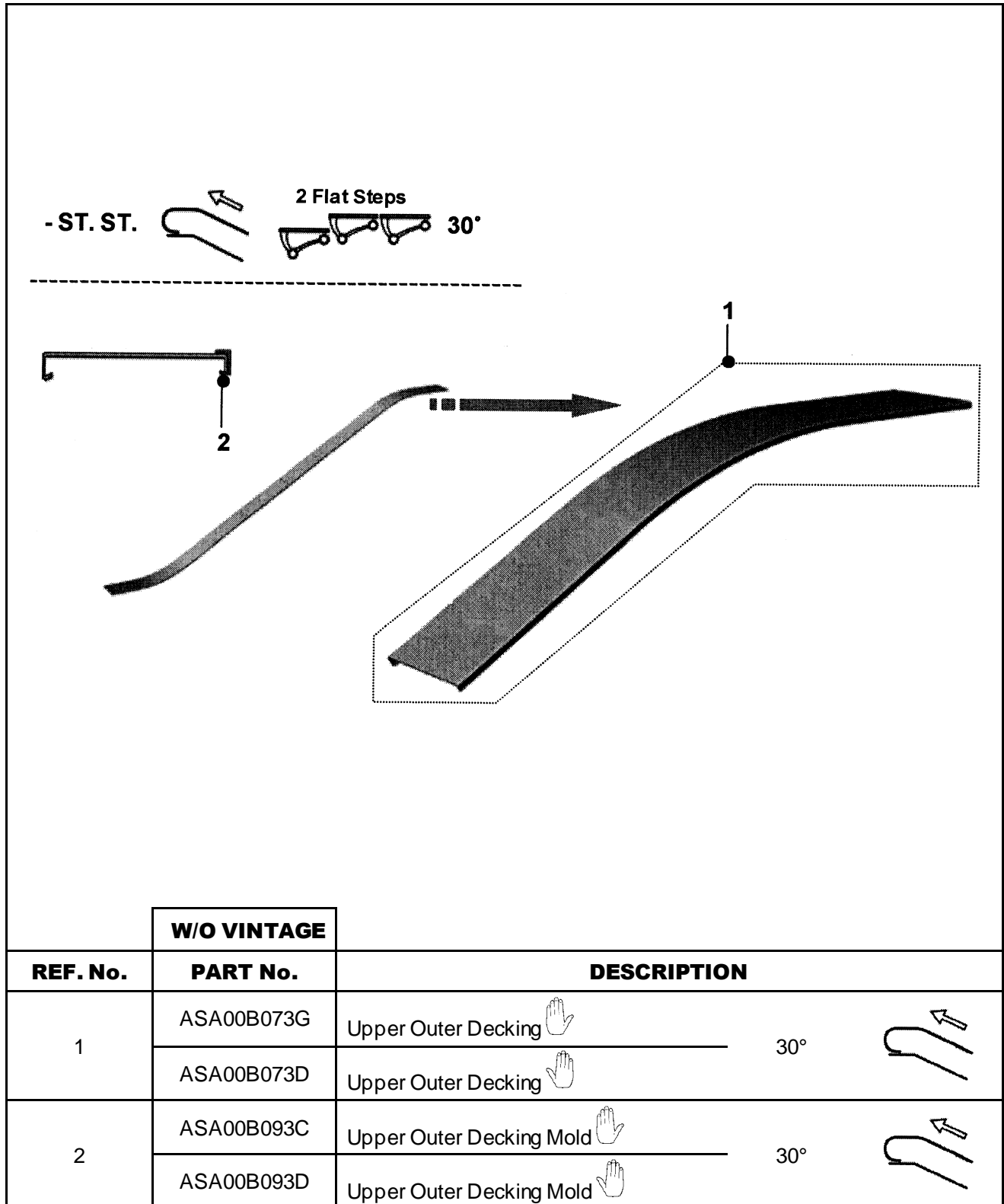
If you have any suggestions about this document, please contact the subject matter expert listed on this page.

Outer Decking







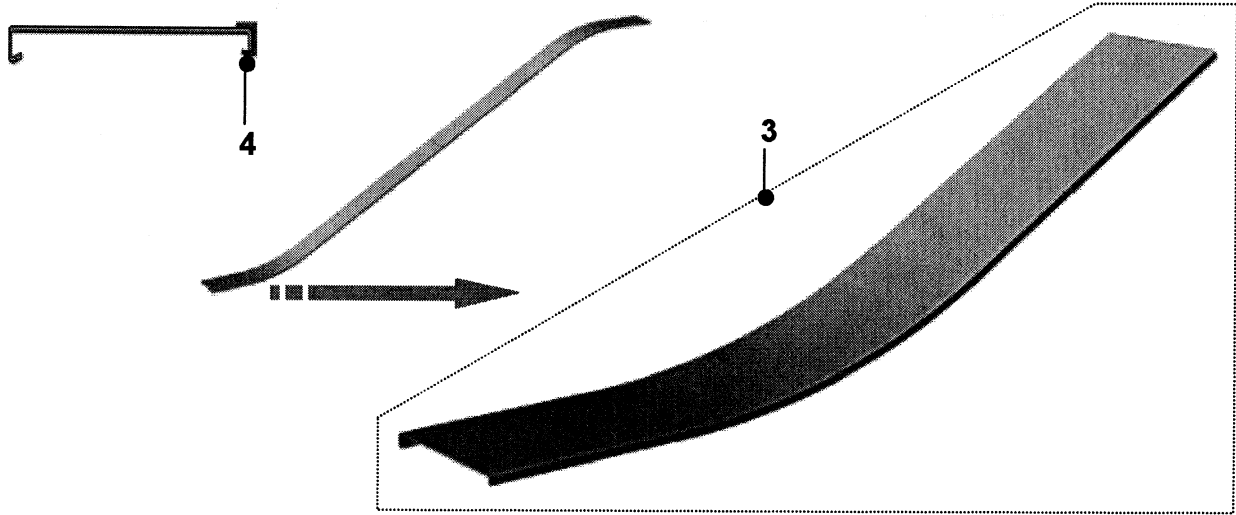

W/O VINTAGE			
REF. No.	PART No.	DESCRIPTION	
1	ASA00B073G	Upper Outer Decking 	30°
	ASA00B073D	Upper Outer Decking 	
2	ASA00B093C	Upper Outer Decking Mold 	30°
	ASA00B093D	Upper Outer Decking Mold 	

OCE521 Escalator Balustrade Outer Decking

- ST. ST.  2 Flat Steps  30°



W/O VINTAGE				
REF. No.	PART No.	DESCRIPTION		
3	ASA00B072C	Lower Outer Decking 	30°	
	ASA00B072G	Lower Outer Decking 		
4	ASA00B094C	Lower Outer Decking Mold 	30°	
	ASA00B094D	Lower Outer Decking Mold 		

Outer Decking

- ST. ST. Inclined Section

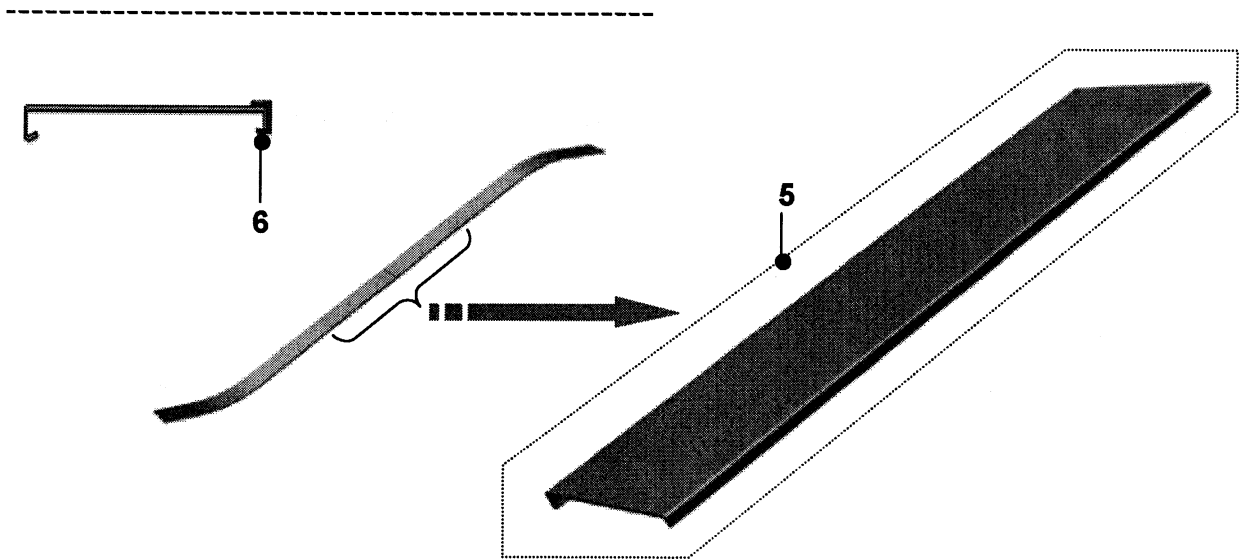

W/O VINTAGE			
REF. No.	PART No.	DESCRIPTION	
5	ASA00B071A	Middle Outer Decking	Length = 3000
	ASA00B071B	Middle Outer Decking	Length = 2000
	ASA00B071C	Middle Outer Decking	Length = 1000
	ASA00B071D	Middle Outer Decking	Length = 1940
	ASA00B071E	Middle Outer Decking	Length = 2040
	ASA00B071F	Middle Outer Decking	Length = 2140
	ASA00B071G	Middle Outer Decking	Length = 2240
	ASA00B071H	Middle Outer Decking	Length = 2340

**OCE521 Escalator Balustrade
Outer Decking**

- ST. ST. Inclined Section

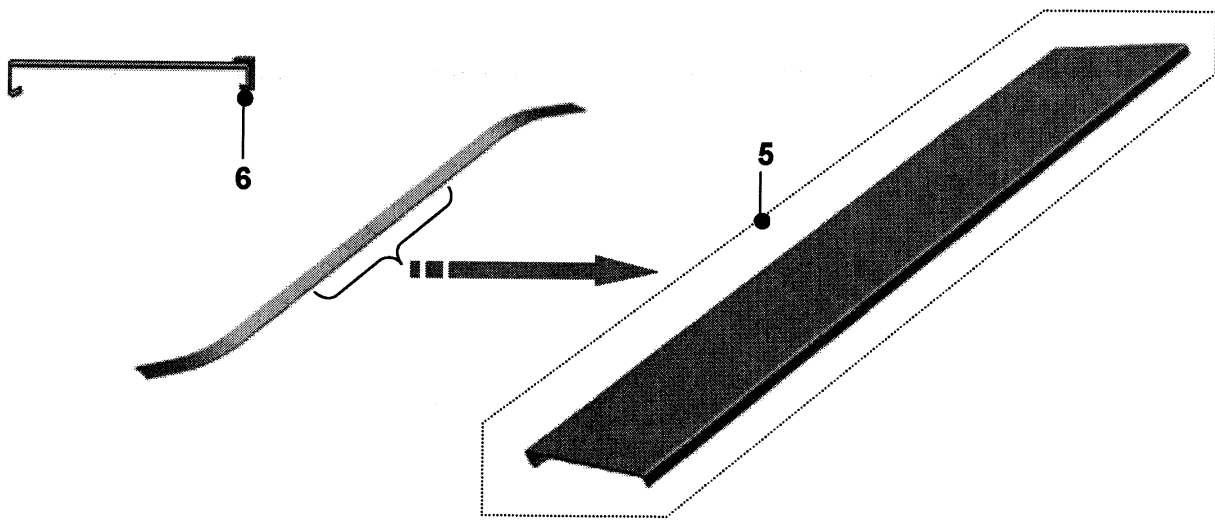

		W/O VINTAGE	
REF. No.	PART No.	DESCRIPTION	
5	ASA00B071J	Middle Outer Decking	Length = 2440
	ASA00B071K	Middle Outer Decking	Length = 2540
	ASA00B071L	Middle Outer Decking	Length = 2640
	ASA00B071M	Middle Outer Decking	Length = 2740
	ASA00B071N	Middle Outer Decking	Length = 2840
6	ASA00C181B	Middle Outer Decking	Length = 2000
	ASA00C181C	Middle Outer Decking	Length = 3100