

**OCE521 Escalator  
Balustrade Skirt Panel**

**Spare Parts Leaflet**

**57-ASA03C236**

**January 2, 2007 / Page 1 of 9**

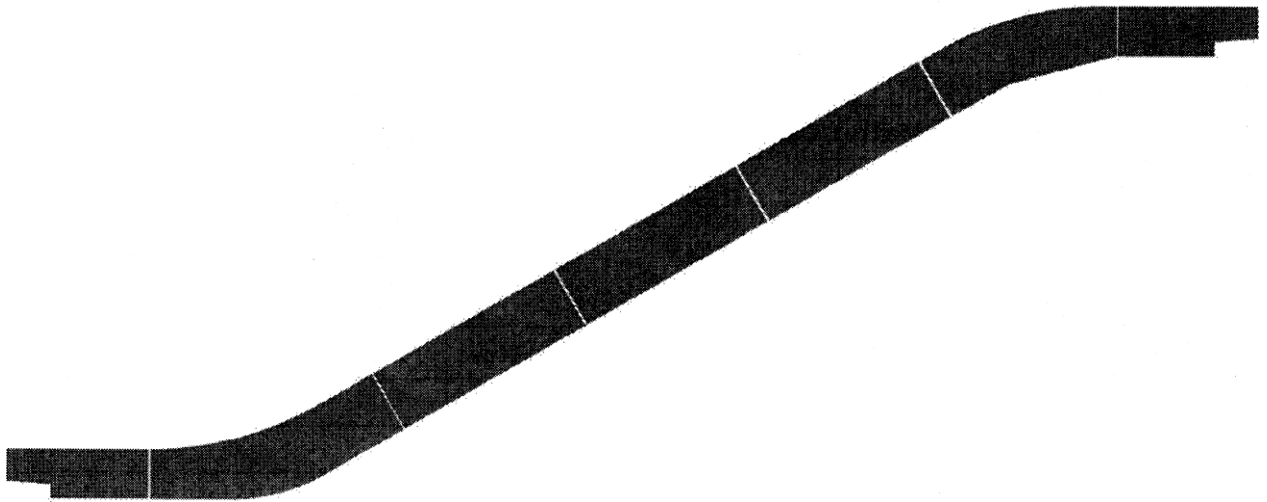

Unpublished Work—© Otis Elevator Co.; 2006

**OTIS**

**Safety First!**

**SERVICE ENGINEERING**  
**Otis Elevator Company**  
**Bloomfield, Connecticut USA**

**Leaflet Description**

OCE521 escalator balustrade skirt panel.

**Leaflet Revisions**

<b>Date Revised</b>	<b>Subject Matter Expert</b>	<b>Reason for Revision</b>
November 1, 2006	---	New SPL f from Korea
January 2, 2007	Tom Charney	Release SPL in NSAA.

**Related Drawings**

<b>Drawing No.</b>	<b>Title</b>	<b>Drawing No.</b>	<b>Title</b>
ASA00A866	Skirt Panel Setting	---	---
---	---	---	---

**Related Documents**

<b>Document ID</b>	<b>Title</b>
BOM	---
---	---

**Subject Matter Expert**

<b>Name</b>	<b>Department</b>
Tom Charney	OSC Service Engineering

**About Spare Parts Leaflets...**

This document lists the lowest replaceable units (LRUs) for the standard version of the product. The LRUs are chosen by a team of Otis associates representing engineering and manufacturing.

While goal of this document is to make parts identification as easy as possible, the document cannot be all-inclusive. Elevator and escalator contracts classified as "special" or "custom" are not addressed here. For such contracts, please refer to specified information, the contract folder, TIPs, Field Education Articles, Construction Letters, etc. for further information.

If you have any suggestions about this document, please contact the subject matter expert listed on this page.

# OCE521 Escalator Balustrade Skirt Panel

**57-ASA03C236**

- ST. ST.  
- Teflon Coated

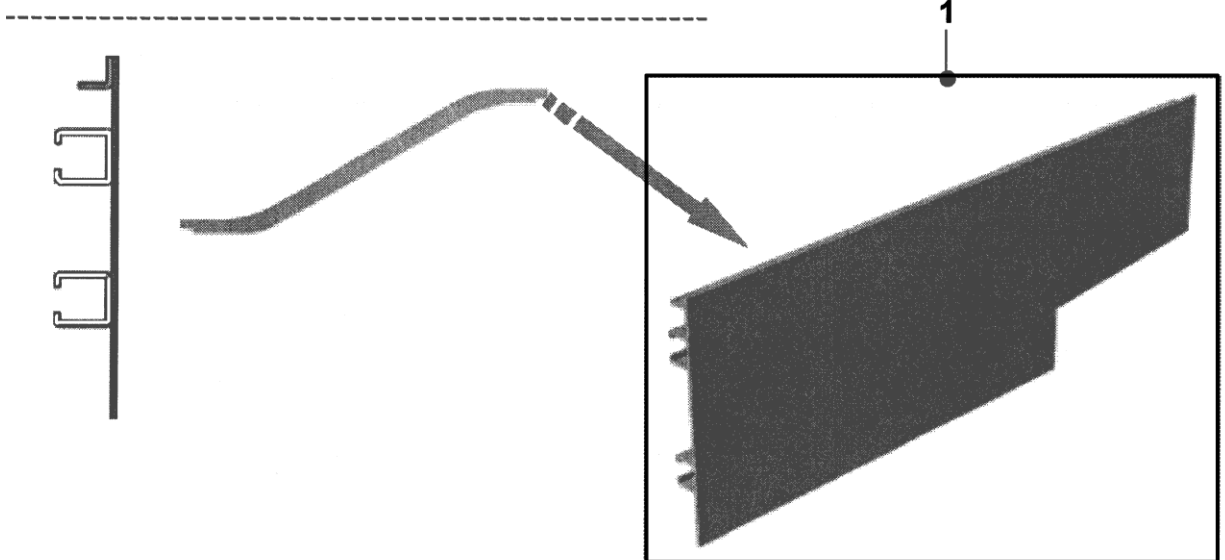
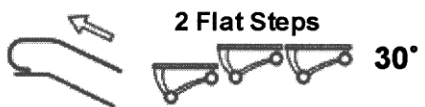



W/O VINTAGE		
REF. No.	PART No.	DESCRIPTION
1	ASA00C204H	Skirt Panel (TU),  , 30°, Upper Landing
	ASA00C204G	Skirt Panel (TU),  , 30°, Upper Landing

**57-ASA03C236**

# OCE521 Escalator Balustrade Skirt Panel

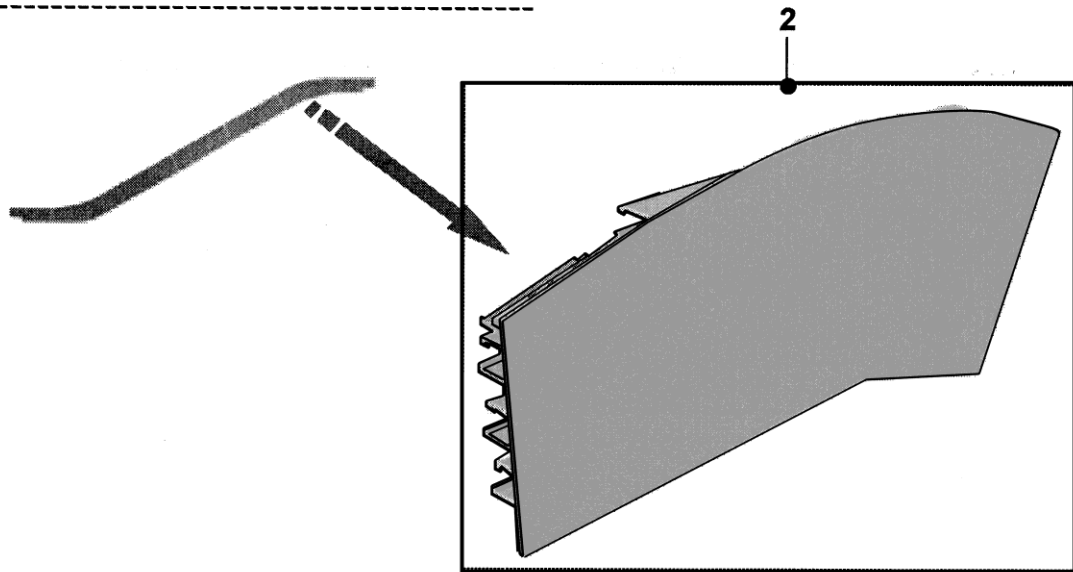
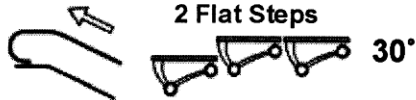
- ST. ST.
- Teflon Coated



	<b>W/O VINTAGE</b>	
<b>REF. No.</b>	<b>PART No.</b>	<b>DESCRIPTION</b>
2	ASA00B095D	Skirt Panel (U),  , 30°, Upper Landing
	ASA00B095C	Skirt Panel (U),  , 30°, Upper Landing

# OCE521 Escalator Balustrade Skirt Panel



**57-ASA03C236**

- ST. ST.  
- Teflon Coated

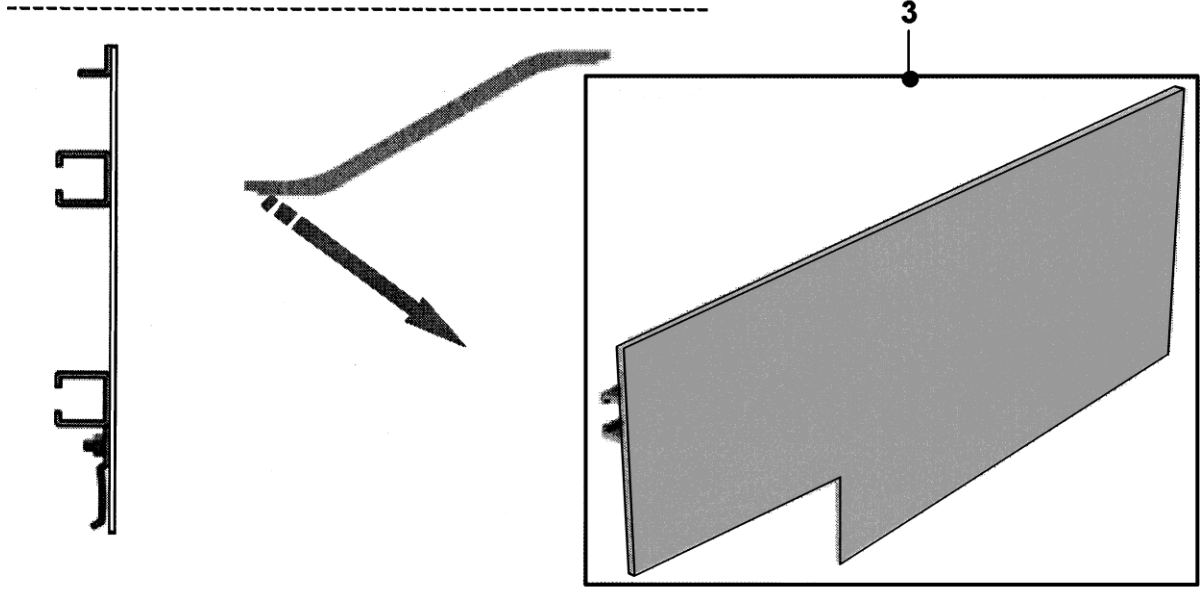

2 Flat Steps 30°





W/O VINTAGE		
REF. No.	PART No.	DESCRIPTION
3	ASA00C026G	Skirt Panel (TL),  , 30°, Lower Landing
	ASA00C026H	Skirt Panel (TL),  , 30°, Lower Landing

**57-ASA03C236**

# OCE521 Escalator Balustrade Skirt Panel

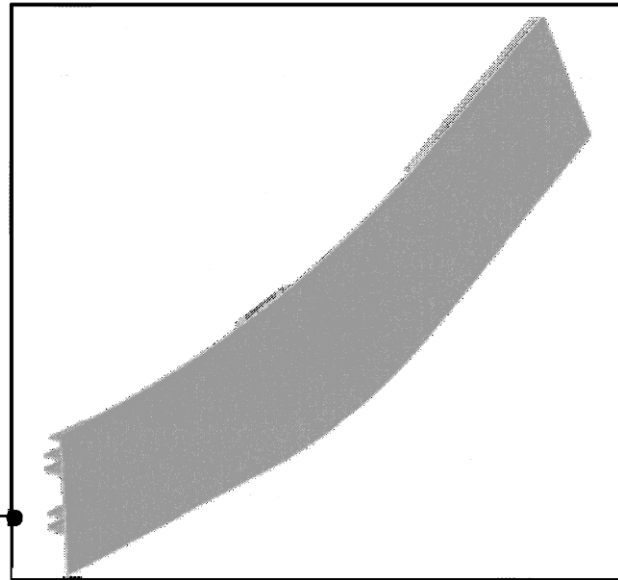
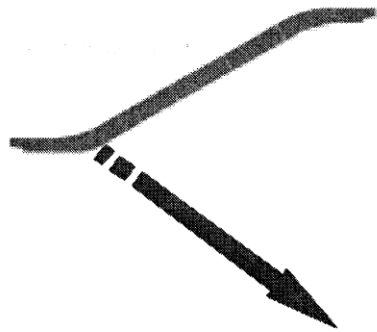
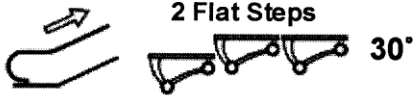
- ST. ST.  
- Teflon Coated









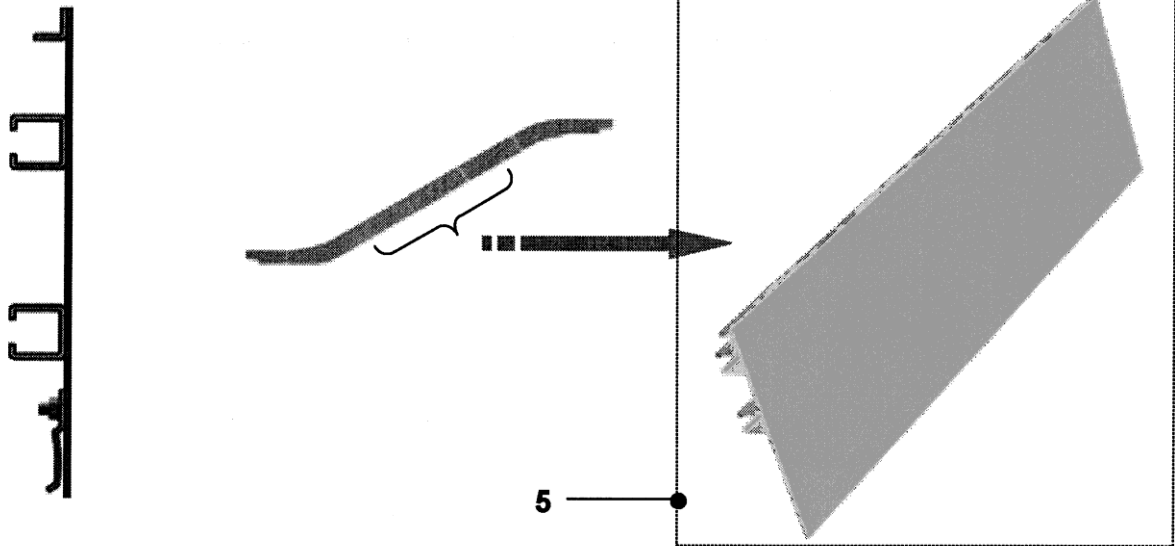

W/O VINTAGE		
REF. No.	PART No.	DESCRIPTION
4	ASA00B096C	Skirt Panel (L),  , 30°, Lower Landing
	ASA00B096D	Skirt Panel (L),  , 30°, Lower Landing

**57-ASA03C236**

# OCE521 Escalator Balustrade Skirt Panel

- ST. ST.
- Teflon Coated    Inclined Section











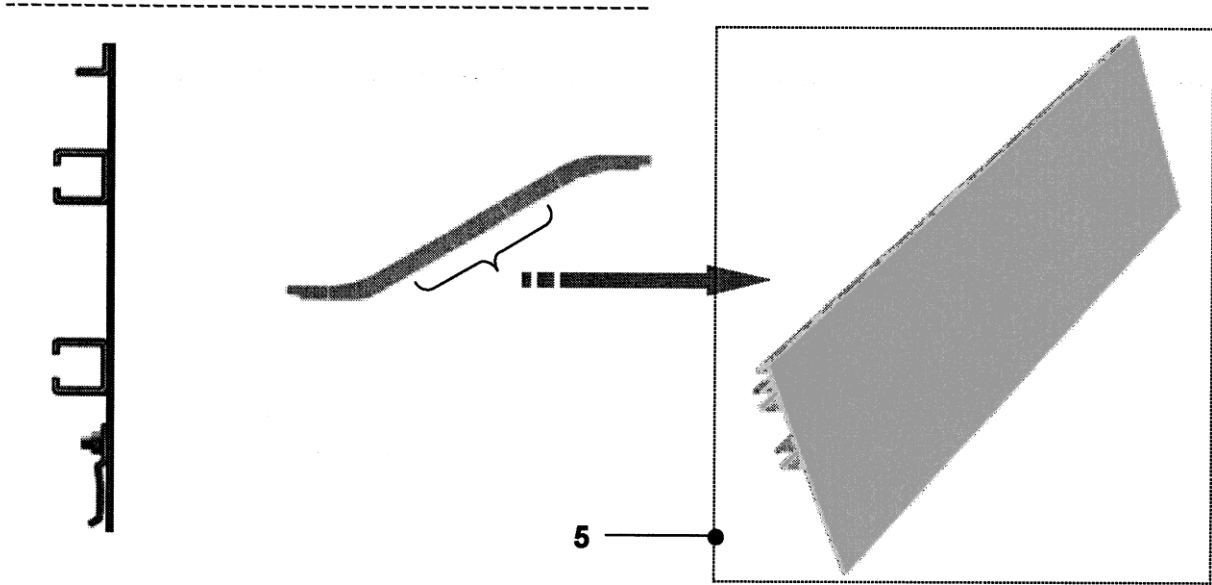

W/O VINTAGE		
REF. No.	PART No.	DESCRIPTION
5	ASA00C199C	Skirt Panel (MU),  , 900 mm L
	ASA00C199D	Skirt Panel (MU),  , 900 mm L
	ASA00B963A	Skirt Panel (M), 2000 mm L
	ASA00B963B	Skirt Panel (M), 1000 mm L
	ASA00B963C	Skirt Panel (M),  , 1020 mm L
	ASA00B963D	Skirt Panel (M),  , 1020 mm L
	ASA00B963E	Skirt Panel (M),  , 1120 mm L
	ASA00B963F	Skirt Panel (M),  , 1120 mm L
	ASA00B963G	Skirt Panel (M),  , 1220 mm L
	ASA00B963H	Skirt Panel (M),  , 1220 mm L

# OCE521 Escalator Balustrade Skirt Panel

**57-ASA03C236**

- ST. ST.
- Teflon Coated    Inclined Section



W/O VINTAGE		
REF. No.	PART No.	DESCRIPTION
5	ASA00B963J	Skirt Panel (M),  , 1320 mm L
	ASA00B963K	Skirt Panel (M),  , 1320 mm L
	ASA00B963L	Skirt Panel (M),  , 1420 mm L
	ASA00B963M	Skirt Panel (M),  , 1420 mm L
	ASA00B963N	Skirt Panel (M),  , 1520 mm L
	ASA00B963P	Skirt Panel (M),  , 1520 mm L
	ASA00B963Q	Skirt Panel (M),  , 1620 mm L
	ASA00B963R	Skirt Panel (M),  , 1620 mm L
	ASA00B963S	Skirt Panel (M),  , 1720 mm L
	ASA00B963T	Skirt Panel (M),  , 1720 mm L





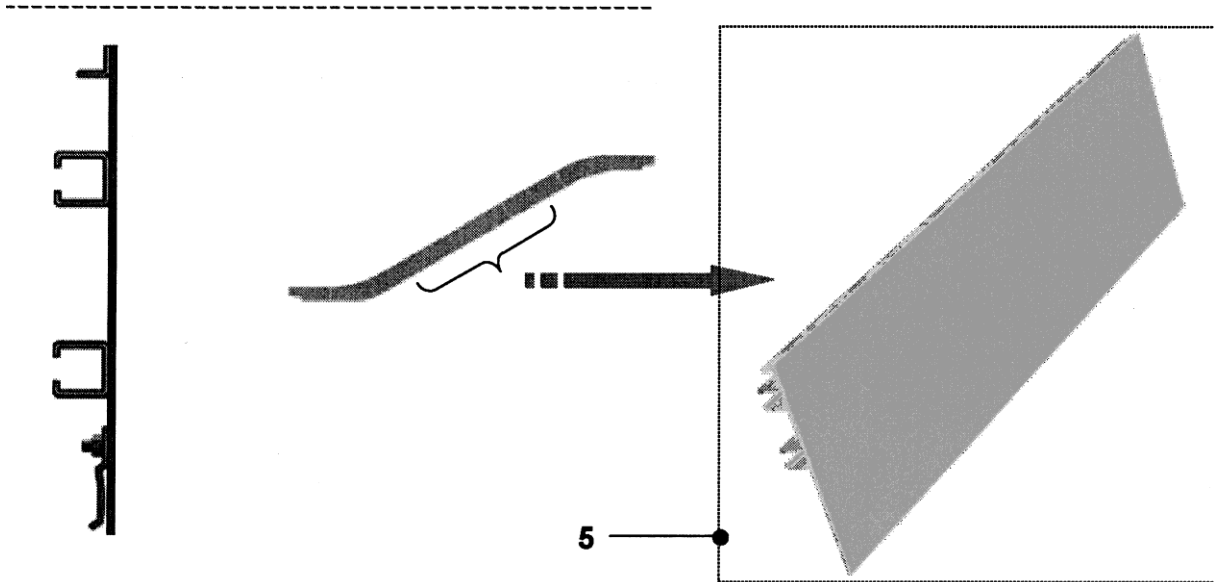

**57-ASA03C236**

# OCE521 Escalator Balustrade Skirt Panel

- ST. ST.
- Teflon Coated    Inclined Section



W/O VINTAGE		
REF. No.	PART No.	DESCRIPTION
5	ASA00B963U	Skirt Panel (M),  , 1820 mm L
	ASA00B963V	Skirt Panel (M),  , 1820 mm L
	ASA00B963W	Skirt Panel (M),  , 1920 mm L
	ASA00B963X	Skirt Panel (M),  , 1920 mm L