

**Trav-O-Lator® 606 NCT,
Escalator 513 NPE-SR, 506
NCE: Skirt Panel Lighting**

**Spare Parts Leaflet
57-GAA26427F**

April 1, 2002 / Page 1 of 33

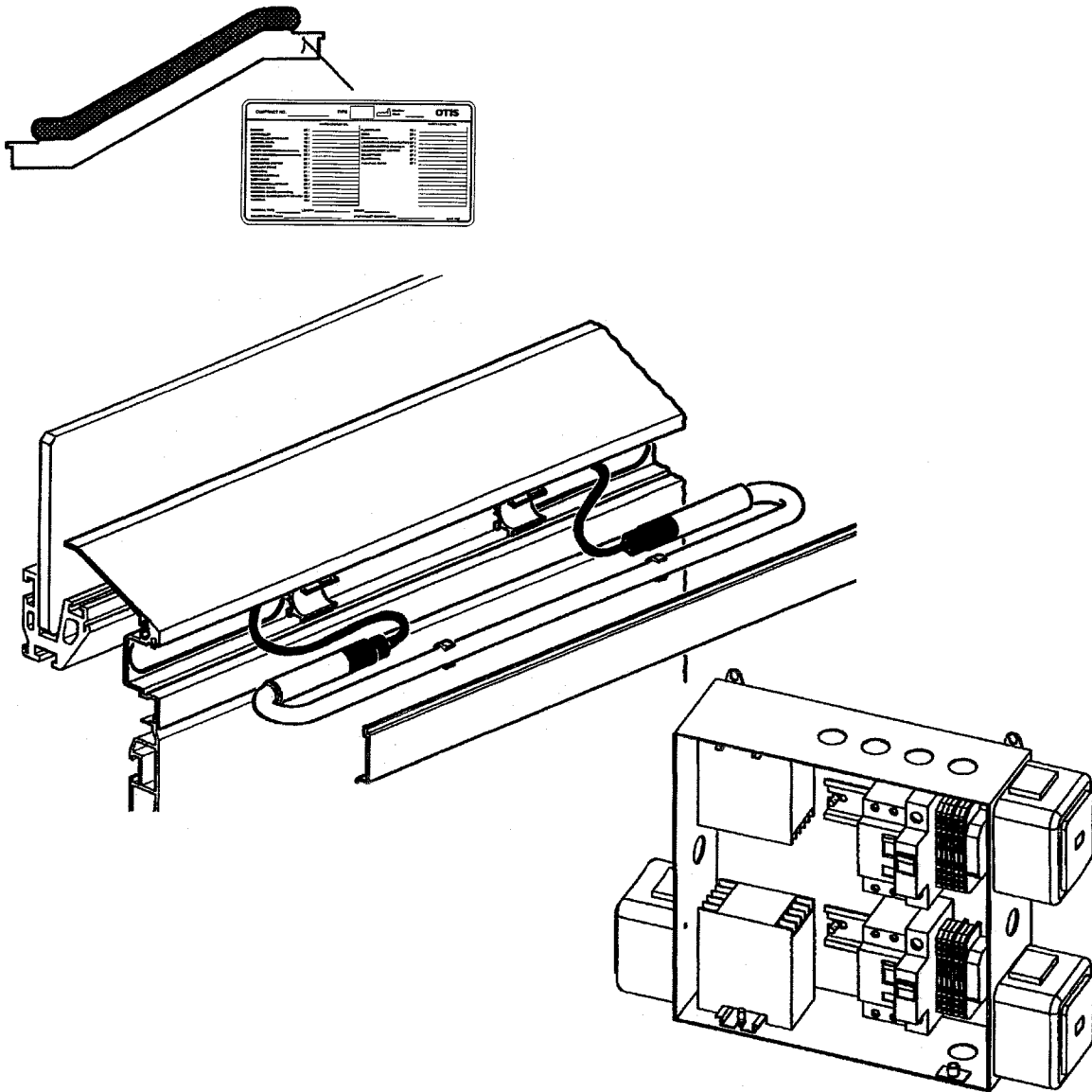

Unpublished Work—© Otis Elevator Co.; 2002

OTIS

Safety First!





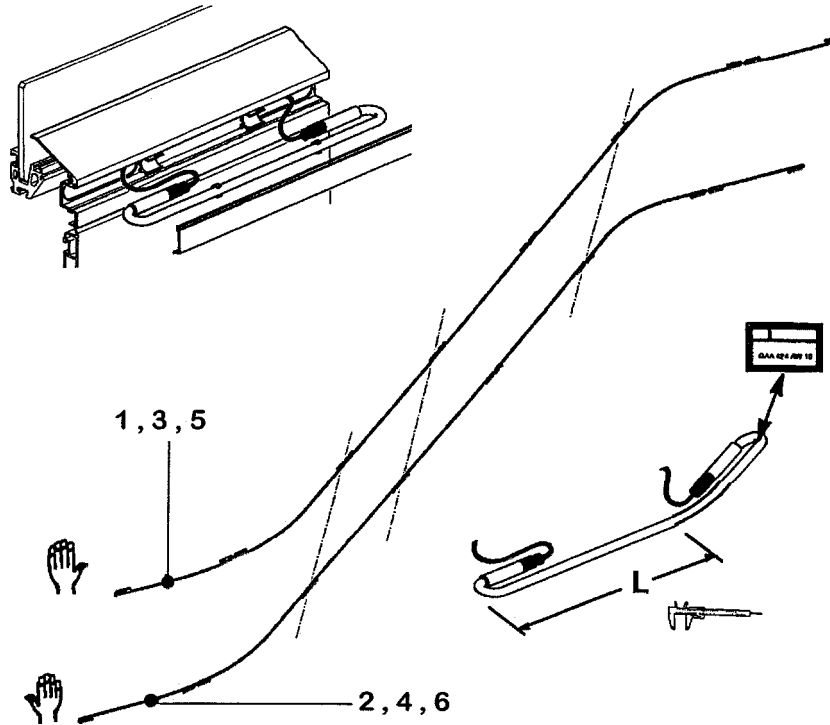

ENGINEERING
Otis Escalator Systems
Stadthagen, Germany

57-GAA26427F

**Trav-O-Lator® 606 NCT, Escalator 513
NPE-SR, 506 NCE: Skirt Panel Lighting**

506 NCE 







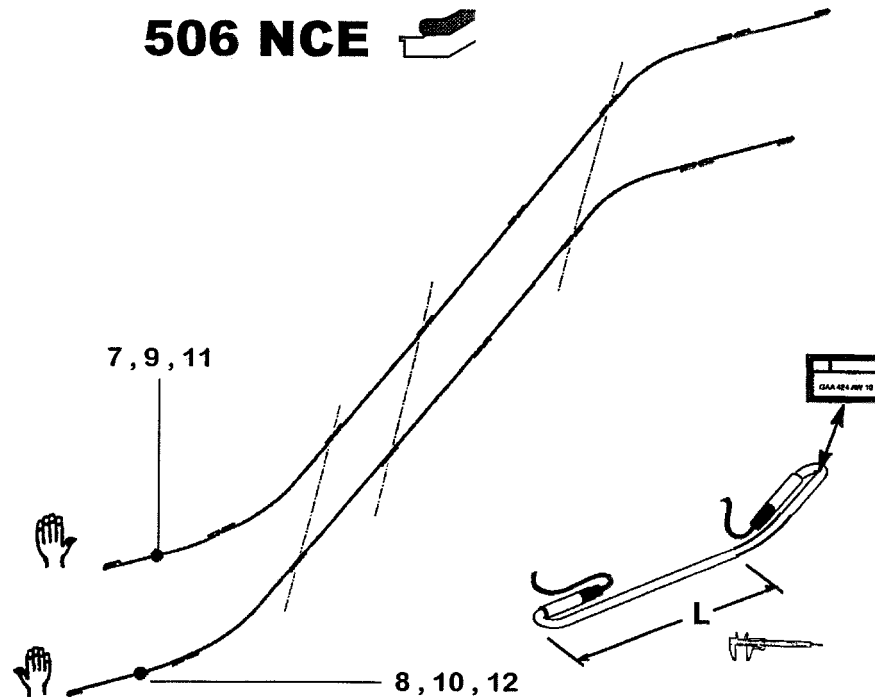

GAA26427F		
REF. No.	PART No.	DESCRIPTION
1	GAA424AW10 GBA424AW10 GCA424AW10	Fluorescent Lamp,  , L = 538 mm, 30°, Code EN 115
2	GAA424AW11 GBA424AW11 GCA424AW11	Fluorescent Lamp,  , L = 297 mm, 30°, Code EN 115
3	GAA424AW12 GBA424AW12 GCA424AW12	Fluorescent Lamp,  , L = 484 mm, 30°, Region APA
4	GAA424AW13 GBA424AW13 GCA424AW13	Fluorescent Lamp,  , L = 243 mm, 30°, Region APA
5	GAA424AW14 GBA424AW14 GCA424AW14	Fluorescent Lamp,  , L = 625 mm, 30°, Region NAA
6	GAA424AW15 GBA424AW15 GCA424AW15	Fluorescent Lamp,  , L = 384 mm, 30°, Region NAA

**Trav-O-Lator® 606 NCT, Escalator 513
NPE-SR, 506 NCE: Skirt Panel Lighting**

57-GAA26427F



GAA26427F		
REF. No.	PART No.	DESCRIPTION
7	GAA424AW16 GBA424AW16 GCA424AW16	Fluorescent Lamp,  , L = 938 mm, 30°, Code EN 115
8	GAA424AW17 GBA424AW17 GCA424AW17	Fluorescent Lamp,  , L = 697 mm, 30°, Region APA
9	GAA424AW18 GBA424AW18 GCA424AW18	Fluorescent Lamp,  , L = 1032 mm, 30°, Region NAA
10	GAA424AW19 GBA424AW19 GCA424AW19	Fluorescent Lamp,  , L = 791 mm, 30°, Region NAA
11	GAA424AW40 GBA424AW40 GCA424AW40	Fluorescent Lamp,  , L = 494 mm, 35°, Code EN 115
12	GAA424AW41 GBA424AW41 GCA424AW41	Fluorescent Lamp,  , L = 253 mm, 35°, Code EN 115

57-GAA26427F

**Trav-O-Lator® 606 NCT, Escalator 513
NPE-SR, 506 NCE: Skirt Panel Lighting**

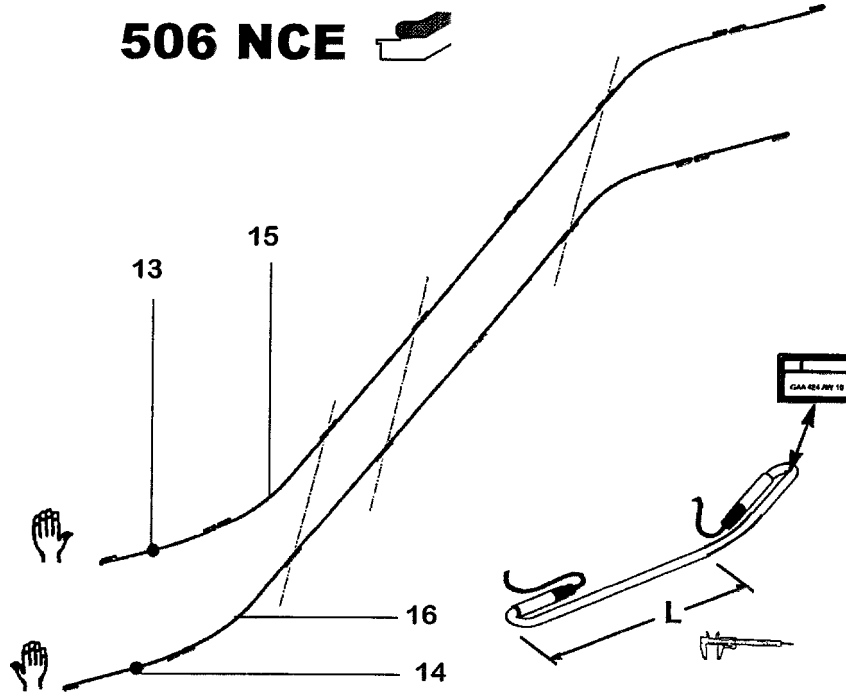

GAA26427F		
REF. No.	PART No.	DESCRIPTION
13	GAA424AW42 GBA424AW42 GCA424AW42	Fluorescent Lamp, , L = 894 mm, 35°, Code EN 115
	GCA424AW23	Fluorescent Lamp, , L = 234 mm, 30°, Code JIS
14	GAA424AW43 GBA424AW43 GCA424AW43	Fluorescent Lamp, , L = 653 mm, 35°, Code EN 115
	GCA424AW24	Fluorescent Lamp, , L = ---, 30°, Code JIS
15	GAA424AW20 GBA424AW20 GCA424AW20	Fluorescent Lamp, , L = 762 mm, 30° + 35°
16	GAA424AW21 GBA424AW21 GCA424AW21	Fluorescent Lamp, , L = 762 mm, 30° + 35°

**Trav-O-Lator® 606 NCT, Escalator 513
NPE-SR, 506 NCE: Skirt Panel Lighting**

57-GAA26427F

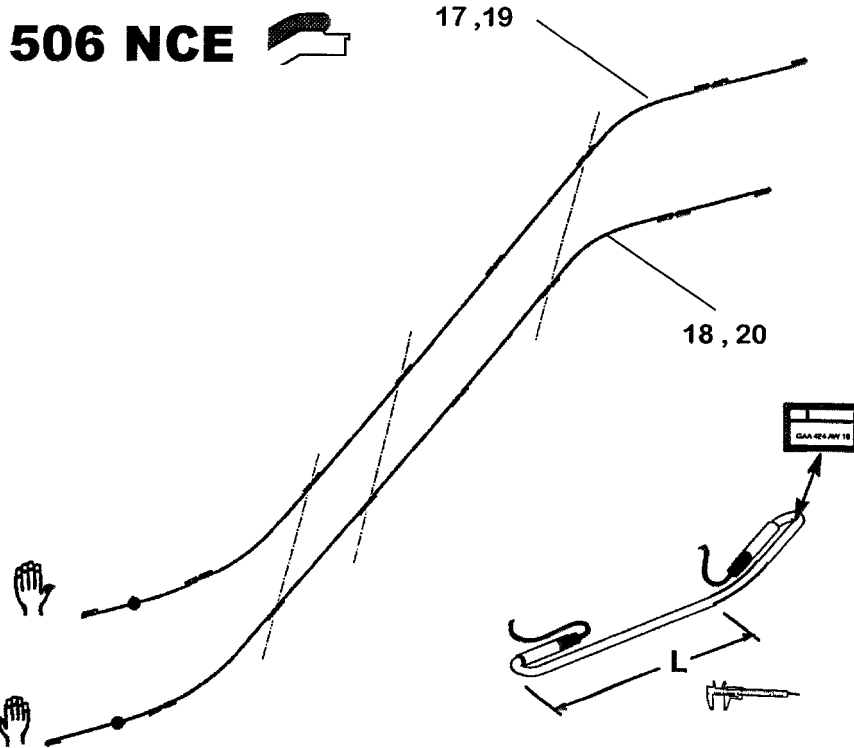

GAA26427F		
REF. No.	PART No.	DESCRIPTION
17	GAA424AW30 GBA424AW30 GCA424AW30	Fluorescent Lamp, , 30°, All Except Code JIS
18	GAA424AW31 GBA424AW31 GCA424AW31	Fluorescent Lamp, , 30°, All Except Code JIS
19	GAA424AW32 GBA424AW32 GCA424AW32	Fluorescent Lamp, , 35°, Code EN 115
	GCA424AW34	Fluorescent Lamp, , 30°, Code JIS
20	GAA424AW33 GBA424AW33 GCA424AW33	Fluorescent Lamp, , 35°, Code EN 115
	GCA424AW35	Fluorescent Lamp, , 30°, Code JIS

57-GAA26427F

**Trav-O-Lator® 606 NCT, Escalator 513
NPE-SR, 506 NCE: Skirt Panel Lighting**

506 NCE

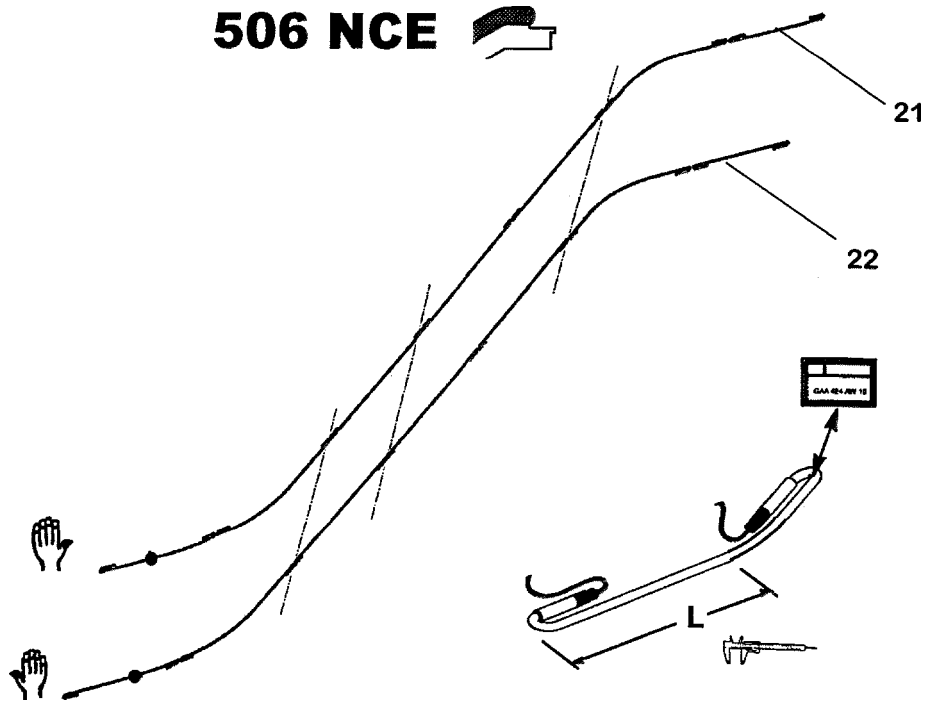







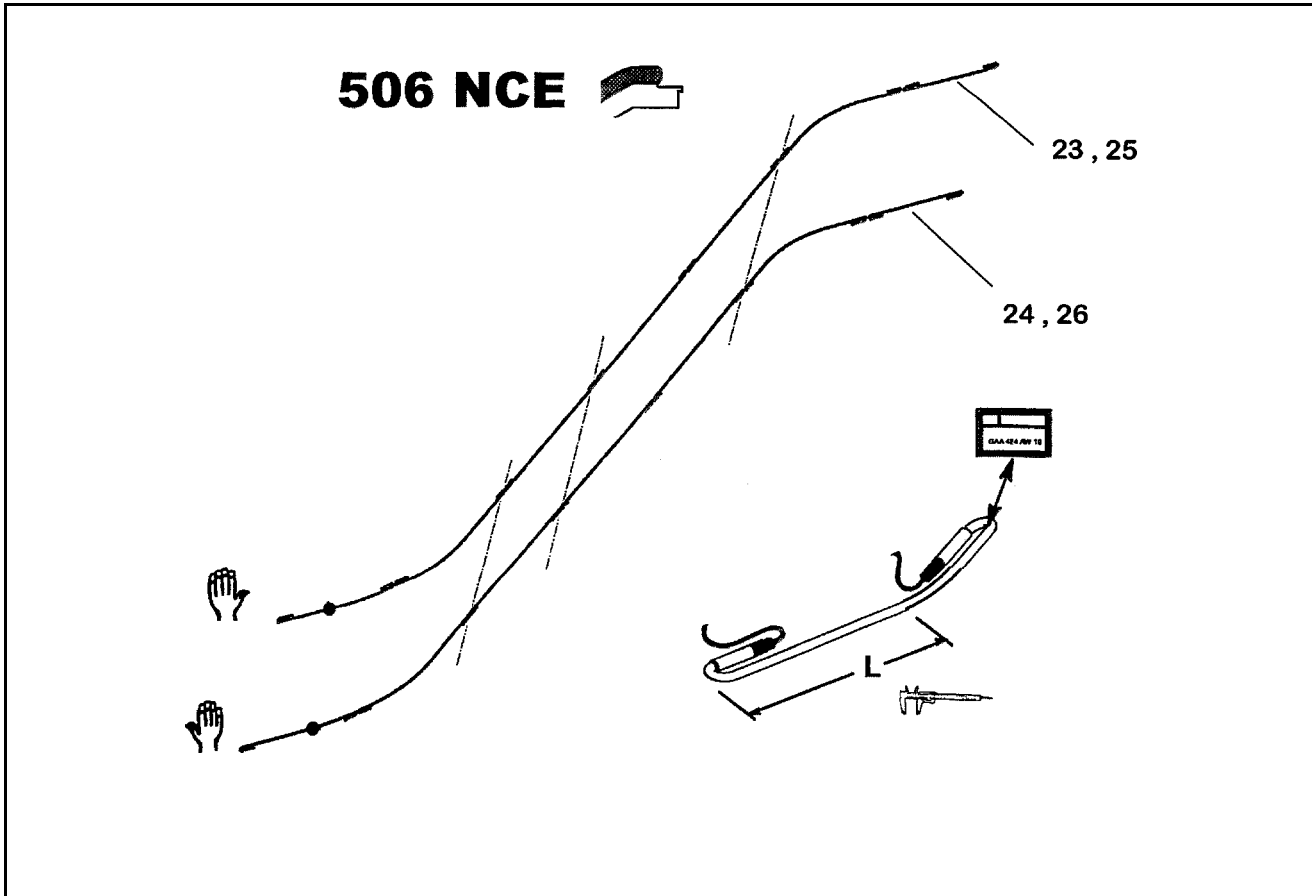

GAA26427F		
REF. No.	PART No.	DESCRIPTION
21	GAA424AW1 GBA424AW1 GCA424AW1	Fluorescent Lamp, , L = 500 mm, 35°, Code EN 115,
	GCA424AW500	30°, Region APA, (two flat steps)
22	GAA424AW3 GBA424AW3 GCA424AW3	Fluorescent Lamp, , L = 725 mm, 30°, Code JIS, (1.4 steps)
	GCA424AW725	

**Trav-O-Lator® 606 NCT, Escalator 513
NPE-SR, 506 NCE: Skirt Panel Lighting**

57-GAA26427F







		GAA26427F
REF. No.	PART No.	DESCRIPTION
23	GAA424AW2 GBA424AW2 GCA424AW2	Fluorescent Lamp,  , L = 550 mm, 30°, Region NAA,
	GCA424AW550	 (two flat steps)
24	GAA424AW4 GBA424AW4 GCA424AW4	Fluorescent Lamp,  , L = 800 mm, 30°, Region NAA,
	GCA424AW800	 (two flat steps)
25	GAA424AW7 GBA424AW7 GCA424AW7	Fluorescent Lamp,  , L = 975 mm, 30°, Region NAA,
	GCA424AW975	 (three flat steps)
26	GAA424AW50 GBA424AW50 GCA424AW50	Fluorescent Lamp,  , L = 1200 mm, 30°, Region NAA,
	GCA424AW1200	 (three flat steps)

57-GAA26427F

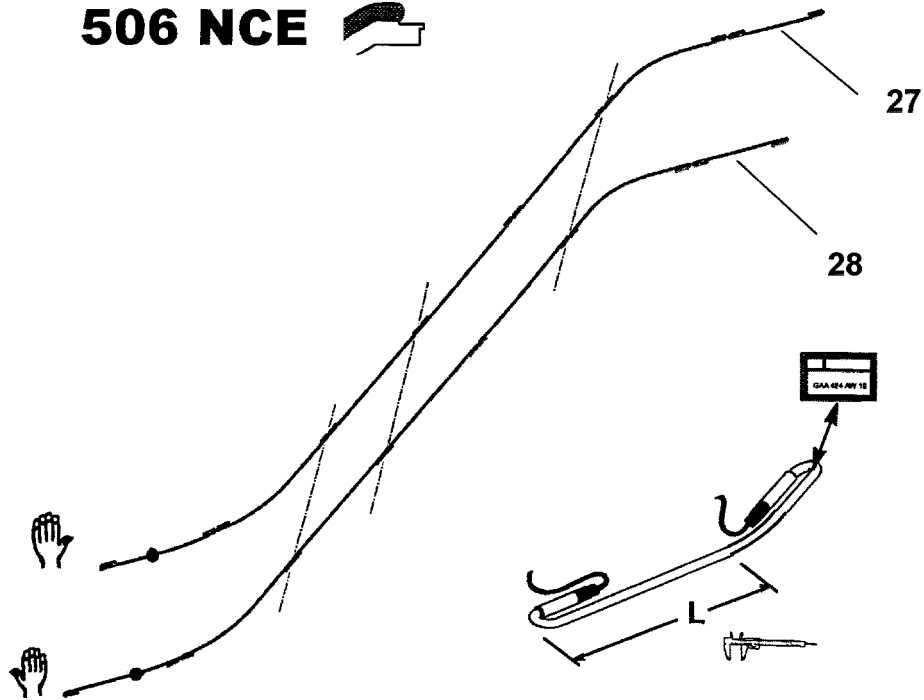
**Trav-O-Lator® 606 NCT, Escalator 513
NPE-SR, 506 NCE: Skirt Panel Lighting**

506 NCE 





GAA26427F		
REF. No.	PART No.	DESCRIPTION
27	GAA424AW5 GBA424AW5 GCA424AW5	Fluorescent Lamp,  , L = 900 mm, 35°, Code EN 115,
	GCA424AW900	30°, Region APA,  (three flat steps)
28	GAA424AW8 GBA424AW8 GCA424AW8	Fluorescent Lamp,  , L = 1125 mm, 35°, Code EN 115,
	GCA424AW1125	30°, Region APA,  (three flat steps)

**Trav-O-Lator® 606 NCT, Escalator 513
NPE-SR, 506 NCE: Skirt Panel Lighting**

57-GAA26427F

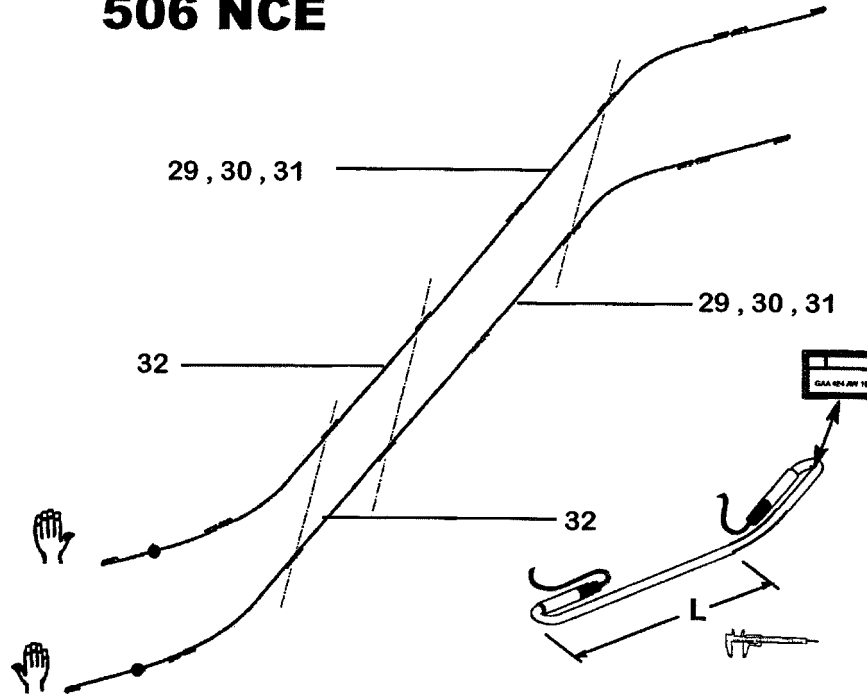
506 NCE









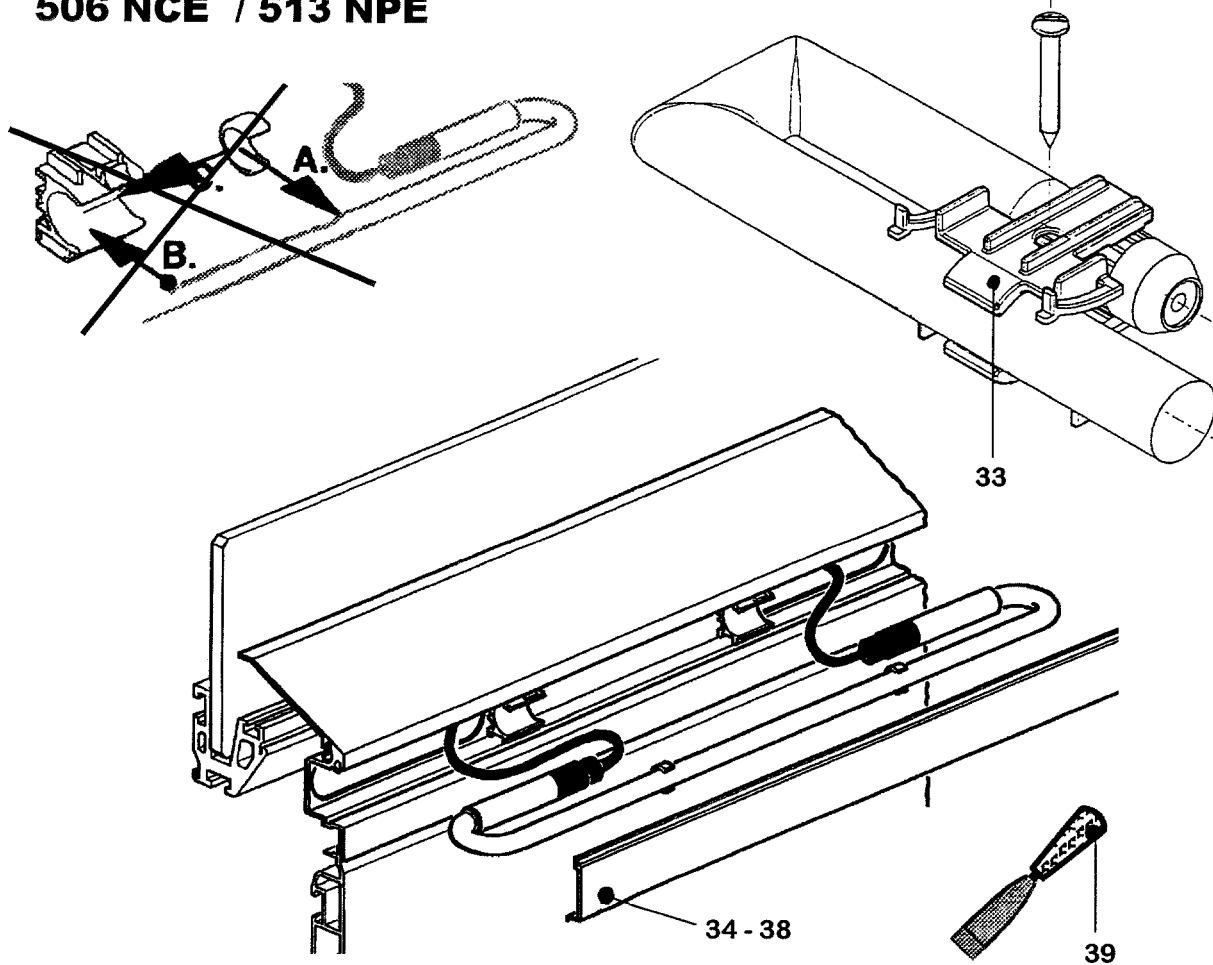

GAA26427F		
REF. No.	PART No.	DESCRIPTION
29	GAA424AT1 GBA424AT1 GCA424AT1	Fluorescent Lamp, L = 1470 mm
30	GAA424AT3 GBA424AT3 GCA424AT3	Fluorescent Lamp, L = 1150 mm
31	GAA424AT4 GBA424AT4 GCA424AT4	Fluorescent Lamp, L = 970 mm
32	GAA424AT-V1 GBA424AT-V1 GCA424AT-V1	Fluorescent Lamp, L = 
	GCA424AW---	Fluorescent Lamp, L =  (min. 500 mm +25 + 25 → max. 1470 mm)

57-GAA26427F

**Trav-O-Lator® 606 NCT, Escalator 513
NPE-SR, 506 NCE: Skirt Panel Lighting**

506 NCE / 513 NPE



GAA26427F		
REF. No.	PART No.	DESCRIPTION
33	GAA180AYZ1 GBA180AYZ2 GCA180BDA1	Holder Reducer
	GAA180BSM1	Holder
34	GAA50AGP4 GBA50AGP1	Diffusor (incline section)
35	GAA402BMM1 GBA402BMM1	Diffusor,  
36	GAA402BMM2 GBA402BMM2	Diffusor,  
37	GAA4402BML1 GBA402BML1	Diffusor,  
38	GAA4402BML2 GBA402BML2	Diffusor,  
39	WZ5385	Tool to Clip out Diffusor at Inner Decking

**Trav-O-Lator® 606 NCT, Escalator 513
NPE-SR, 506 NCE: Skirt Panel Lighting**

57-GAA26427F

606 NCT TYPE INCLINE

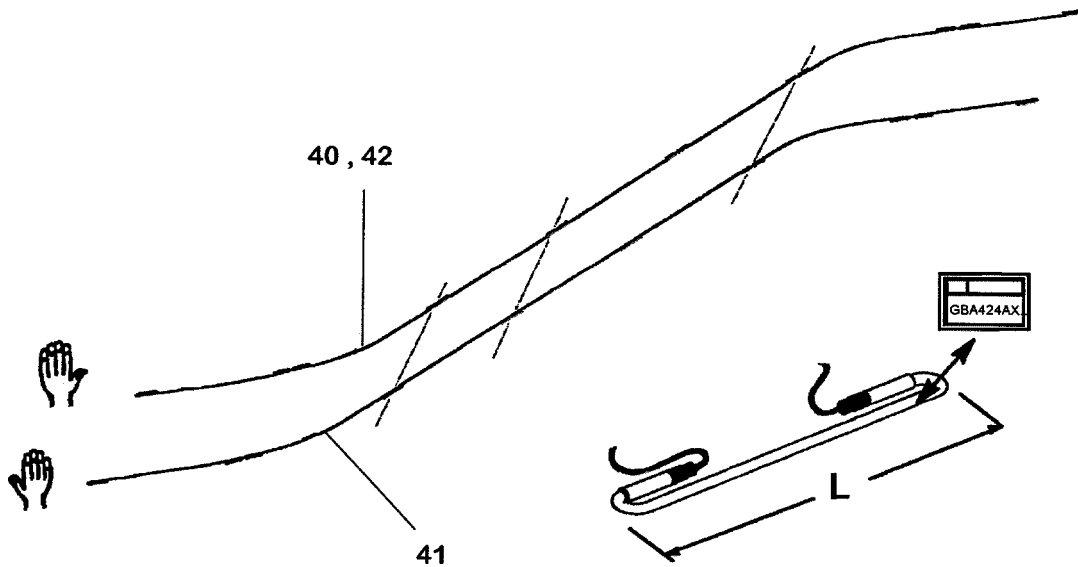





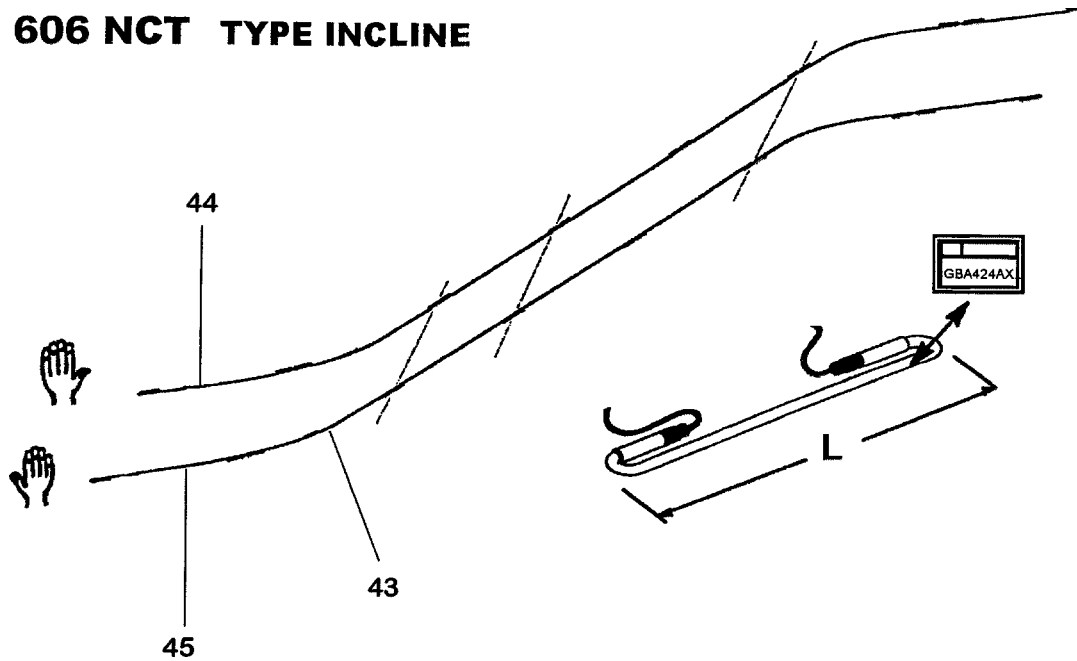

GAA26427F		
REF. No.	PART No.	DESCRIPTION
40	GAA424AX5 GBA424AX5 GCA424AX5	Fluorescent Lamp, , 10°,
41	GAA424AX6 GBA424AX6 GCA424AX6	Fluorescent Lamp, , 10°,
42	GAA424AX7 GBA424AX7 GCA424AX7	Fluorescent Lamp, , 12°,

57-GAA26427F

**Trav-O-Lator® 606 NCT, Escalator 513
NPE-SR, 506 NCE: Skirt Panel Lighting**

606 NCT TYPE INCLINE







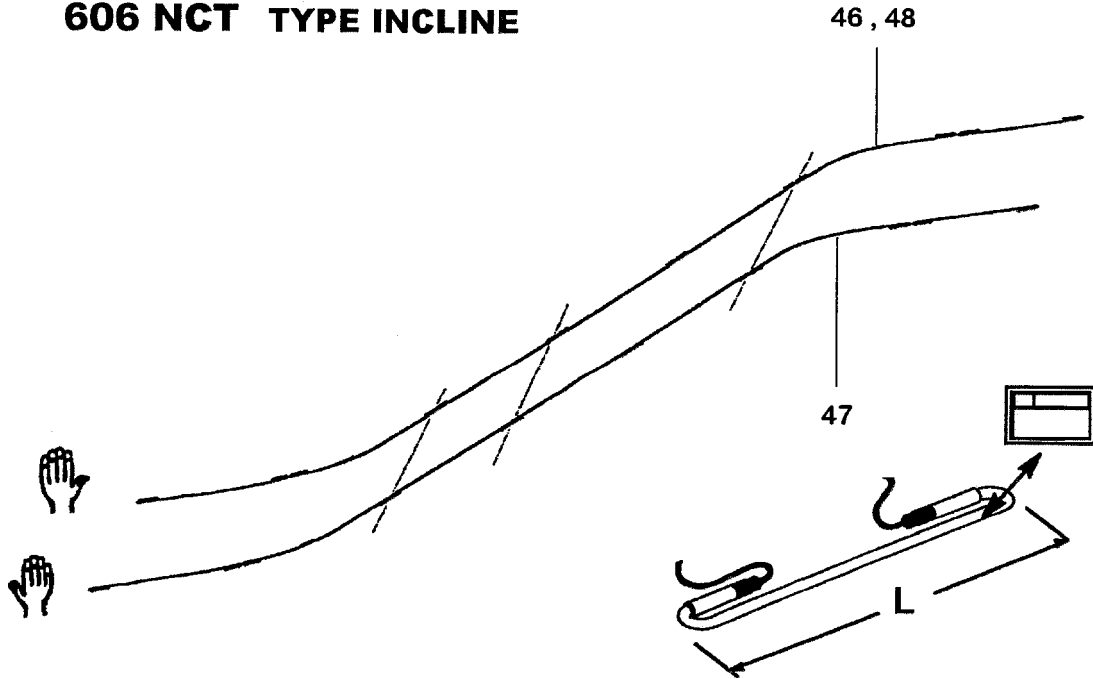

GAA26427F		
REF. No.	PART No.	DESCRIPTION
43	GAA424AX8 GBA424AX8 GCA424AX8	Fluorescent Lamp,  , 12°, 
44	GAA424AW51 GBA424AW51 GCA424AW51 GCA424AW1225	Fluorescent Lamp,  , L = 1225 mm, 
45	GAA424AW52 GBA424AW52 GCA424AW52 GCA424AW1000	Fluorescent Lamp,  , L = 1000 mm, 

**Trav-O-Lator® 606 NCT, Escalator 513
NPE-SR, 506 NCE: Skirt Panel Lighting**

57-GAA26427F

606 NCT TYPE INCLINE







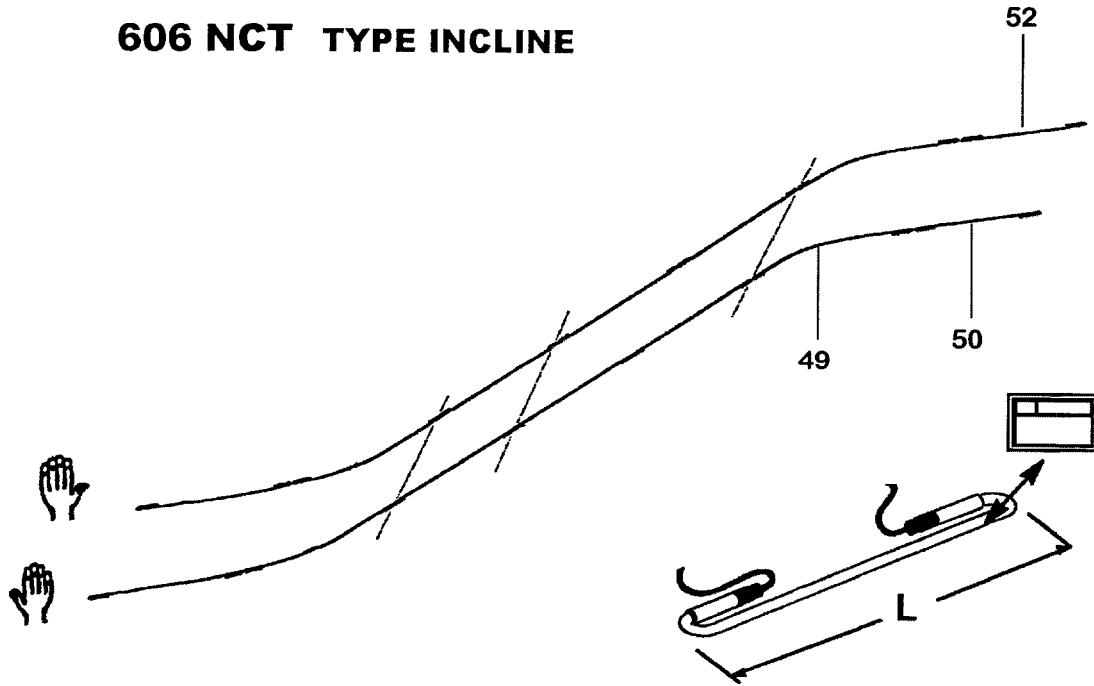

GAA26427F		
REF. No.	PART No.	DESCRIPTION
46	GAA424AX5 GBA424AX5 GCA424AX5	Fluorescent Lamp,  , 10°, 
47	GAA424AX6 GBA424AX6 GCA424AX6	Fluorescent Lamp,  , 10°, 
48	GAA424AX7 GBA424AX7 GCA424AX7	Fluorescent Lamp,  , 12°, 

57-GAA26427F

**Trav-O-Lator® 606 NCT, Escalator 513
NPE-SR, 506 NCE: Skirt Panel Lighting**

606 NCT TYPE INCLINE





GAA26427F		
REF. No.	PART No.	DESCRIPTION
49	GAA424AX8 GBA424AX8 GCA424AX8	Fluorescent Lamp,  , 12°, 
50	GAA424AW51 GBA424AW51 GCA424AW51 GCA424AW1225	Fluorescent Lamp,  , L = 1225 mm, 
52	GAA424AW52 GBA424AW52 GCA424AW52 GCA424AW1000	Fluorescent Lamp,  , L = 1000 mm, 

**Trav-O-Lator® 606 NCT, Escalator 513
NPE-SR, 506NCE: Skirt Panel Lighting**

57-GAA26427F

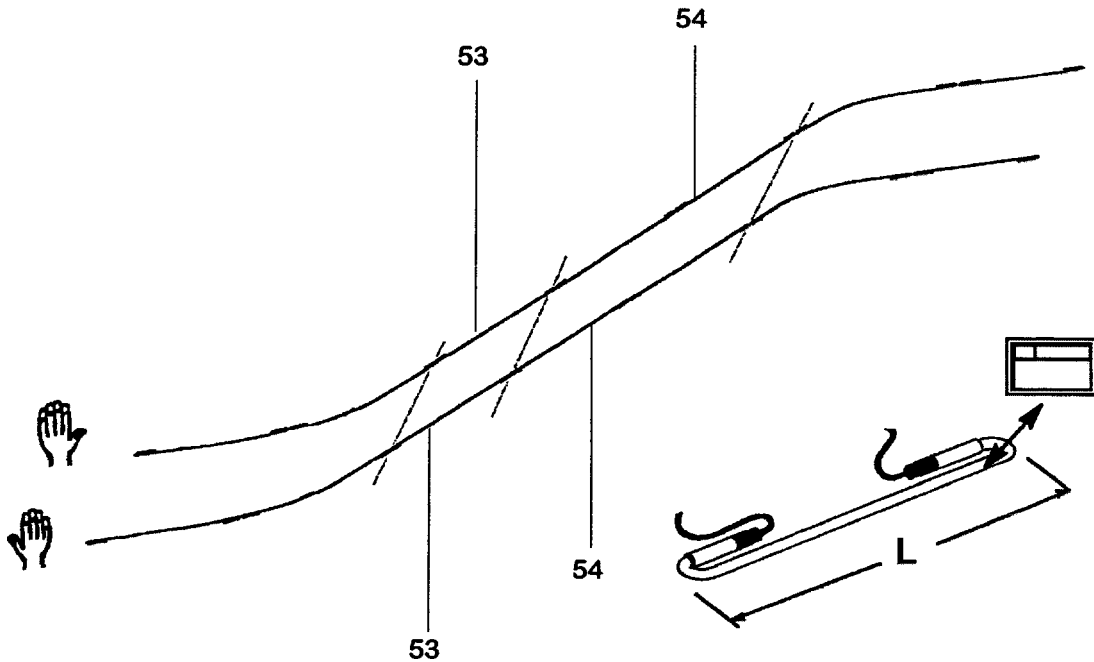
606 NCT TYPE INCLINE







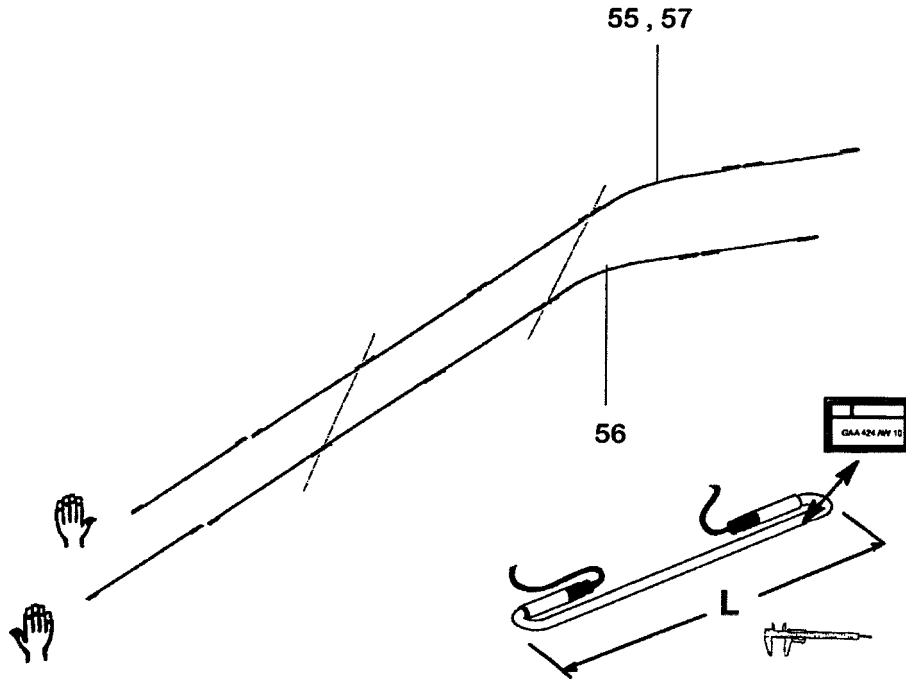

GAA26427F		
REF. No.	PART No.	DESCRIPTION
53	GAA424AW-V GBA424AW-V GCA424AT-V	Fluorescent Lamp, L = 500-1470 mm
	GCA424AW---	Fluorescent Lamp, L =  (min. 500 mm +25 + 25 → max. 1470 mm)
54	GAA424AT1 GBA424AT1 GCA424AT1	Fluorescent Lamp, L = 1470 mm
	GCA424AT2	Fluorescent Lamp, L = 1170 mm
	GCA424AT3	Fluorescent Lamp, L = 1150 mm

57-GAA26427F

**Trav-O-Lator® 606 NCT, Escalator 513
NPE-SR, 506 NCE: Skirt Panel Lighting**

606 NCT TYPE COMPACT







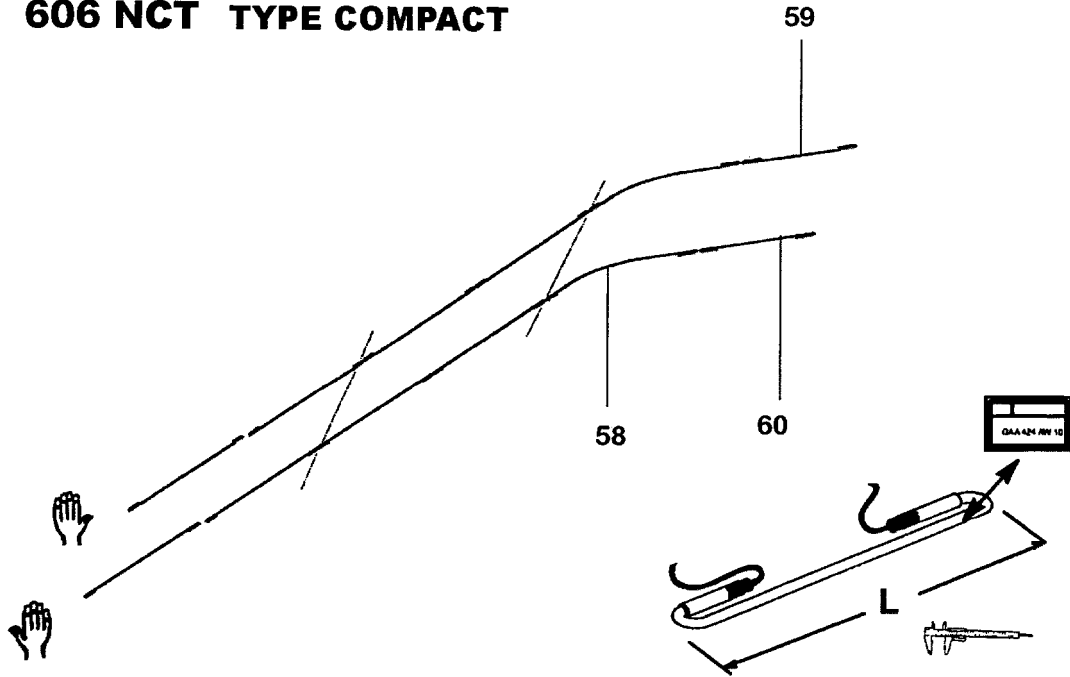

GAA26427F		
REF. No.	PART No.	DESCRIPTION
55	GAA424AX5 GBA424AX5 GCA424AX5	Fluorescent Lamp,  , 10°, 
56	GAA424AX6 GBA424AX6 GCA424AX6	Fluorescent Lamp,  , 10°, 
57	GAA424AX7 GBA424AX7 GCA424AX7	Fluorescent Lamp,  , 12°, 

**Trav-O-Lator® 606 NCT, Escalator 513
NPE-SR, 506 NCE: Skirt Panel Lighting**

57-GAA26427F

606 NCT TYPE COMPACT











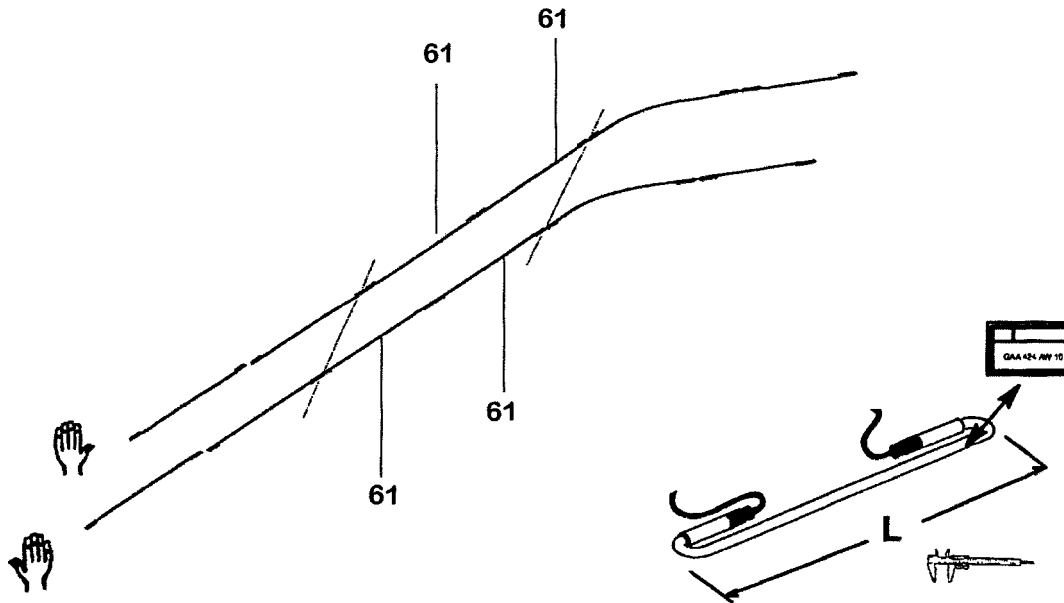

GAA26427F		
REF. No.	PART No.	DESCRIPTION
58	GAA424AX8 GBA424AX8 GCA424AX8	Fluorescent Lamp,  , 12°, 
59	GAA424AW54 GBA424AW54 GCA424AW54 GCA424AW600	Fluorescent Lamp,  , L = 600 mm, 
60	GAA424AW53 GBA424AW53 GCA424AW53 GCA424AW825	Fluorescent Lamp,  , L = 825 mm, 

57-GAA26427F

**Trav-O-Lator® 606 NCT, Escalator 513
NPE-SR, 506 NCE: Skirt Panel Lighting**

606 NCT TYPE COMPACT



GAA26427F		
REF. No.	PART No.	DESCRIPTION
61	GAA424AT1 GBA424AT1 GCA424AT1	Fluorescent Lamp,  +  , L = 1470 mm
	GCA424AT2	Fluorescent Lamp,  +  , L = 1170 mm
	GCA424AT3	Fluorescent Lamp,  +  , L = 1150 mm
	GAA424AT-V1 GCA424AW---	Fluorescent Lamp,  +  , L =  (min. 500 mm +25 + 25 → max. 1470 mm)

**Trav-O-Lator® 606 NCT, Escalator 513
NPE-SR, 506 NCE: Skirt Panel Lighting**

57-GAA26427F

606 NCT TYPE COMPACT

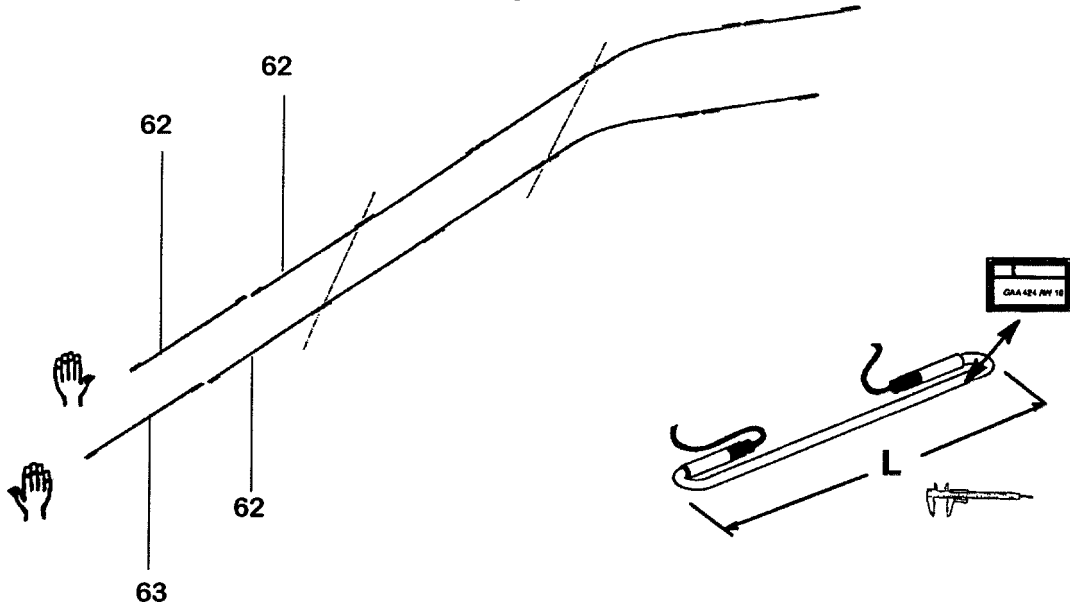

GAA26427F		
REF. No.	PART No.	DESCRIPTION
62	GAA424AW6 GBA424AW6 GCA424AW6	Fluorescent Lamp, L = 950 mm
	GCA424AW950	
63	GAA424AW55 GBA424AW55 GCA424AW55	Fluorescent Lamp, L = 700 mm
	GCA424AW700	

57-GAA26427F

**Trav-O-Lator® 606 NCT, Escalator 513
NPE-SR, 506 NCE: Skirt Panel Lighting**

606 NCT TYPE HORIZONTAL

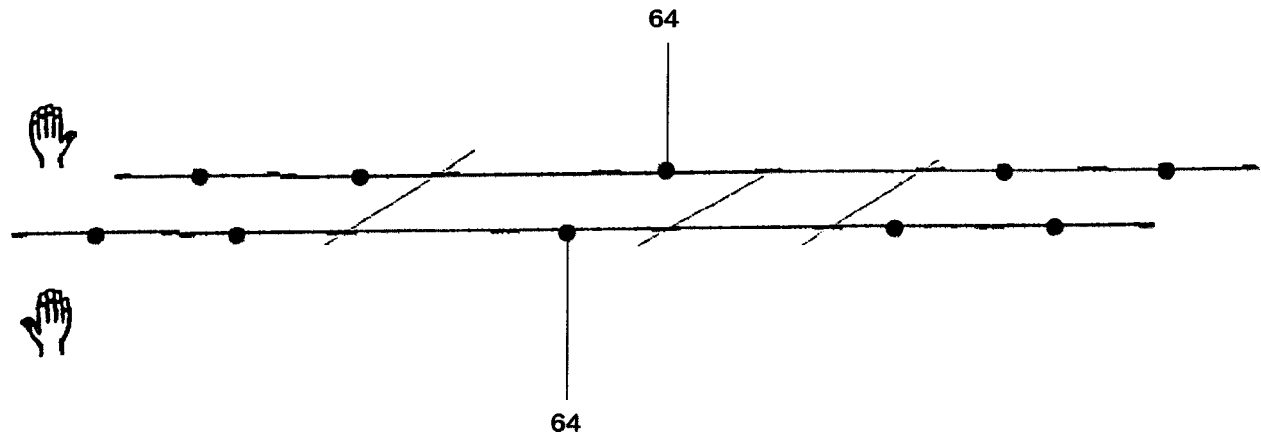

GAA26427F		
REF. No.	PART No.	DESCRIPTION
64	GAA424AT1 GBA424AT1 GCA424AT1	Fluorescent Lamp, + , L = 1470 mm
	GCA424AT2	Fluorescent Lamp, + , L = 1170 mm
	GCA424AT3	Fluorescent Lamp, + , L = 1150 mm
	GAA424AT-V4 GCA424AW---	Fluorescent Lamp, + , L = (min. 500 mm +25 + 25 → max. 1470 mm)

**Trav-O-Lator® 606 NCT, Escalator 513
NPE-SR, 506 NCE: Skirt Panel Lighting**

57-GAA26427F

606 NCT TYPE HORIZONTAL

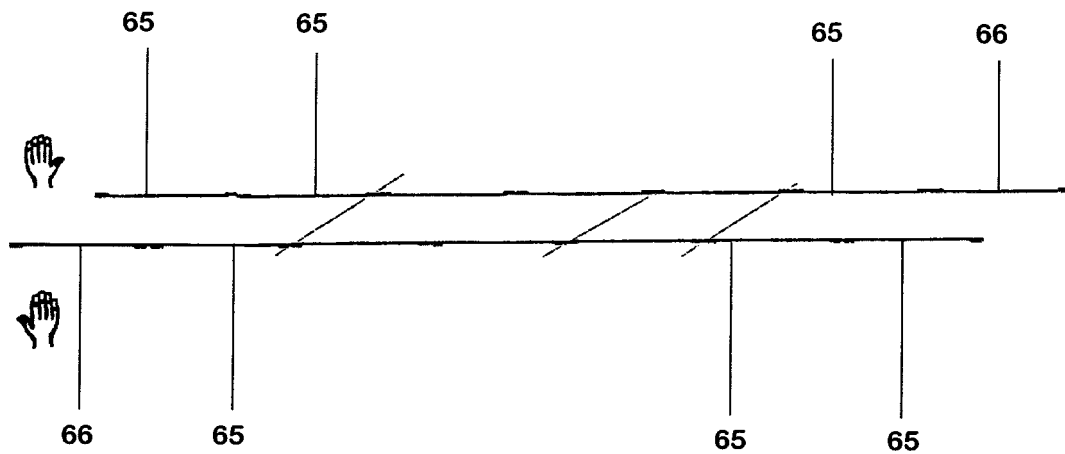

GAA26427F		
REF. No.	PART No.	DESCRIPTION
65	GAA424AW6 GBA424AW6 GCA424AW6	Fluorescent Lamp, L = 950 mm
	GCA424AW950	
66	GAA424AW55 GBA424AW55 GCA424AW55	Fluorescent Lamp, L = 700 mm
	GCA424AW700	

57-GAA26427F

**Trav-O-Lator® 606 NCT, Escalator 513
NPE-SR, 506 NCE: Skirt Panel Lighting**

606 NCT

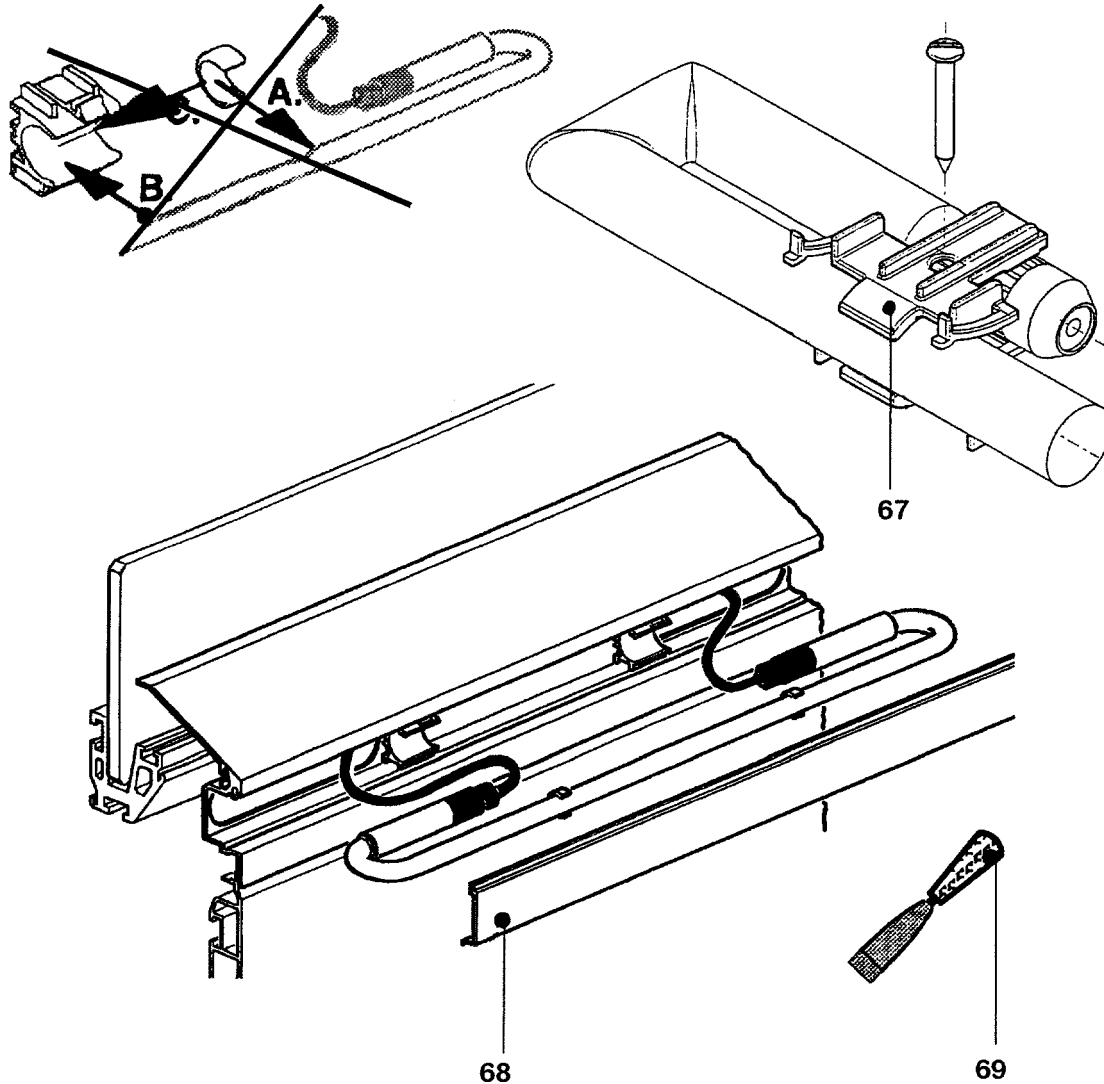









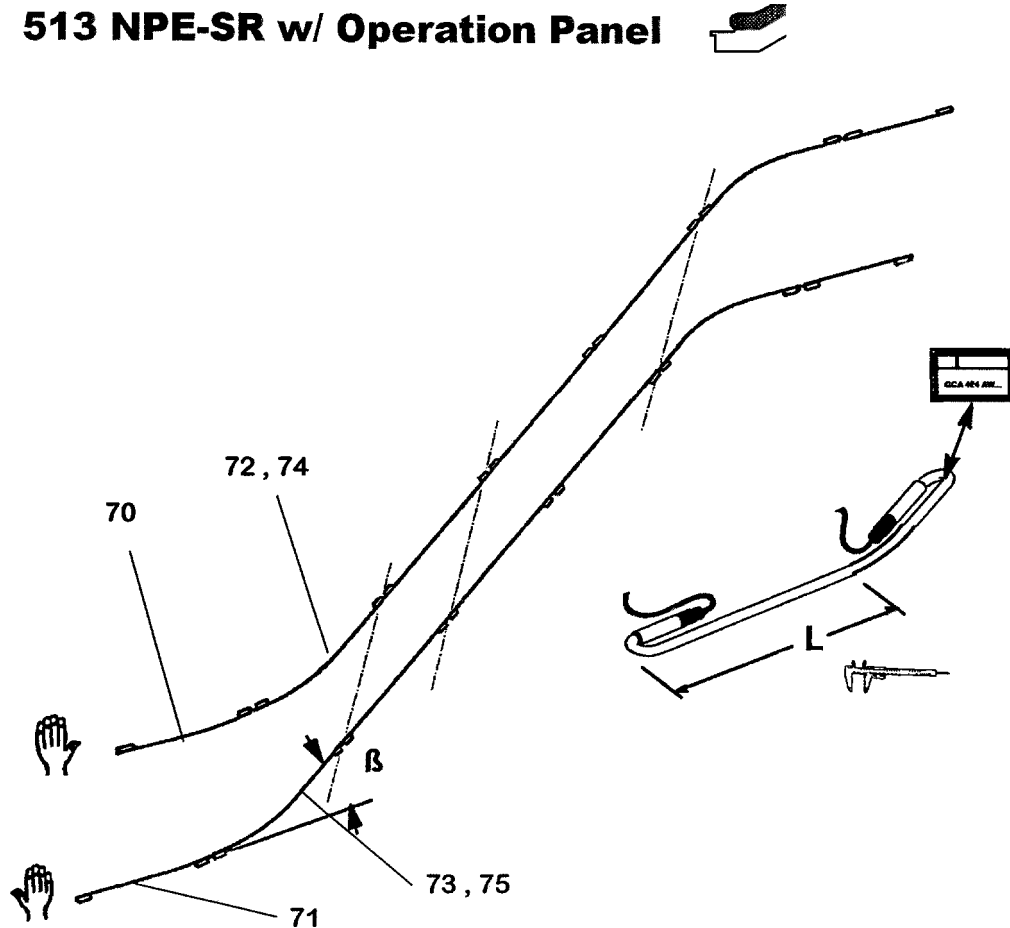



GAA26427F		
REF. No.	PART No.	DESCRIPTION
67	GAA180AYZ1 GBA180AYZ2 GCA180BDA1	Holder Reducer
	GAA180BSM1	Holder
68	GAA50AGP4 GBA50AGP1	Diffusor
69	WZ5385	Tool to Clip out Diffusor at Inner Decking

**Trav-O-Lator® 606 NCT, Escalator 513
NPE-SR, 506 NCE: Skirt Panel Lighting**

57-GAA26427F

513 NPE-SR w/ Operation Panel



GAA26427F		
REF. No.	PART No.	DESCRIPTION
70	GCA424AW20	Fluorescent Lamp,  , L = 762 mm,  , 30°
71	GCA424AW21	Fluorescent Lamp,  , L = 762 mm,  , 27.3°
72	GCA424AW60	Fluorescent Lamp,  , L = 572 mm,  , 30°
73	GCA424AW61	Fluorescent Lamp,  , L = 331 mm,  , 30°
74	GCA424AW62	Fluorescent Lamp,  , L = 972 mm,  , 30°
75	GCA424AW63	Fluorescent Lamp,  , L = 731 mm,  , 30°

57-GAA26427F

**Trav-O-Lator® 606 NCT, Escalator 513
NPE-SR, 506 NCE: Skirt Panel Lighting**

513 NPE-SR w/ Operation Panel

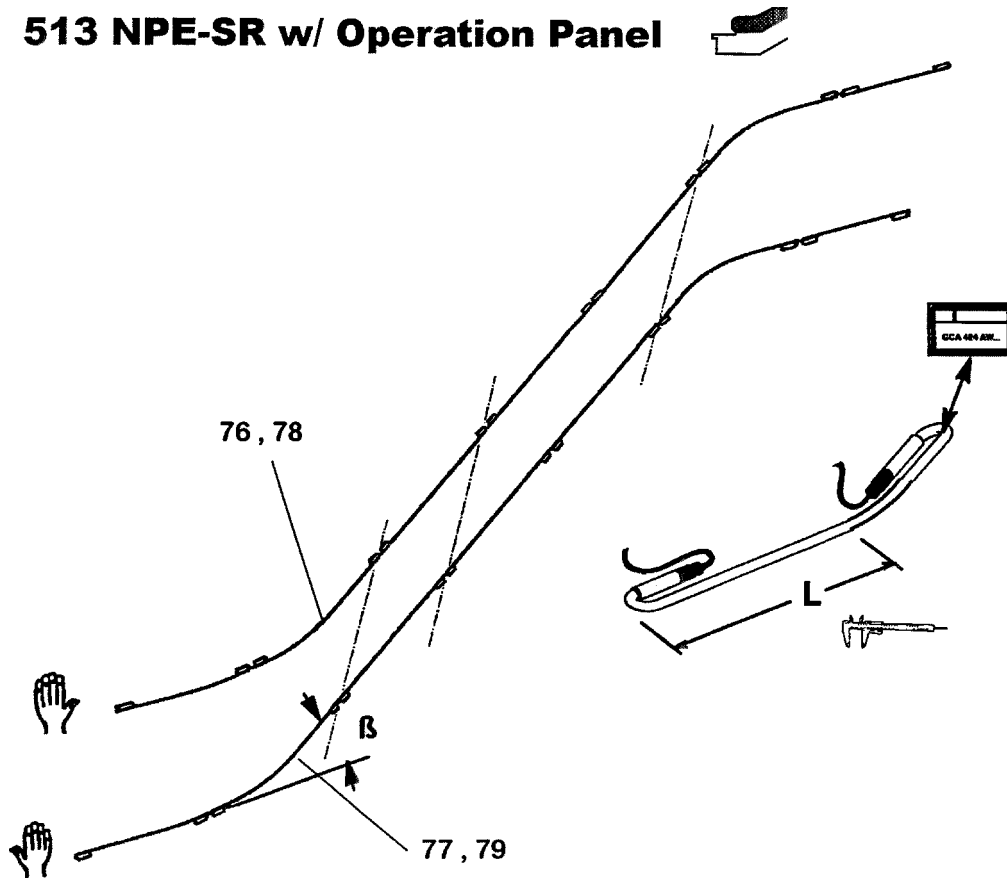







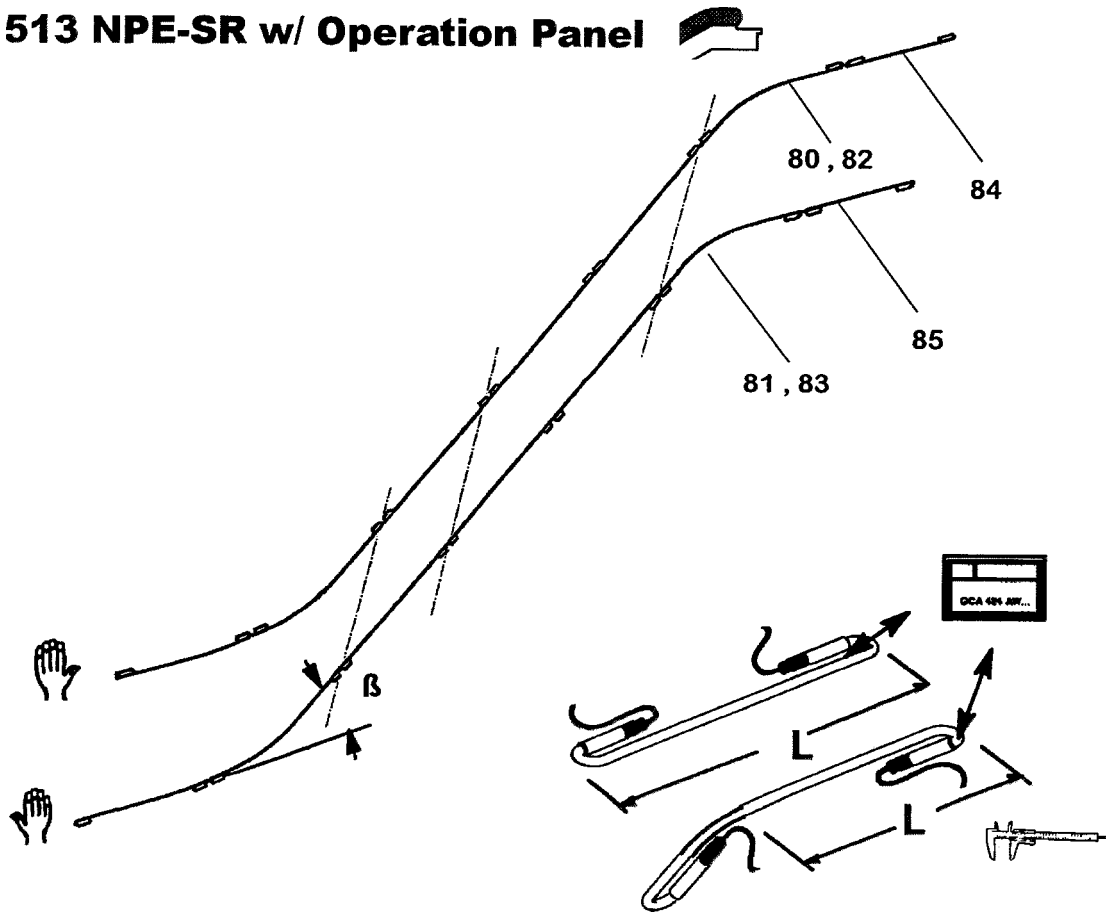

GAA26427F		
REF. No.	PART No.	DESCRIPTION
76	GCA424AW26	Fluorescent Lamp, , L = 611 mm, , 27.3°
77	GCA424AW27	Fluorescent Lamp, , L = 370 mm, , 27.3°
78	GCA424AW28	Fluorescent Lamp, , L = 1011 mm, , 27.3°
79	GCA424AW29	Fluorescent Lamp, , L = 770 mm, , 27.3°

**Trav-O-Lator® 606 NCT, Escalator 513
NPE-SR, 506 NCE: Skirt Panel Lighting**

57-GAA26427F

513 NPE-SR w/ Operation Panel



GAA26427F		
REF. No.	PART No.	DESCRIPTION
80	GCA424AW36	Fluorescent Lamp,  , L = 291 mm, 27.3°
81	GCA424AW37	Fluorescent Lamp,  , L = 291 mm, 27.3°
82	GCA424AW30	Fluorescent Lamp,  , L = 315 mm, 30°
83	GCA424AW31	Fluorescent Lamp,  , L = 315 mm, 30°
84	GCA424AW54 GCA424AW600	Fluorescent Lamp,  , L = 600 mm,  , 30°
85	GCA424AW29 GCA424AW825	Fluorescent Lamp,  , L = 825 mm,  , 27.3°







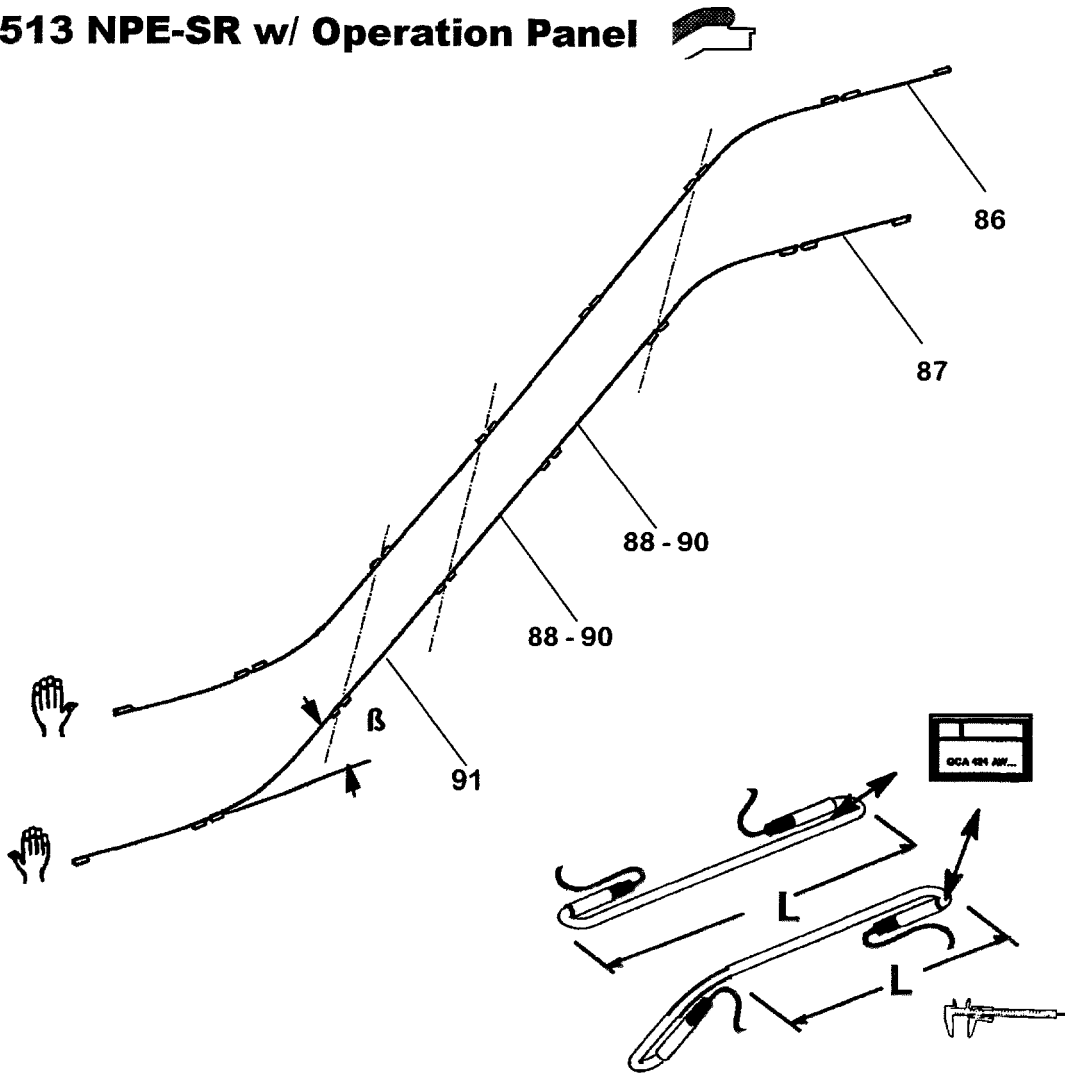





57-GAA26427F

**Trav-O-Lator® 606 NCT, Escalator 513
NPE-SR, 506 NCE: Skirt Panel Lighting**

513 NPE-SR w/ Operation Panel











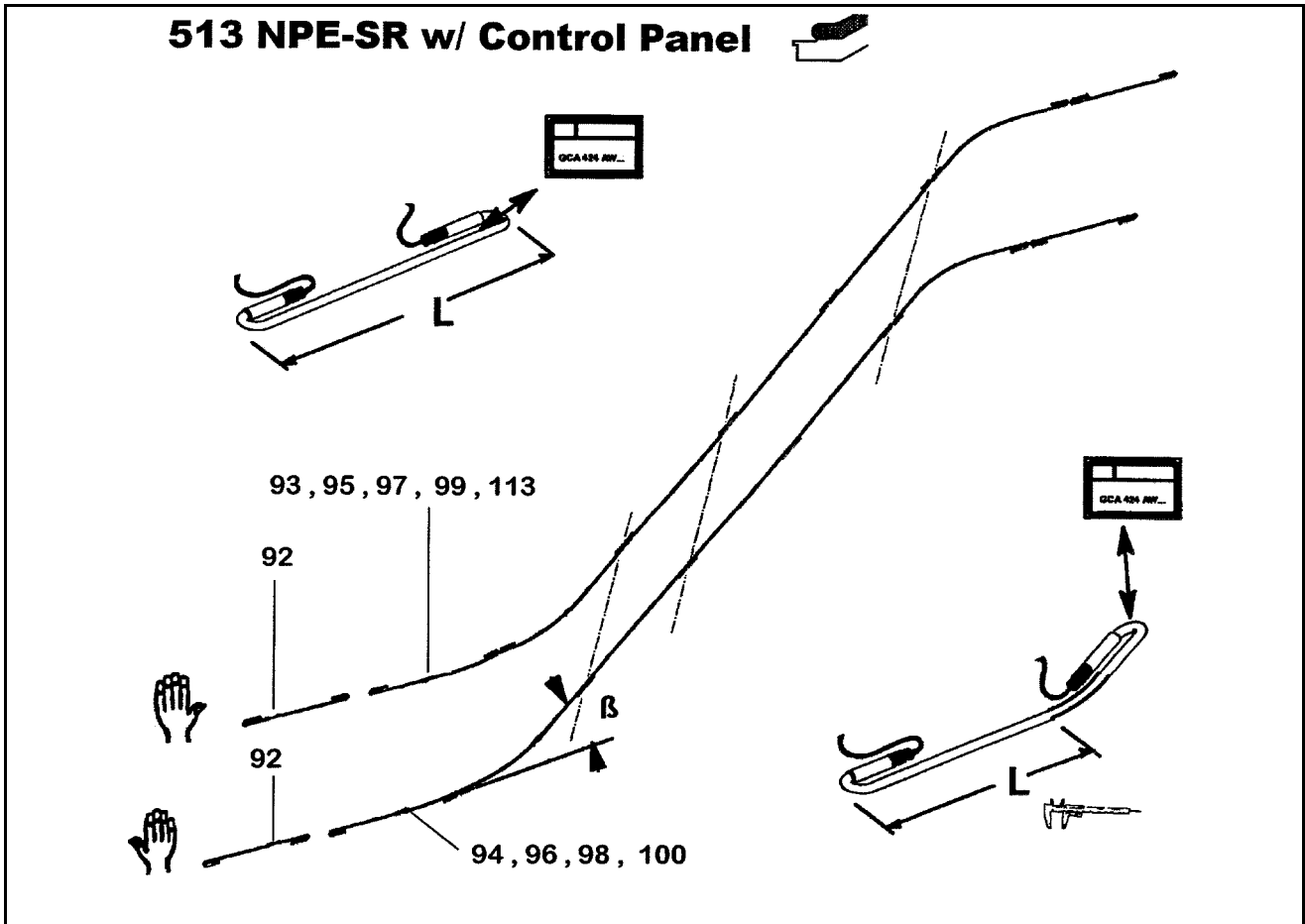









GAA26427F

REF. No.	PART No.	DESCRIPTION
86	GCA424AW52 GCA424AW1000	Fluorescent Lamp,  , L = 1000 mm,  , 27.3° / 30°
87	GCA424AW54 GCA424AW1225	Fluorescent Lamp,  , L = 1225 mm,  , 27.3° / 30°
88	GCA424AT1	Fluorescent Lamp,  +  , L = 1470 mm
89	GCA424AT3	Fluorescent Lamp,  +  , L = 1150 mm
90	GCA424AT4	Fluorescent Lamp,  +  , L = 970 mm
91	GCA424AT-V4 GCA424AW---	Fluorescent Lamp,  +  , L =  (min. 500 mm +25 + 25 → max. 1470 mm)

**Trav-O-Lator® 606 NCT, Escalator 513
NPE-SR, 506 NCE: Skirt Panel Lighting**

57-GAA26427F



GAA26427F		
REF. No.	PART No.	DESCRIPTION
92	GCA424AW4 GCA424AW500	Fluorescent Lamp, L = 500 mm,  , 27.3° / 30°
93	GCA424AW101	Fluorescent Lamp,  , L = 68 mm,  , 27.3°
94	GCA424AW102	Fluorescent Lamp,  , L = 68 mm,  , 27.3°
95	GCA424AW103	Fluorescent Lamp,  , L = 468 mm,  , 27.3°
96	GCA424AW104	Fluorescent Lamp,  , L = 468 mm,  , 27.3°
97	GCA424AW105	Fluorescent Lamp,  , L = 869 mm,  , 27.3°
98	GCA424AW106	Fluorescent Lamp,  , L = 869 mm,  , 27.3°
99	GCA424AW107	Fluorescent Lamp,  , L = 178 mm,  , 27.3°
100	GCA424AW108	Fluorescent Lamp,  , L = 178 mm,  , 27.3°

57-GAA26427F

Trav-O-Lator® 606 NCT, Escalator 513 NPE-SR, 506 NCE: Skirt Panel Lighting

513 NPE-SR w/ Control Panel

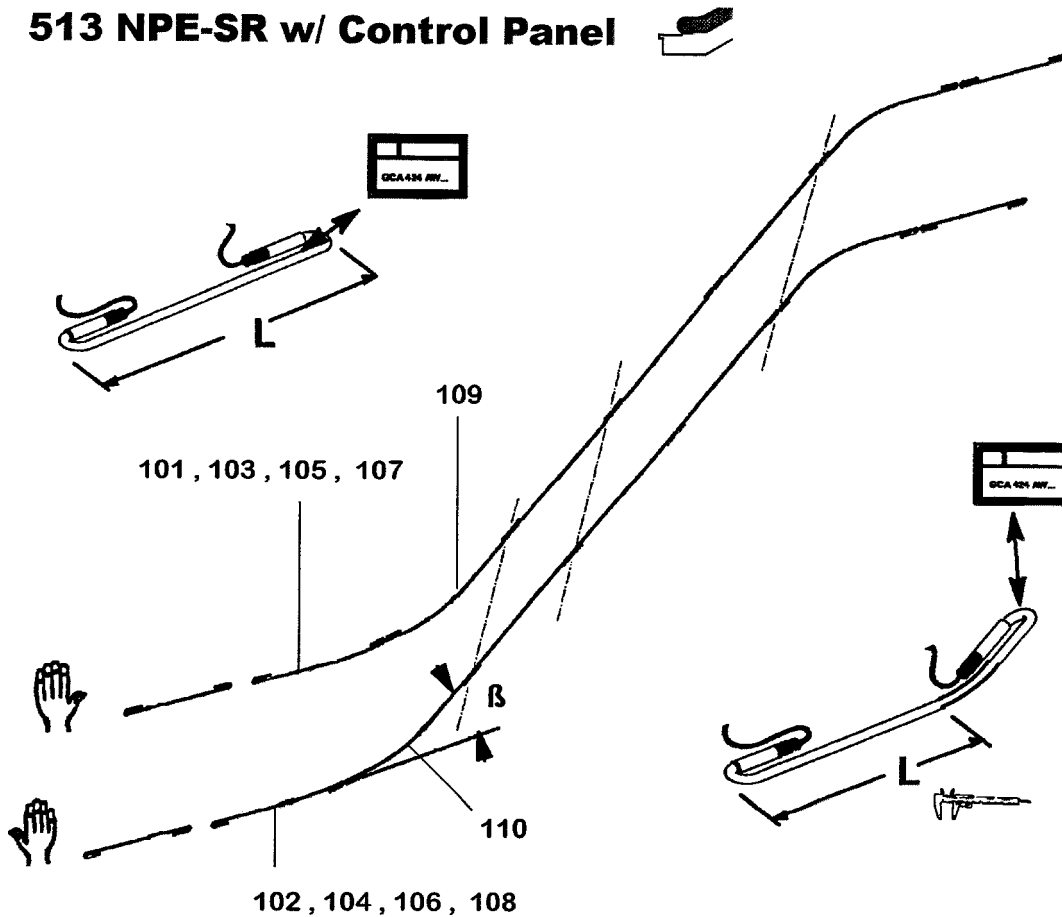

GAA26427F

REF. No.	PART No.	DESCRIPTION
101	GCA424AW109	Fluorescent Lamp, , L = 30 mm, , 30°
102	GCA424AW110	Fluorescent Lamp, , L = 30 mm, , 30°
103	GCA424AW111	Fluorescent Lamp, , L = 430 mm, , 30°
104	GCA424AW112	Fluorescent Lamp, , L = 430 mm, , 30°
105	GCA424AW113	Fluorescent Lamp, , L = 831 mm, , 30°
106	GCA424AW114	Fluorescent Lamp, , L = 831 mm, , 30°
107	GCA424AW115	Fluorescent Lamp, , L = 715 mm, , 30°
108	GCA424AW116	Fluorescent Lamp, , L = 715 mm, , 30°
109	GCA424AW121	Fluorescent Lamp, , L = 765 mm, 27.3° / 30°
110	GCA424AW122	Fluorescent Lamp, , L = 765 mm, 27.3° / 30°







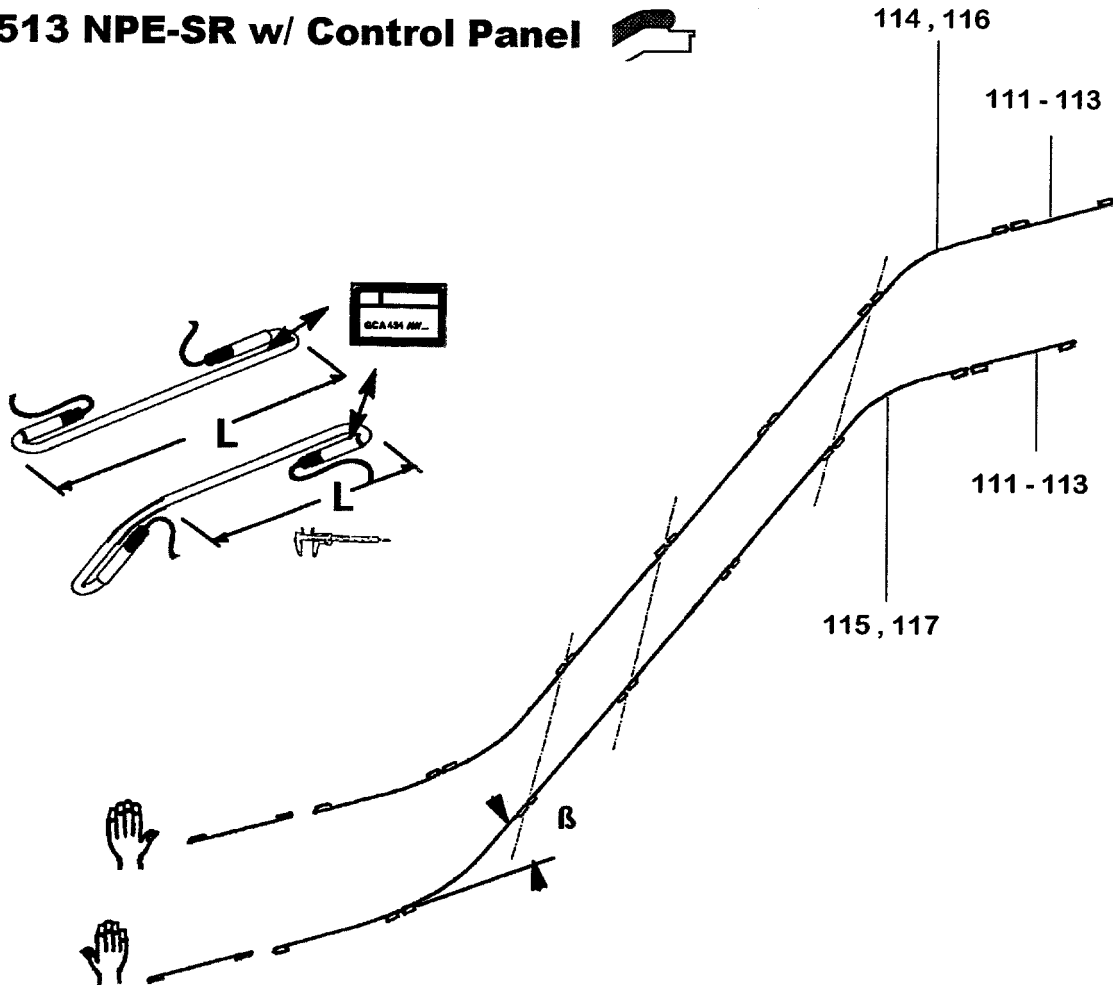











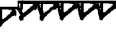

Trav-O-Lator® 606 NCT, Escalator 513 NPE-SR, 506 NCE: Skirt Panel Lighting

57-GAA26427F

513 NPE-SR w/ Control Panel



GAA26427F

REF. No.	PART No.	DESCRIPTION
111	GCA424AW4 GCA424AW500	Fluorescent Lamp,  +  , L = 500 mm,  , 27.3° / 30°
112	GCA424AW5 GCA424AW900	Fluorescent Lamp,  +  , L = 900 mm,  , 27.3° / 30°
113	GCA424AW1306 GCA424AW1300	Fluorescent Lamp,  +  , L = 900 mm,  , 27.3° / 30°
114	GCA424AW131	Fluorescent Lamp,  , L = 570 mm,  , 27.3°
115	GCA424AW132	Fluorescent Lamp,  , L = 570 mm,  , 27.3°
116	GCA424AW133	Fluorescent Lamp,  , L = 495 mm,  ,  ,  , 27.3°
117	GCA424AW134	Fluorescent Lamp,  , L = 495 mm,  ,  ,  , 27.3°

57-GAA26427F

Trav-O-Lator® 606 NCT, Escalator 513 NPE-SR, 506 NCE: Skirt Panel Lighting

513 NPE-SR w/ Control Panel

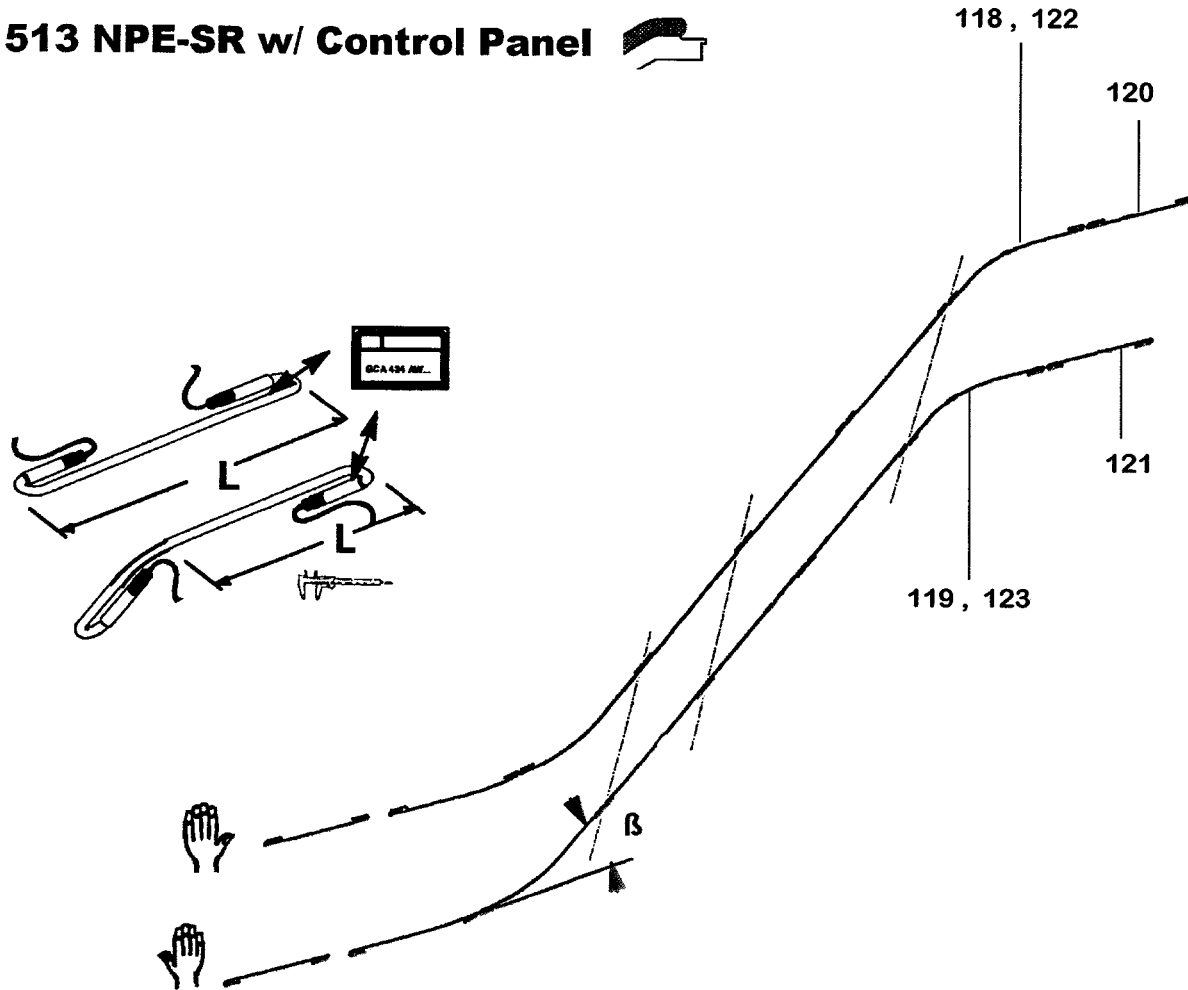

GAA26427F		
REF. No.	PART No.	DESCRIPTION
118	GCA424AW135	Fluorescent Lamp, , , 30°
119	GCA424AW136	Fluorescent Lamp, , , 30°
120	GCA424AW137	Fluorescent Lamp, , L = 629 mm, , 30°
121	GCA424AW138	Fluorescent Lamp, , L = 629 mm, , 30°
122	GCA424AW139	Fluorescent Lamp, , L = 513 mm, , , , 30°
123	GCA424AW140	Fluorescent Lamp, , L = 513 mm, , , , 30°

**Trav-O-Lator® 606 NCT, Escalator 513
NPE-SR, 506 NCE: Skirt Panel Lighting**

57-GAA26427F

513 NPE-SR w/ Control Panel

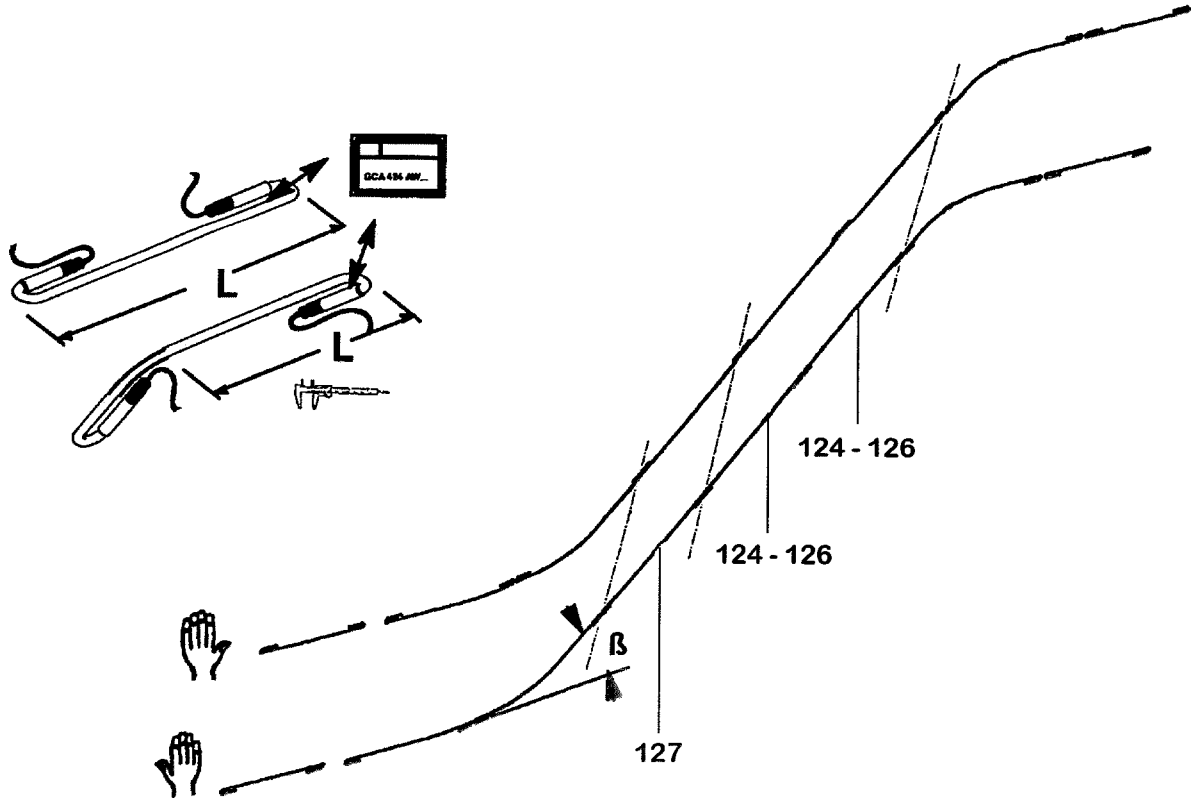

GAA26427F		
REF. No.	PART No.	DESCRIPTION
124	GCA424AT1	Fluorescent Lamp, + , L = 1470 mm
125	GCA424AT3	Fluorescent Lamp, + , L = 1150 mm
126	GCA424AT4	Fluorescent Lamp, + , L = 970 mm
127	GCA424AT-V1 GCA424AW---	Fluorescent Lamp, + , L = (min. 500 mm +25 + 25 → max. 1470 mm)

57-GAA26427F

**Trav-O-Lator® 606 NCT, Escalator 513
NPE-SR, 506NCE: Skirt Panel Lighting**

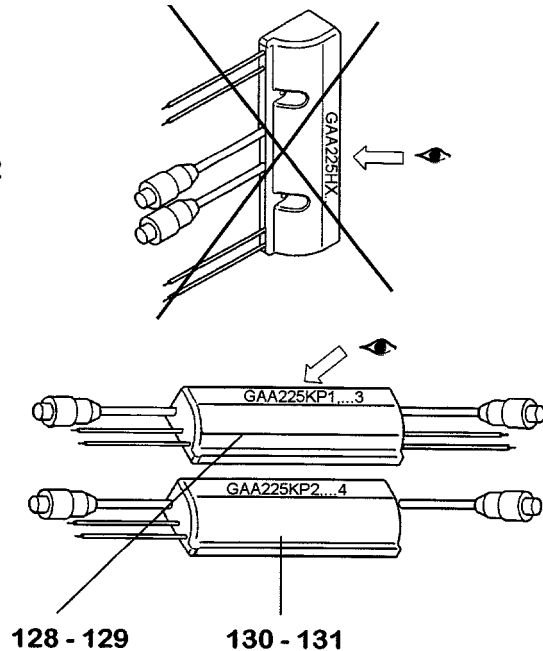
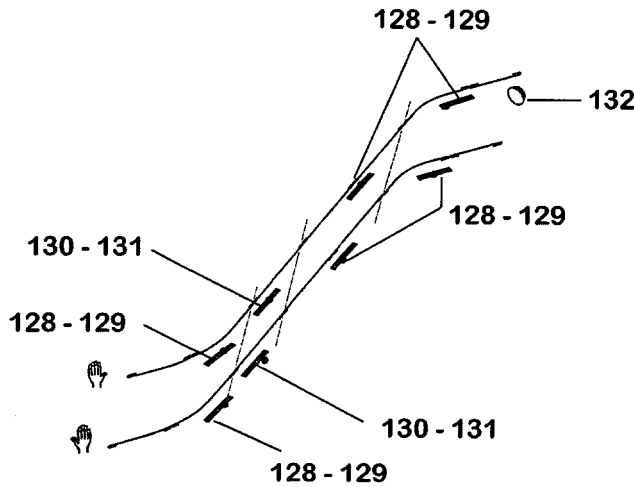

Replacement of transformers:

If transformers GAA225HX...are affected,you must replace the complete set of transformer GAA225HX.. by transformer GAA225KP..., because the earth leakage protective switch (GAA177GW1) controls the integrated earth leakage circuit of the transformer (GAA225KP...). For this reason it is absolutely necessary to implement this component.

Order the parts of the junction box as shown on next page.

In case of less space, provide locally a separate box for installation and wiring. The cable length for power supply (GAA174RM2, order 2 pieces) has to be adapted at jobsite.

For service-center: please add wiring diagram GEA26404A, sh.3+4 and GAA26427F sh.3.

After this replacement order the parts as shown, if necessary.

GAA26427F		
REF. No.	PART No.	DESCRIPTION
128	GAA225HX1 GAA225HX2 GAA225HX3 GAA225HX4	Transformer, Duplex, 230 V, 50 Hz
	GAA225KP1	
129	GAA225KP3	Transformer, Duplex, 230 V, 60 Hz
130	GAA225HX5 GAA225KP2	Transformer, Single, 230 V, 50 Hz
131	GAA225KP4	Transformer, Single, 230 V, 60 Hz
132	GAA176DS1	Bing Plug (2 pieces)
133	GEA26404A (sh. 3 + 4) GAA26427F (sh. 3)	Wiring Diagram

Trav-O-Lator® 606 NCT, Escalator 513 NPE-SR, 506NCE: Skirt Panel Lighting

57-GAA26427F

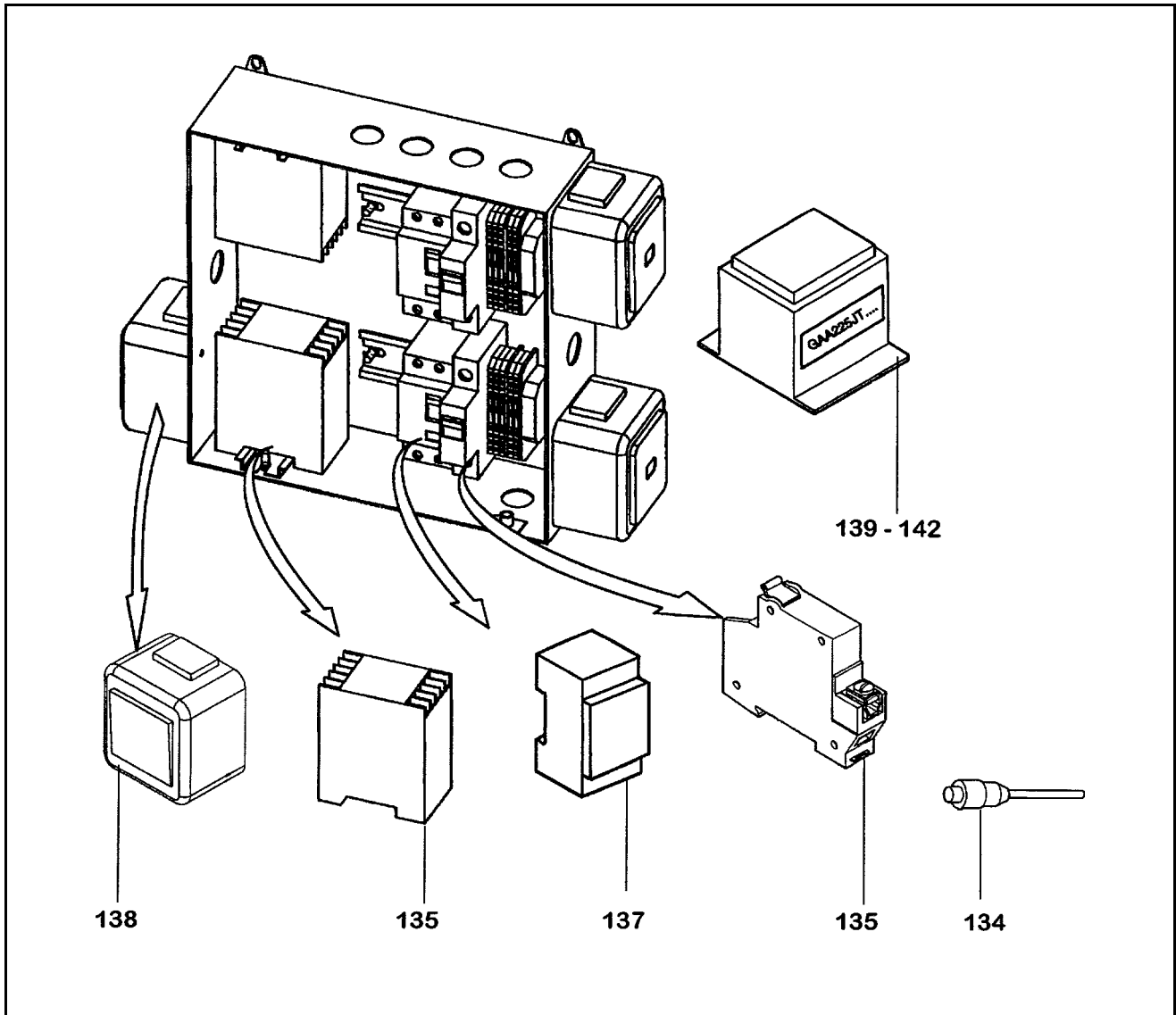

GAA26427 F		
REF. No.	PART No.	DESCRIPTION
134	GAA174RM2	Cable for Power Supply (2 pieces)
135	GAA375Y12 GAA637Z12	Circuit Breaker
136	GAA177GW1	Earth Leakage Protective Switch
137	GAA177EP1	Earth Leakage Circuit Breaker
138	GAA177FP1	Switch, Wall-Socket
139	GAA225JT1	Transformer, Input 240 V, Output 230 V, Nominal Current 8A, 50-60 Hz
140	GAA225JT2	Transformer, Input 220 V, Output 230 V, Nominal Current 12A, 50-60 Hz
141	GAA225JT3	Transformer, Input 240 V, Output 230 V, Nominal Current 12A, 50-60 Hz
142	GAA225JV1	Transformer, Input 100-120 V, Output 230 V, Nominal Current 8A, 50-60 Hz