

# NextStep™ Escalator Balustrade Decking, Aluminum

## Spare Parts Leaflet 57-GCA26228K

Nov. 15, 2007 / Page 1 of 8



- ◇ Inner Decking ALU.
- ◇ Outer Decking ALU.
- ◇ Step Flange Cover

👁 Page 5-8  
Outer Decking

👁 Page 3-4  
Inner Decking

👁 Step Flange Cover,  
Same as SPL  
57-G..26228Q  
page 6-15

**Leaflet Description**

Balustrade decking w/o lighting.

**Leaflet Revisions**

<b>Date Revised</b>	<b>Subject Matter Expert</b>	<b>Reason for Revision</b>
Mar. 19, 2004	Ye, Ke	Release
Jun. 30, 2004	Ye, Ke	Modification
Oct. 10, 2004	Ye, Ke	Modification
Dec. 30, 2004	Ye, Ke	Update according to new released engineering data
Nov. 30, 2005	Ye, Ke	Update according to new released engineering data
Nov. 15, 2007	Ye, Ke	GBA50AGW1 changed to GBA50AQJ1 On page 4.

**Related Drawings**

<b>Drawing No.</b>	<b>Title</b>	<b>Drawing No.</b>	<b>Title</b>
GCA26228K	Balustrade Decking		

**Related Documents**

<b>Document ID</b>	<b>Title</b>
BOM	Title

**Subject Matter Expert**

<b>Name</b>	<b>Department</b>
Ye, Ke	SIT-GUANGZHOU

**About Spare Parts Leaflets...**

This document lists the lowest replaceable units (LRUs) for the standard version of the product. The LRUs are chosen by a team of Otis associates representing engineering and manufacturing.







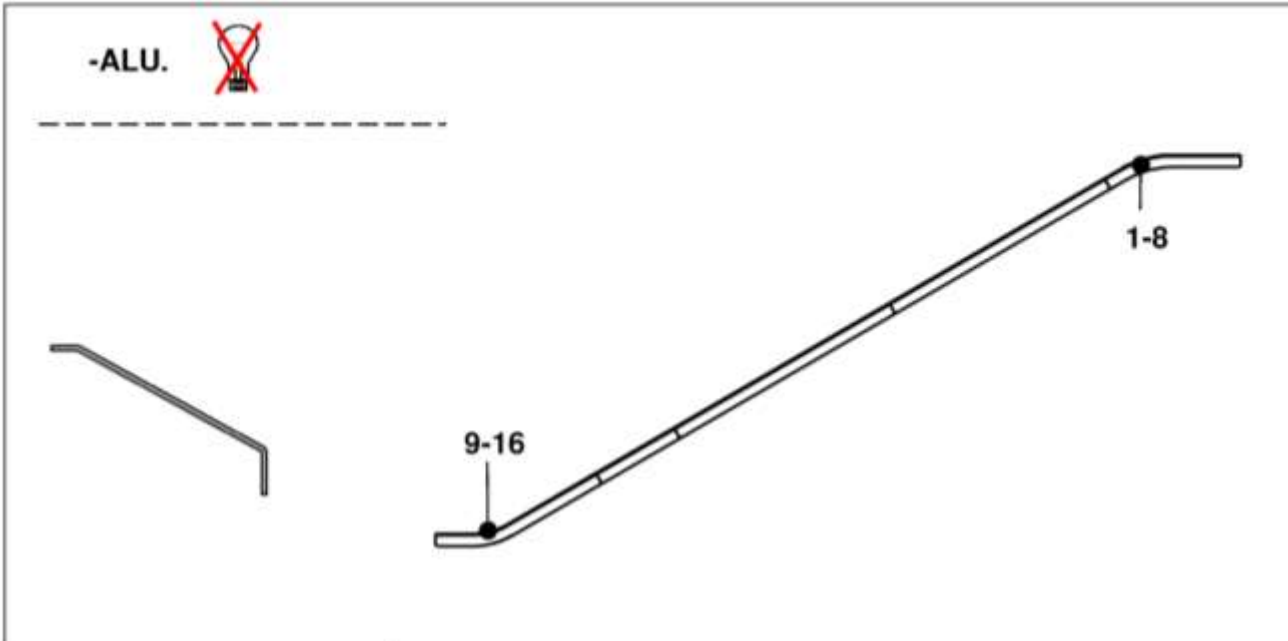

While goal of this document is to make parts identification as easy as possible, the document cannot be all-inclusive. Elevator and escalator contracts classified as "special" or "custom" are not addressed here. For such contracts, please refer to specified information, the contract folder, TIPs, Field Education Articles, Construction Letters, etc. for further information.

If you have any suggestions about this document, please contact the subject matter expert listed on this page.

# NextStep™ Escalator Balustrade Inner Decking

**57-GCA26228K**



GCA26228K				
REF. No.	PART No.	DESCRIPTION		
1	GAA402CEH1	Inner decking	Left side	2 Flat Steps
2	GAA402CEH2	Inner decking	Right side	
3	GAA402CEH3	Inner decking	Left side	3 Flat Steps
4	GAA402CEH4	Inner decking	Right side	
5	GAA402CEH5	Inner decking	Left side	2 Flat Steps
6	GAA402CEH6	Inner decking	Right side	
7	GAA402CEH7	Inner decking	Left side	3 Flat Steps
8	GAA402CEH8	Inner decking	Right side	
9	GAA402CEG1	Inner decking	Left side	2 Flat Steps
10	GAA402CEG2	Inner decking	Right side	
11	GAA402CEG3	Inner decking	Left side	3 Flat Steps
12	GAA402CEG4	Inner decking	Right side	
13	GAA402CEG5	Inner decking	Left side	2 Flat Steps
14	GAA402CEG6	Inner decking	Right side	
15	GAA402CEG7	Inner decking	Left side	3 Flat Steps
16	GAA402CEG8	Inner decking	Right side	

30°

35°

30°

35°

**57-GCA26228K**

# NextStep™ Escalator Balustrade Inner Decking

-ALU.

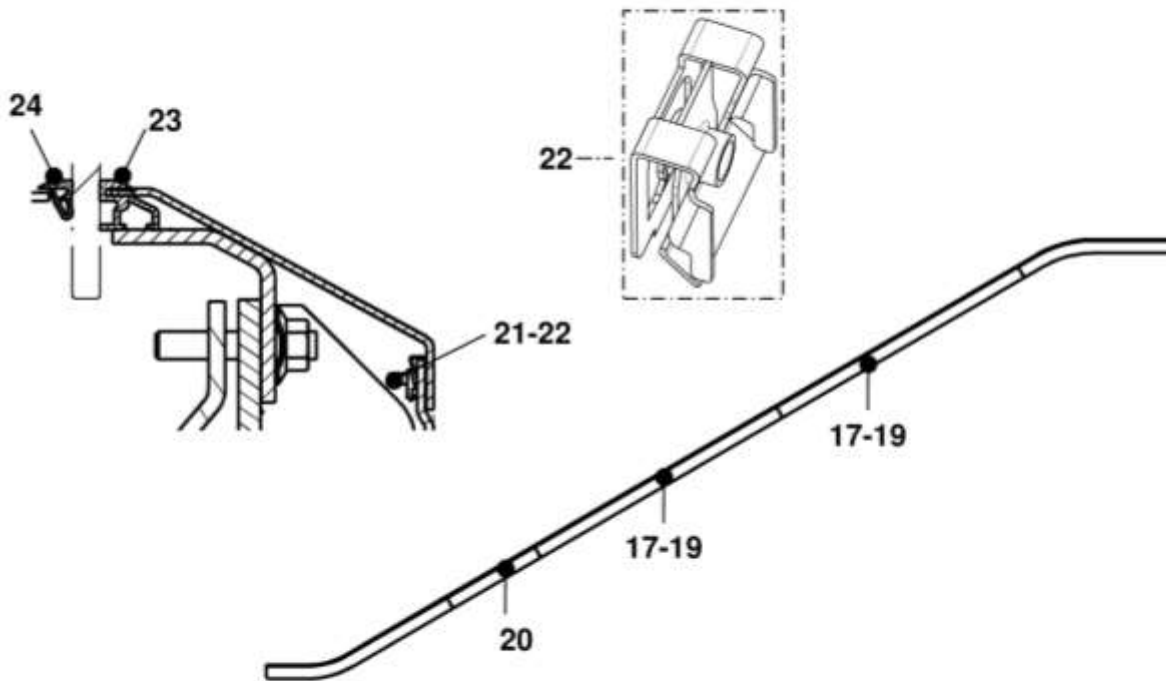

GCA26228K				
REF. No.	PART No.	DESCRIPTION		
17	GAA402CER1	Inner decking	Length=1960mm	
18	GAA402CER2	Inner decking	Length=2320mm	Finish: G2
19	GAA402CER3	Inner decking	Length=2960mm	
20	GAA402CER-V1	Inner decking	Per Spec. Length	Per Spec. Finish
21	DIN7991M4X16_10.9Z	Countersunk Head Screw		
22	GAA72BT1	Spring clip		
23	GAA50AGV1	Plastic Profile inner decking		
24	GBA50AQJ1	Plastic profile outer decking		

# NextStep™ Escalator Balustrade Inner Decking

**57-GCA26228K**

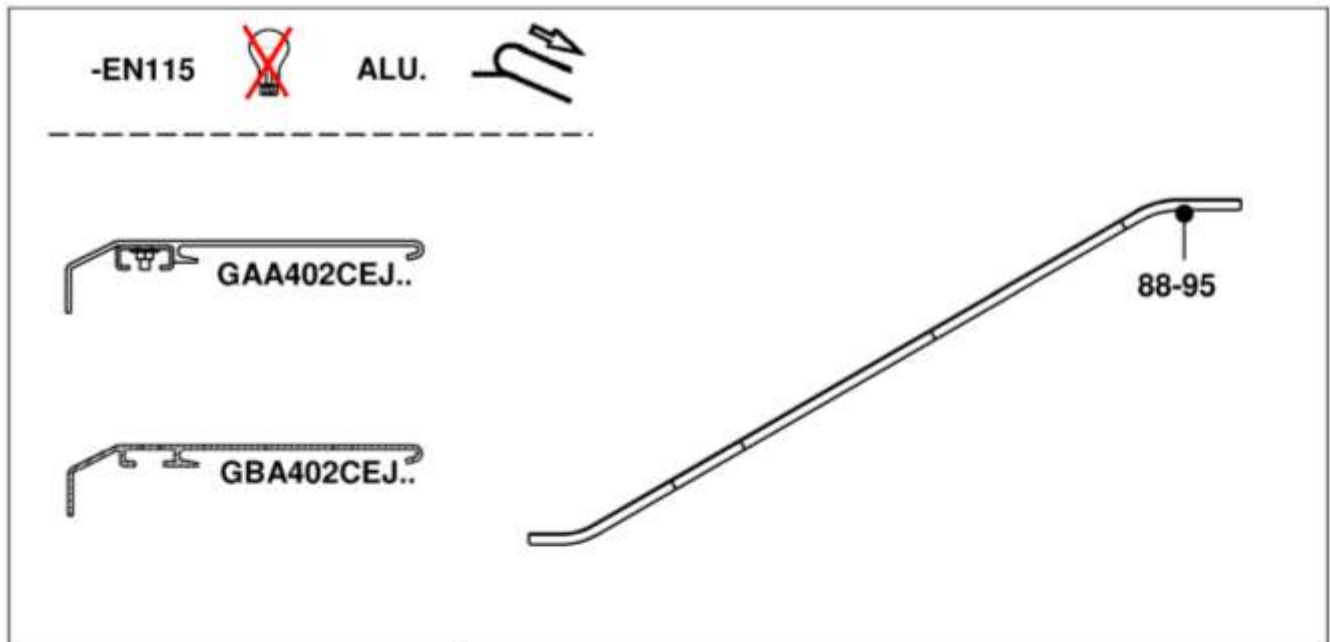









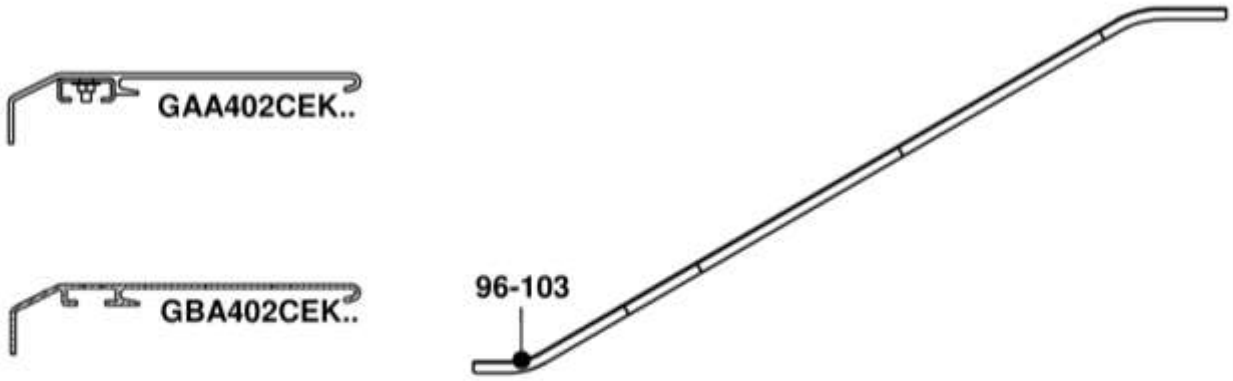





GCA26228K			
REF. No.	PART No.	DESCRIPTION	
88	GAA402CEJ1	Outer Decking	Left side
	GBA402CEJ1		
89	GAA402CEJ2	Outer Decking	Right side
	GBA402CEJ2		
90	GAA402CEJ3	Outer Decking	Left side
	GBA402CEJ3		
91	GAA402CEJ4	Outer Decking	Right side
	GBA402CEJ4		
92	GAA402CEJ5	Outer Decking	Left side
	GBA402CEJ5		
93	GAA402CEJ6	Outer Decking	Right side
	GBA402CEJ6		
94	GAA402CEJ7	Outer Decking	Left side
	GBA402CEJ7		
95	GAA402CEJ8	Outer Decking	Right side
	GBA402CEJ8		

**57-GCA26228K**

# NextStep™ Escalator Balustrade Inner Decking

-EN115  ALU. 







GCA26228K			
REF. No.	PART No.	DESCRIPTION	
96	GAA402CEK1 	Outer Decking	Left side
	GBA402CEK1 		
97	GAA402CEK2 	Outer Decking	Right side
	GBA402CEK2 		
98	GAA402CEK3 	Outer Decking	Left side
	GBA402CEK3 		
99	GAA402CEK4 	Outer Decking	Right side
	GBA402CEK4 		
100	GAA402CEK5 	Outer Decking	Left side
	GBA402CEK5 		
101	GAA402CEK6 	Outer Decking	Right side
	GBA402CEK6 		
102	GAA402CEK7 	Outer Decking	Left side
	GBA402CEK7 		
103	GAA402CEK8 	Outer Decking	Right side
	GBA402CEK8 		

# NextStep™ Escalator Balustrade Inner Decking

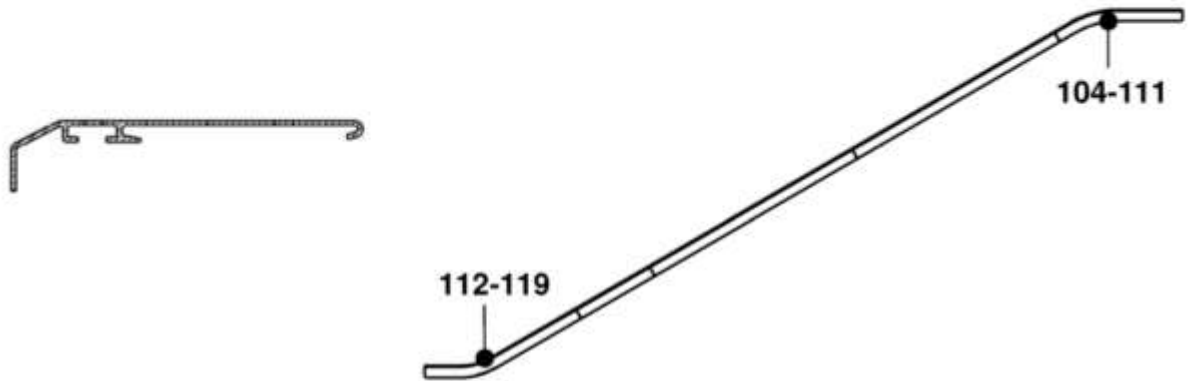
**57-GCA26228K**

-ASNI  ALU.







GCA26228K					
REF. No.	PART No.	DESCRIPTION			
104	GBA402CEJ9	Outer Decking	Left side	30°	
105	GBA402CEJ10	Outer Decking	Right side		
106	GBA402CEJ13	Outer Decking	Left side	35°	
107	GBA402CEJ14	Outer Decking	Right side		
108	GBA402CEJ11	Outer Decking	Left side	30°	
109	GBA402CEJ12	Outer Decking	Right side		
110	GBA402CEJ15	Outer Decking	Left side	35°	
111	GBA402CEJ16	Outer Decking	Right side		
112	GBA402CEK9	Outer Decking	Left side	30°	
113	GBA402CEK10	Outer Decking	Right side		
114	GBA402CEK13	Outer Decking	Left side	35°	
115	GBA402CEK14	Outer Decking	Right side		
116	GBA402CEK11	Outer Decking	Left side	30°	
117	GBA402CEK12	Outer Decking	Right side		
118	GBA402CEK15	Outer Decking	Left side	35°	
119	GBA402CEK16	Outer Decking	Right side		

**57-GCA26228K**

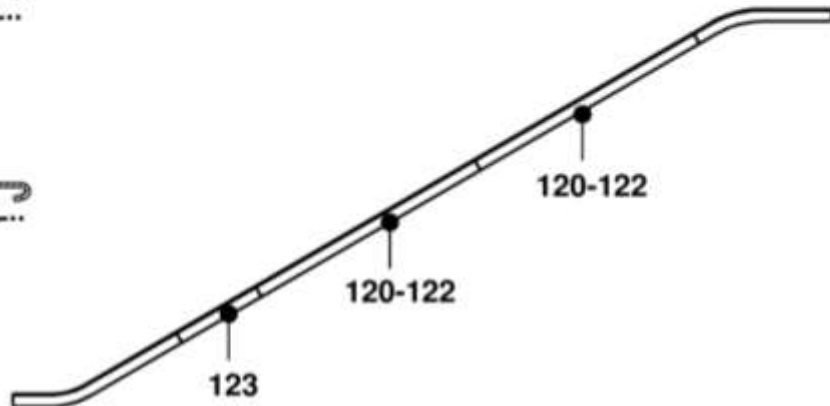
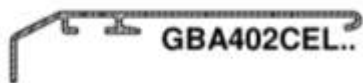
# NextStep™ Escalator Balustrade Inner Decking

-INCLINE  ALU.



GCA26228K			
REF. No.	PART No.	DESCRIPTION	
120	GAA402CEL1		Outer Decking      Length=1960mm
	GBA402CEL1		
121	GAA402CEL2		Outer Decking      Length=2320mm
	GBA402CEL2		
122	GAA402CEL3		Outer Decking      Length=2960mm
	GBA402CEL3		
123	GAA402CEL-V1		Outer Decking      Per Spec. Length
	GBA402CEL-V1		