

# ESCALATOR SKIRT PANEL

**Spare Parts Leaflet**

**57 - HE0804H**

**June 18, 2022 / Page 1 of 14**

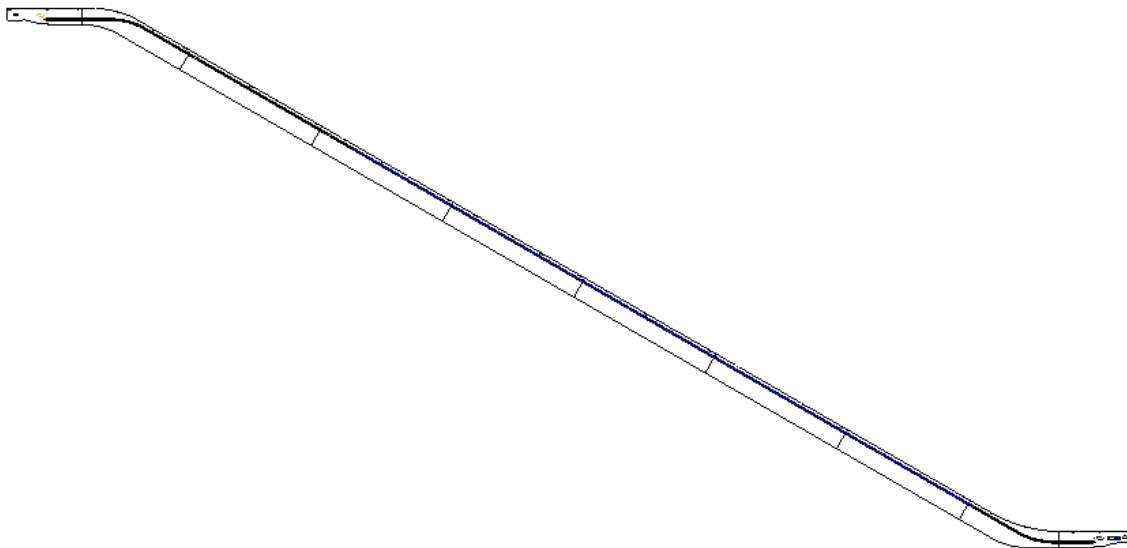

Unpublished Work—© Otis Elevator Co.

**OTIS**

**Safety First!**

**ELEVATOR ENGINEERING**  
**Otis Elevator Company**  
**OTIS ENGINEERING CHINA**  
**ESCALATOR**

# ESCALATOR

## 57 - HE0804H

# History

## Leaflet Description

### SKIRT PANEL

#### Leaflet Revisions

Date Revised	Subject Matter Expert	Reason for Revision
April 26, 2019	LILONG SHI	New SPL (CN NO.: CNT2001404)
June 18, 2022	WEN JIN	ADD BRUSH, ENDCAP, FASTENER FOR ENDCAP. (CN No.: CNT2200561)

#### Related Drawings

Drawing No.	Title	Drawing No.	Title
HAA438TM	UPPER LANDING SKIRT PANEL	HAA316EMD	INCLINED BRUSH HOLDER
HAA438TL	LOWER LANDING SKIRT PANEL	HAA316EME	UPPER CURVED BRUSH HOLDER
HAA438TK	UPPER CURVED SKIRT PANEL	HAA316EMF	LOWER CURVED BRUSH HOLDER
HAA438TH	LOWER CURVED SKIRT PANEL	HAA241AT	SAFETY BRUSH
HAA438TA	INCLINED SECTION SKIRT PANEL	HAA273AS	ENDCAP
HAA438TA	NONSTAND INCLINED SECTION SKIRT PANEL	XAA124G GAA72BT	WELDDING SCREW LOCKING SPRING NUT

#### Related Documents

Document ID	Title
HE0804H	ODS - SKIRT PANEL
HE0805G	ODS - SKIRT DEFLECTOR

#### Subject Matter Expert

Name	Department
LILONG SHI	SIT

#### About Spare Parts Leaflets...

This document lists the lowest replaceable units (LRUs) for the standard version of the product. The LRUs are chosen by a team of Otis associates representing engineering and manufacturing.

While goal of this document is to make parts identification as easy as possible, the document cannot be all-inclusive. Elevator and escalator contracts classified as "special" or "custom" are not addressed here. For such contracts, please refer to specified information, the contract folder, TIPS, Field Education Articles, Construction Letters, etc. for further information.

If you have any suggestions about this document, please contact the subject matter expert listed on this page.

**Spare Parts Leaflet  
57 - HE0804H**

**ESCALATOR  
SKIRT PANEL**

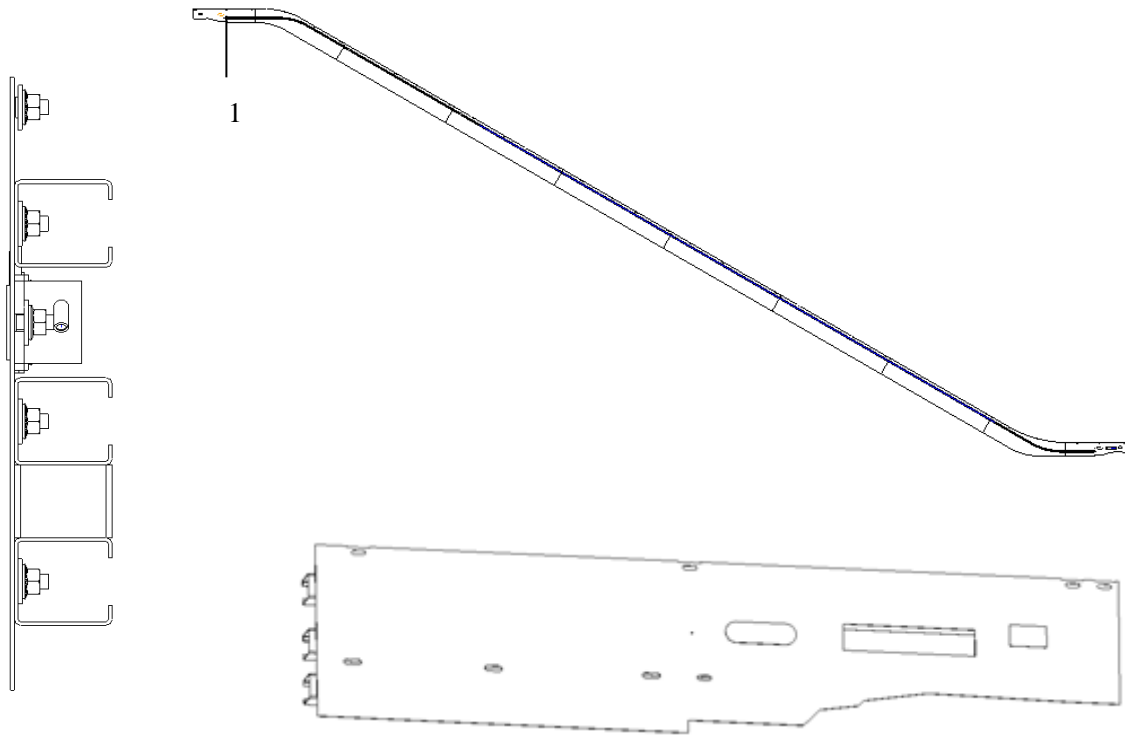

HE0804H						
REF. No.	PART No.	FLSTL sec	OUT PACK	COMBLC	MATERIAL	DESCRIPTION
1	HAA438TM993	2FSReal	NA, A3PK	WHITE, GREEN, BLUE, YELLOW	FG304_20, FG316_20, FG445_20, FH304_20, FH316_20, FH445_20, K235F_20	UPPER LANDING SKIRT PANEL, INDOOR, 2 flat step
	HAA438TM992					UPPER LANDING SKIRT PANEL, INDOOR, 2 flat step
	HAA438TM983		A1PK, A2PK, BPK,C PK			UPPER LANDING SKIRT PANEL, OUTDOOR, 2 flat step
	HAA438TM982					UPPER LANDING SKIRT PANEL, OUTDOOR, 2 flat step
	HAA438TM997	3FS	NA, A3PK			UPPER LANDING SKIRT PANEL, INDOOR, 3 flat step
	HAA438TM996					UPPER LANDING SKIRT PANEL, INDOOR, 3 flat step
	HAA438TM987		A1PK, A2PK, BPK,C PK			UPPER LANDING SKIRT PANEL, OUTDOOR, 3 flat step
	HAA438 TM986					UPPER LANDING SKIRT PANEL, OUTDOOR, 3 flat step

# ESCALATOR SKRIT PANEL

## Spare Parts Leaflet 57 - HE0804H

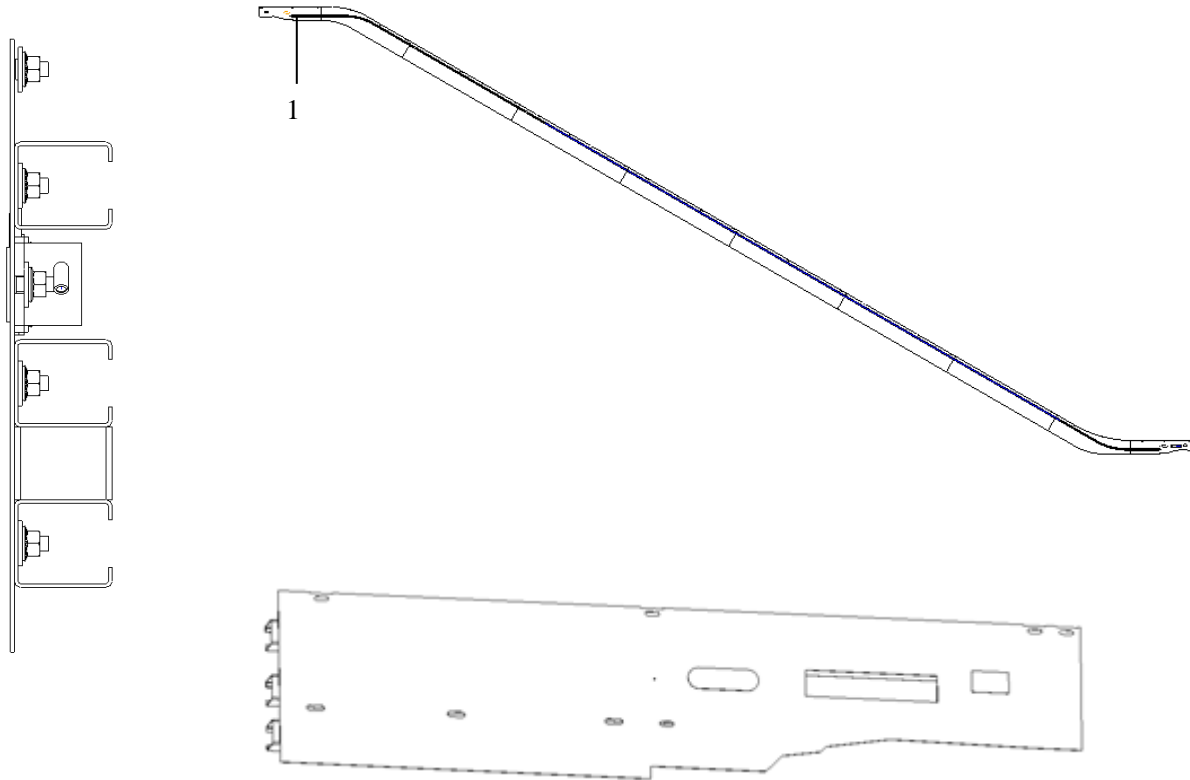

HE0804H						
REF. No.	PART No.	FLSTL sec	OUT PACK	COMBL C	MATERIAL	DESCRIPTION
1	HAA438TM973	2FSReal	NA, A3PK	NONE	FG304_20, FG316_20, FG445_20, FH304_20, FH316_20, FH445_20, K235F_20	UPPER LANDING SKIRT PANEL, INDOOR, 2 flat step
	HAA438TM972					UPPER LANDING SKIRT PANEL, INDOOR, 2 flat step
	HAA438TM963		A1PK, A2PK, BPK,C PK			UPPER LANDING SKIRT PANEL, OUTDOOR, 2 flat step
	HAA438TM962					UPPER LANDING SKIRT PANEL, OUTDOOR, 2 flat step
	HAA438TM977	3FS	NA, A3PK			UPPER LANDING SKIRT PANEL, INDOOR, 3 flat step
	HAA438TM976					UPPER LANDING SKIRT PANEL, INDOOR, 3 flat step
	HAA438TM967		A1PK, A2PK, BPK,C PK			UPPER LANDING SKIRT PANEL, OUTDOOR, 3 flat step
	HAA438TM966					UPPER LANDING SKIRT PANEL, OUTDOOR, 3 flat step

**Spare Parts Leaflet  
57 - HE0804H**

**ESCALATOR  
SKIRT PANEL**

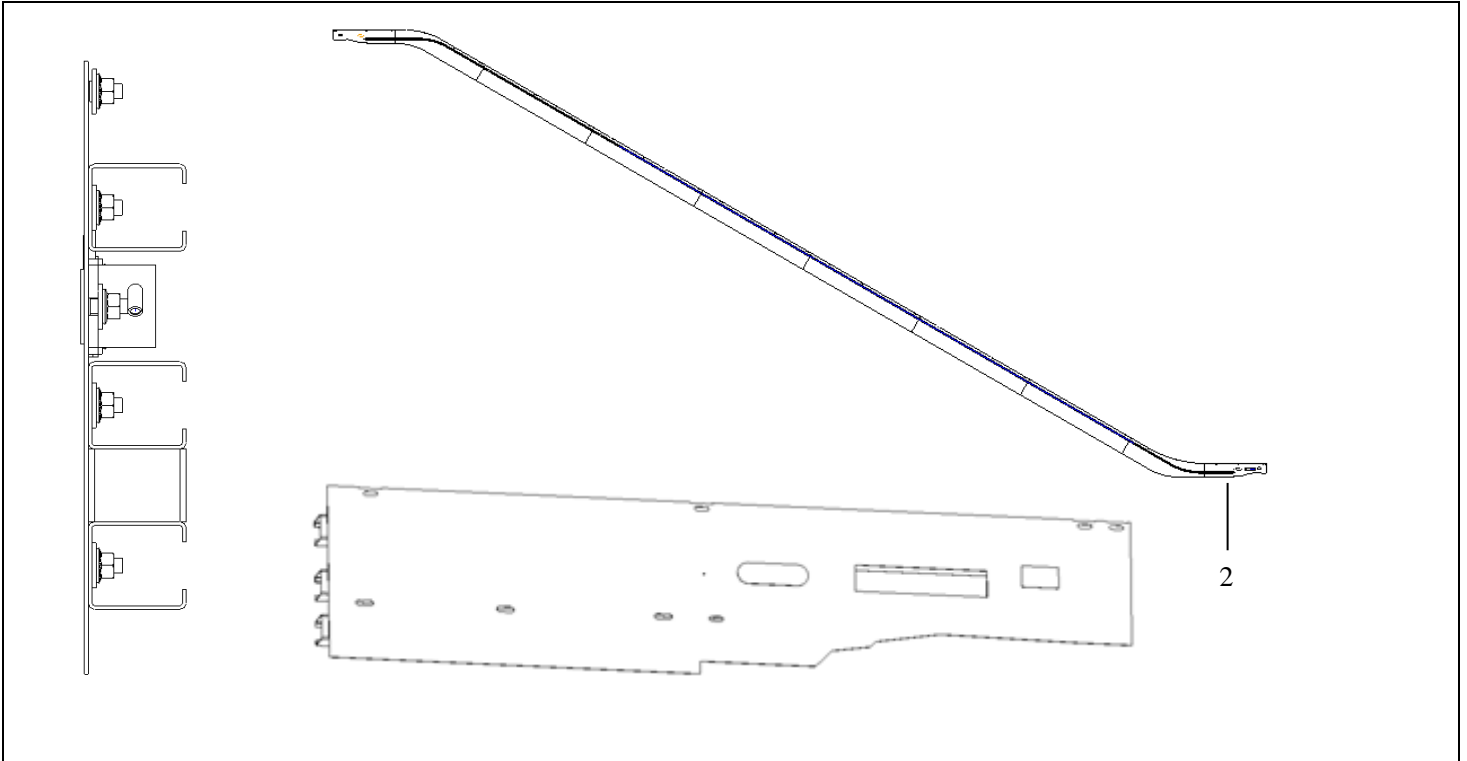

HE0804H		REF. No.	PART No.	FLSTL sec	OUT PACK	COMBLC	MATERIAL	DESCRIPTION
1	HAA438TL993	2FSRea I	NA, A3PK	WHITE, GREEN, BLUE, YELLOW	FG304_20, FG316_20, FG445_20, FH304_20, FH316_20, FH445_20, K235F_20		LOWER LANDING SKIRT PANEL, INDOOR, 2 flat step	✎
	HAA438TL992						LOWER LANDING SKIRT PANEL, INDOOR, 2 flat step	✎
	HAA438TL983		A1PK, A2PK, BPK,C PK				LOWER LANDING SKIRT PANEL, OUTDOOR, 2 flat step	✎
	HAA438TL982						LOWER LANDING SKIRT PANEL, OUTDOOR, 2 flat step	✎
	HAA438TL997	3FS	NA, A3PK				LOWER LANDING SKIRT PANEL, INDOOR, 3 flat step	✎
	HAA438TL996						LOWER LANDING SKIRT PANEL, INDOOR, 3 flat step	✎
	HAA438TL987		A1PK, A2PK, BPK,C PK				LOWER LANDING SKIRT PANEL, OUTDOOR, 3 flat step	✎
	HAA438 TL986						LOWER LANDING SKIRT PANEL, OUTDOOR, 3 flat step	✎

# ESCALATOR SKRIT PANEL

## Spare Parts Leaflet 57 - HE0804H

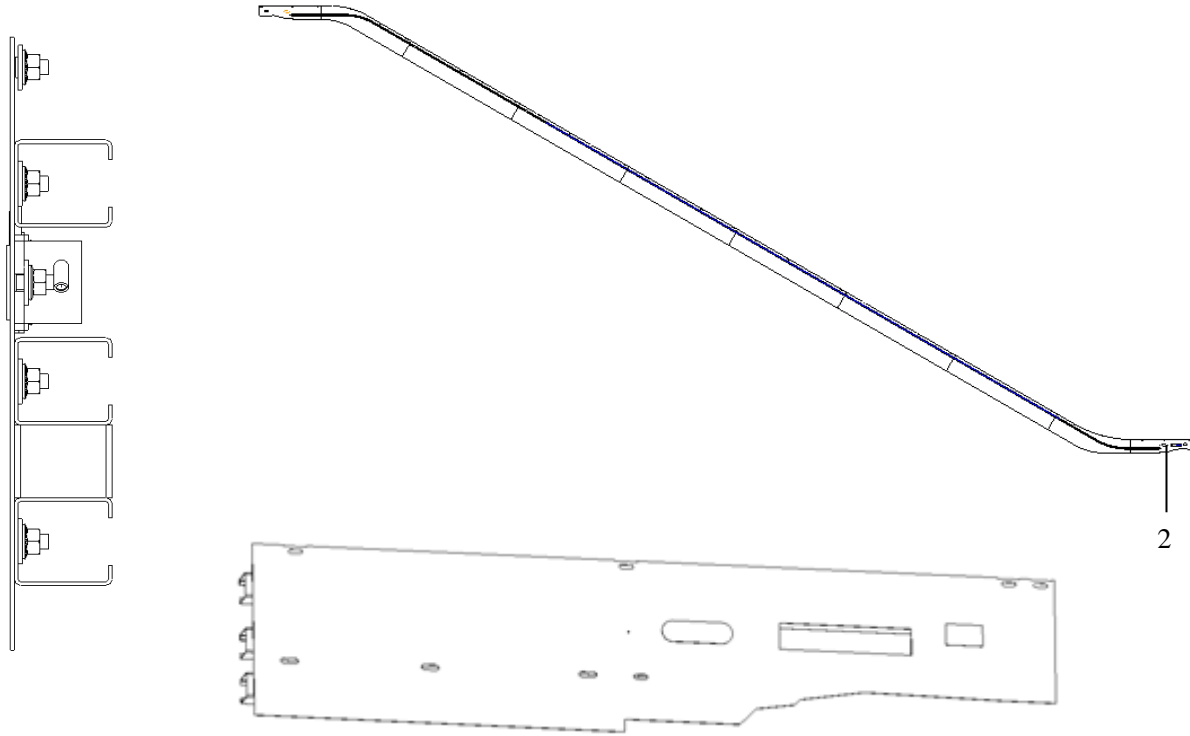

HE0804H						
REF. No.	PART No.	FLSTL sec	OUT PACK	COMBLC	MATERIAL	DESCRIPTION
2	HAA438TL973	2FSReal	NA, A3PK	NONE	FG304_20, FG316_20, FG445_20, FH304_20, FH316_20, FH445_20, K235F_20	LOWER LANDING SKIRT PANEL, INDOOR, 2 flat step
	HAA438TL972					LOWER LANDING SKIRT PANEL, INDOOR, 2 flat step
	HAA438TL963		A1PK, A2PK, BPK,C PK			LOWER LANDING SKIRT PANEL, OUTDOOR, 2 flat step
	HAA438TL962					LOWER LANDING SKIRT PANEL, OUTDOOR, 2 flat step
	HAA438TL977	3FS	NA, A3PK			LOWER LANDING SKIRT PANEL, INDOOR, 3 flat step
	HAA438TL976					LOWER R LANDING SKIRT PANEL, INDOOR, 3 flat step
	HAA438TL967		A1PK, A2PK, BPK,C PK			LOWER LANDING SKIRT PANEL, OUTDOOR, 3 flat step
	HAA438TL966					LOWER LANDING SKIRT PANEL, OUTDOOR, 3 flat step

**Spare Parts Leaflet**  
**57 - HE0804H**

**ESCALATOR**  
**SKRIT PAENL**

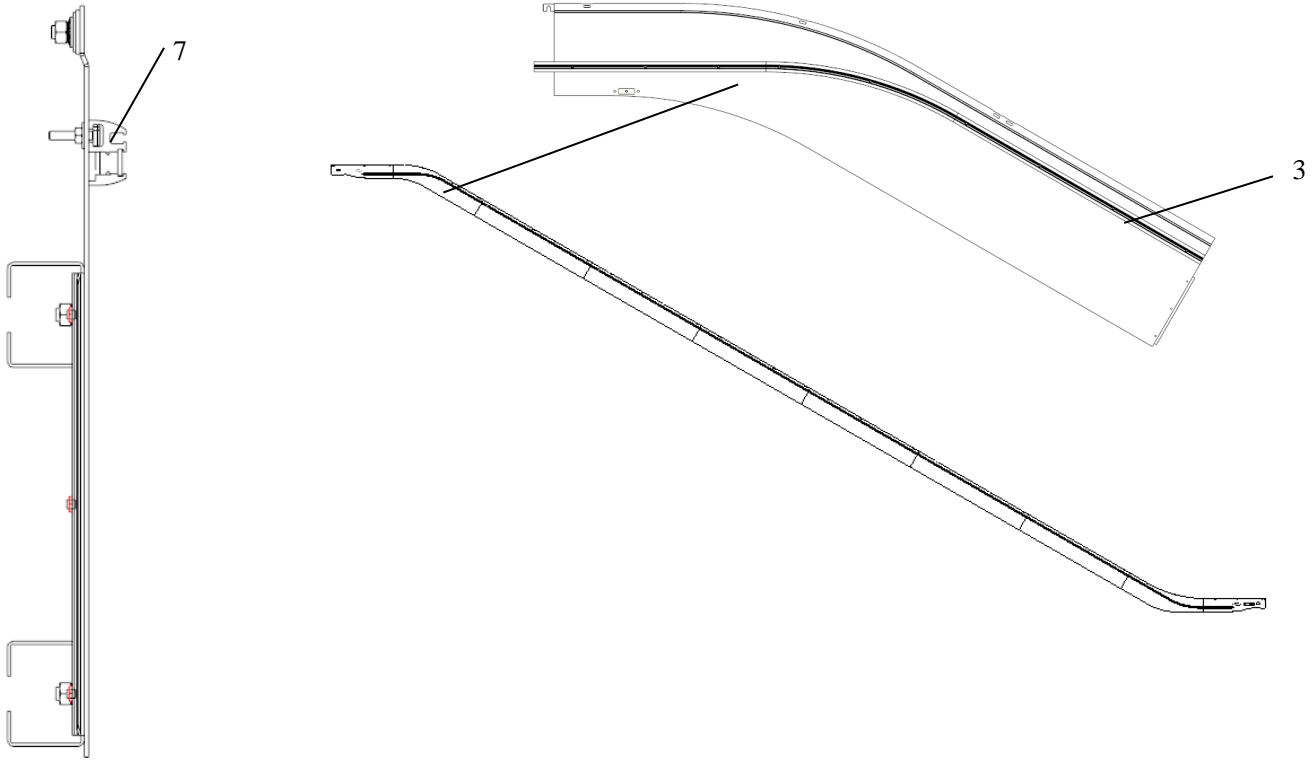







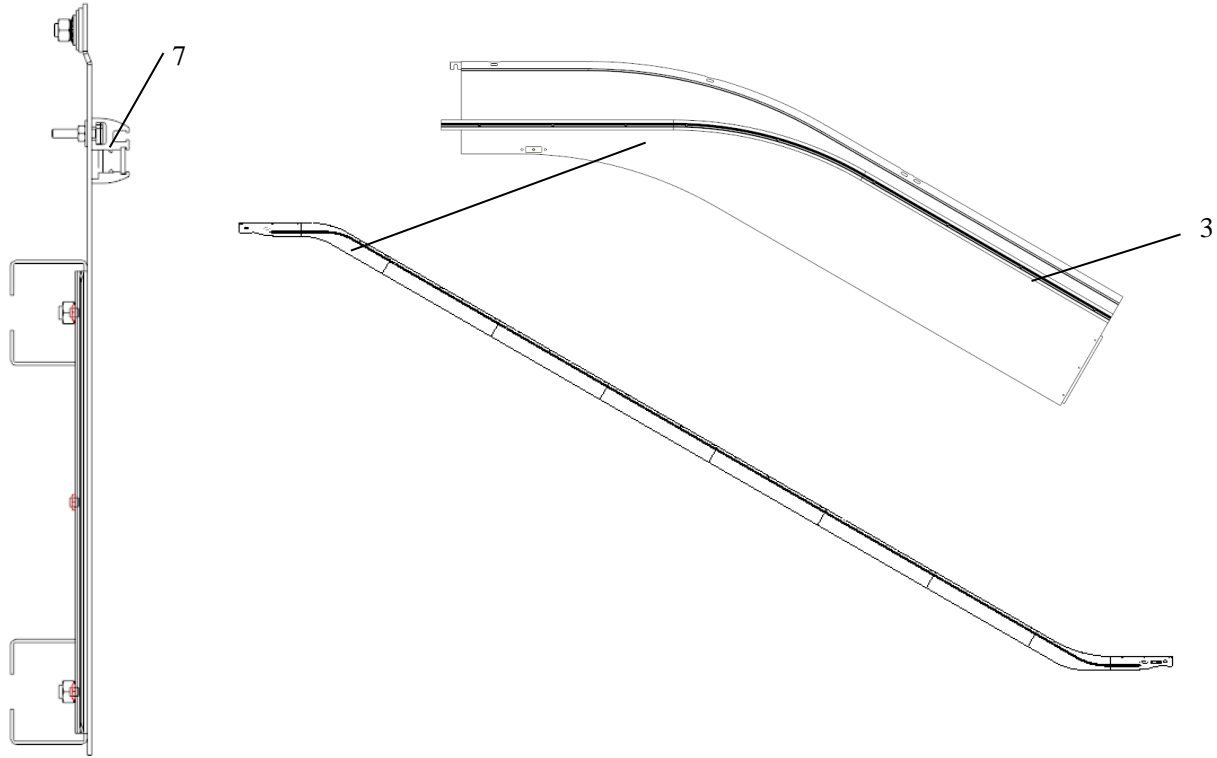





HE0804H					
REF. No.	PART No.	FLSTL sec	OUT PACK	DEFLDEVC	DESCRIPTION
3	HAA438TK997	2FSReal	NA, A3PK	BLACK	UPPER LANDING SKIRT PANEL
	HAA438TK996				UPPER LANDING SKIRT PANEL
	HAA438TK987		A1PK, A2PK, BPK, CPK		UPPER LANDING SKIRT PANEL
	HAA438TK986				UPPER LANDING SKIRT PANEL
	HAA438TK977	3FS	NA, A3PK		UPPER LANDING SKIRT PANEL
	HAA438TK976				UPPER LANDING SKIRT PANEL
	HAA438TK967		A1PK, A2PK, BPK, CPK		UPPER LANDING SKIRT PANEL
	HAA438TK966				UPPER LANDING SKIRT PANEL
7	HAA316EME5/6	2FSReal	ALL	BLACK	UPPER CURVED BRUSH HOLDER
	HAA316EME7/8	3FS	ALL		UPPER CURVED BRUSH HOLDER

**Spare Parts Leaflet**  
**57 - HE0804H**

**ESCALATOR**  
**SKRIT PAENL**











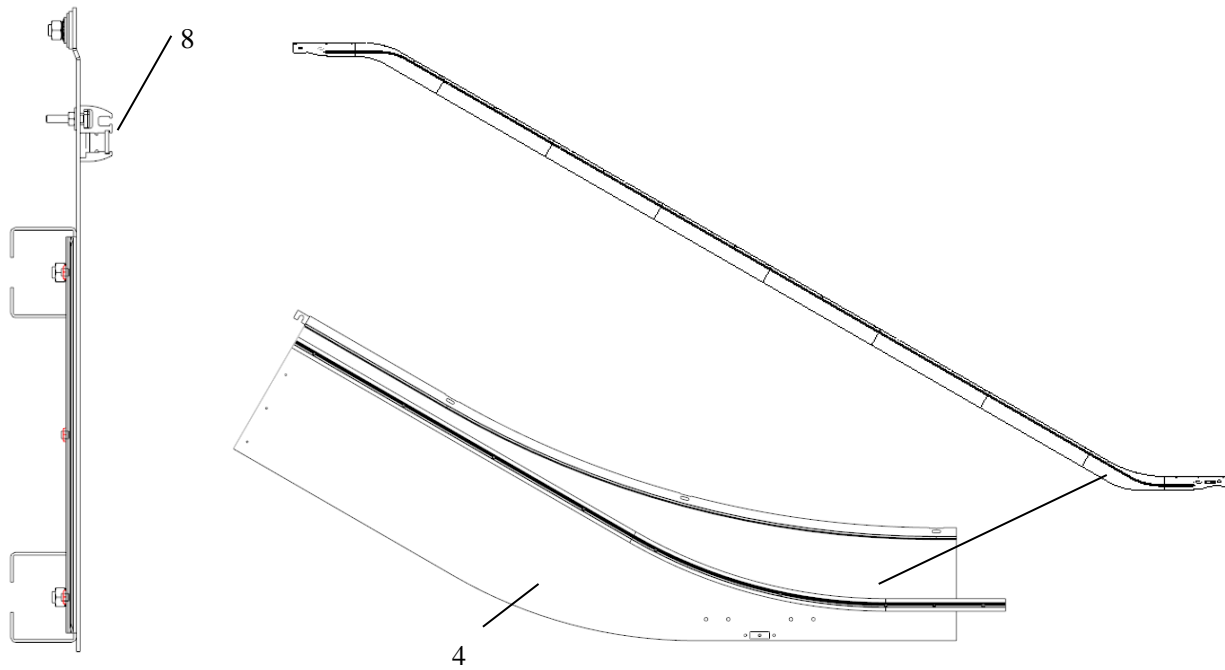



HE0804H					
REF. No.	PART No.	FLSTL sec	OUT PACK	DEFLDEVC	DESCRIPTION
3	HAA438TK957	2FSReal	NA, A3PK	SILVER	UPPER LANDING SKIRT PANEL 
	HAA438TK956				UPPER LANDING SKIRT PANEL 
	HAA438TK947		A1PK, A2PK, BPK, CPK		UPPER LANDING SKIRT PANEL 
	HAA438TK946				UPPER LANDING SKIRT PANEL 
	HAA438TK937	3FS	NA, A3PK		UPPER LANDING SKIRT PANEL 
	HAA438TK936				UPPER LANDING SKIRT PANEL 
	HAA438TK927		A1PK, A2PK, BPK, CPK		UPPER LANDING SKIRT PANEL 
	HAA438TK926				UPPER LANDING SKIRT PANEL 
7	HAA316EME1/2	2FSReal	ALL	SILVER	UPPER CURVED BRUSH HOLDER  
	HAA316EME3/4	3FS	ALL		UPPER CURVED BRUSH HOLDER  



**Spare Parts Leaflet  
57 - HE0804H**

**ESCALATOR  
SKRIT PAENL**









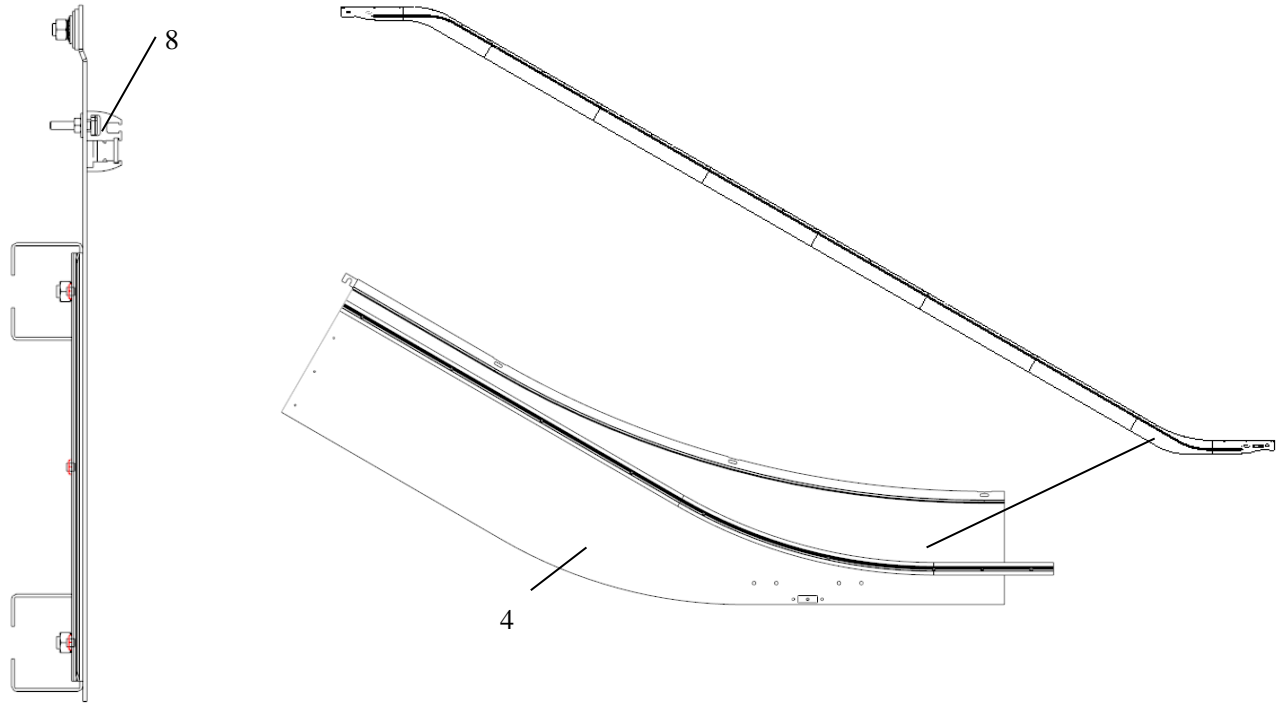





HE0804H					
REF. No.	PART No.	FLSTL sec	OUT PACK	DEFLDEV	DESCRIPTION
4	HAA438TH997	2FSReal	NA, A3PK	BLACK	LOWER LANDING SKIRT PANEL 
	HAA438TH996				LOWER LANDING SKIRT PANEL 
	HAA438TH987		A1PK, A2PK, BPK, CPK		LOWER LANDING SKIRT PANEL 
	HAA438TH986				LOWER LANDING SKIRT PANEL 
	HAA438TH977	3FS	NA, A3PK		LOWER LANDING SKIRT PANEL 
	HAA438TH976				LOWER LANDING SKIRT PANEL 
	HAA438TH967		A1PK, A2PK, BPK, CPK		LOWER LANDING SKIRT PANEL 
	HAA438TH966				LOWER LANDING SKIRT PANEL 
8	HAA316EMF5/6	2FSReal	ALL	BLACK	LOWER CURVED BRUSH HOLDER  
	HAA316EMF7/8	3FS	ALL		LOWER CURVED BRUSH HOLDER  

**Spare Parts Leaflet**  
**57 - HE0804H**

**ESCALATOR**  
**SKRIT PAENL**



HE0804H					
REF. No.	PART No.	FLSTL sec	OUT PACK	DEFLDEV	DESCRIPTION
4	HAA438TH997	2FSReal	NA, A3PK	SILVER	LOWER LANDING SKIRT PANEL 
	HAA438TH996				LOWER LANDING SKIRT PANEL 
	HAA438TH987		A1PK, A2PK, BPK, CPK		LOWER LANDING SKIRT PANEL 
	HAA438TH986				LOWER LANDING SKIRT PANEL 
	HAA438TH977	3FS	NA, A3PK		LOWER LANDING SKIRT PANEL 
	HAA438TH976				LOWER LANDING SKIRT PANEL 
	HAA438TH967		A1PK, A2PK, BPK, CPK		LOWER LANDING SKIRT PANEL 
	HAA438TH966				LOWER LANDING SKIRT PANEL 
8	HAA316EMF1/2	2FSReal	ALL	SILVER	LOWER CURVED BRUSH HOLDER  
	HAA316EMF3/4	3FS	ALL		LOWER CURVED BRUSH HOLDER  

**Spare Parts Leaflet  
57 - HE0804H**

**ESCALATOR  
SKRIT PAENL**

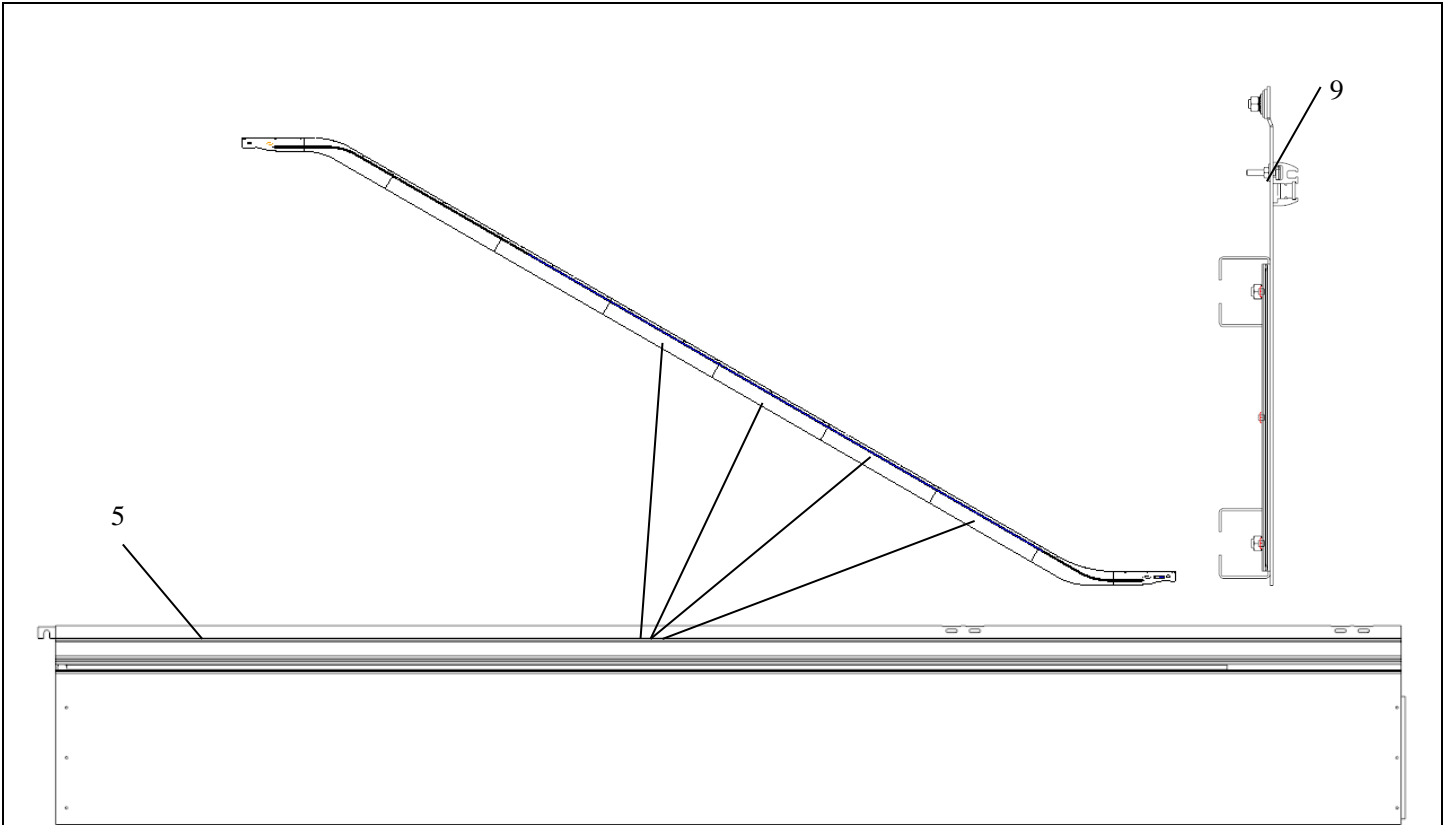









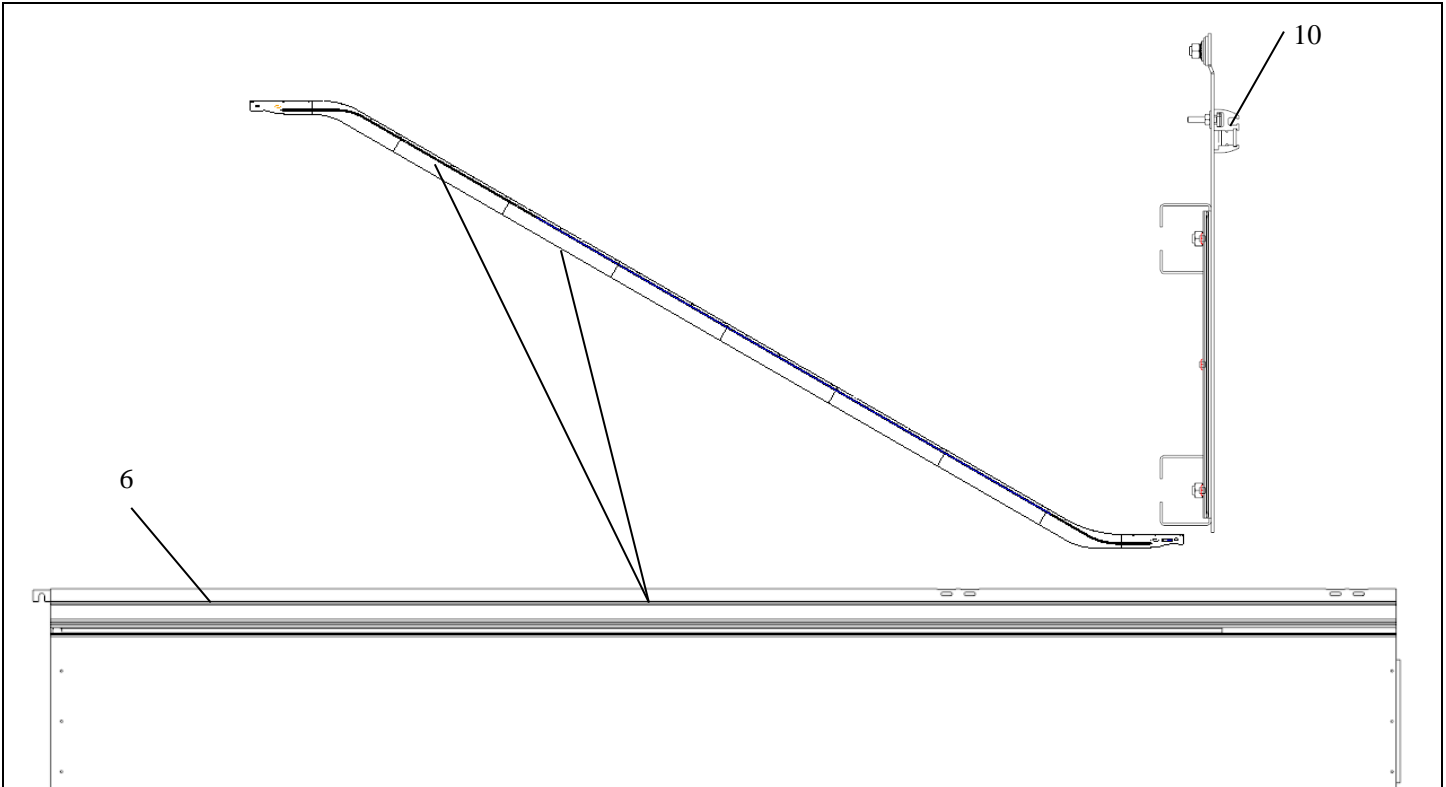



		<b>HE0804H</b>			
<b>REF. No.</b>	<b>PART No.</b>	<b>OUT PACK</b>	<b>DEFLD EVC</b>	<b>DESCRIPTION</b>	
5	HAA438TA997	NA, A3PK	BLACK	INCLINED SECTION SKIRT PANEL, INDOOR, 2320	👉
	HAA438TA996			INCLINED SECTION SKIRT PANEL, INDOOR, 2320	👉
	HAA438TA987	A1PK, A2PK, BPK, CPK		INCLINED SECTION SKIRT PANEL, OUTDOOR, 2320	👉
	HAA438TA986			INCLINED SECTION SKIRT PANEL, OUTDOOR, 2320	👉
	HAA438TA977	NA, A3PK	SILVER	INCLINED SECTION SKIRT PANEL, INDOOR, 2320	👉
	HAA438TA976			INCLINED SECTION SKIRT PANEL, INDOOR, 2320	👉
	HAA438TA967	A1PK, A2PK, BPK, CPK		INCLINED SECTION SKIRT PANEL, OUTDOOR, 2320	👉
	HAA438TA966			INCLINED SECTION SKIRT PANEL, OUTDOOR, 2320	👉
9	HAA316EMD3/4	ALL	BLACK	INCLINED BRUSH HOLDER	👉 👉
	HAA316EMA1/2	ALL	SILVER	INCLINED BRUSH HOLDER	👉 👉



**Spare Parts Leaflet  
57 - HE0804H**

**ESCALATOR  
SKRIT PAENL**



HE0804H				
REF. No.	PART No.	OUT PACK	DEFLD EVC	DESCRIPTION
6	HAA438TA993	NA, A3PK	BLACK	NONSTANDARD INCLINED SECTION SKIRT PANEL, INDOOR 
	HAA438TA992			NONSTANDARD INCLINED SECTION SKIRT PANEL, INDOOR 
	HAA438TA983	A1PK, A2PK, BPK, CPK		NONSTANDARD INCLINED SECTION SKIRT PANEL, OUTDOOR 
	HAA438TA982			NONSTANDARD INCLINED SECTION SKIRT PANEL, OUTDOOR 
	HAA438TA973	NA, A3PK	SILVER	NONSTANDARD INCLINED SECTION SKIRT PANEL, INDOOR 
	HAA438TA972			NONSTANDARD INCLINED SECTION SKIRT PANEL, INDOOR 
	HAA438TA963	A1PK, A2PK, BPK, CPK		NONSTANDARD INCLINED SECTION SKIRT PANEL, OUTDOOR 
	HAA438TA962			NONSTANDARD INCLINED SECTION SKIRT PANEL, OUTDOOR 
10	HAA316EMD 997/996	ALL	BLACK	INCLINED BRUSH HOLDER  
	HAA316EMD 999/998	ALL	SILVER	INCLINED BRUSH HOLDER  

**Spare Parts Leaflet  
57 - HE0804H**

**ESCALATOR  
SKRIT PAENL**

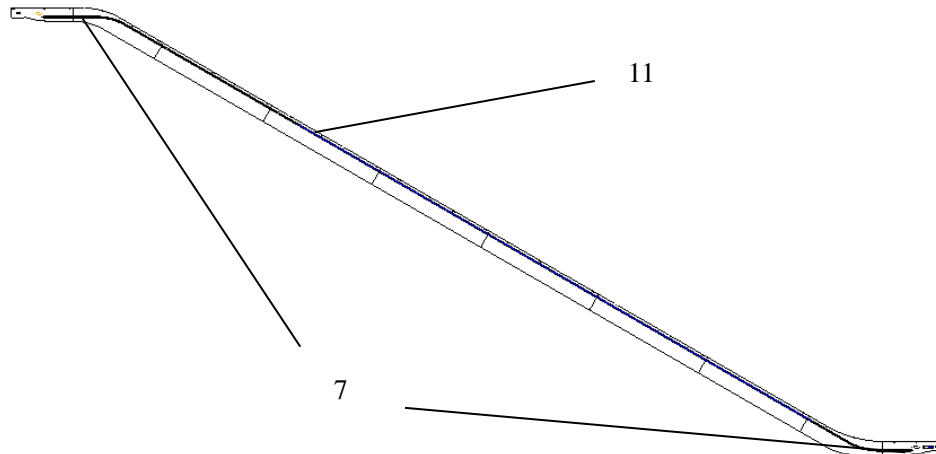



<b>HE0804H</b>				
<b>REF. No.</b>	<b>PART No.</b>	<b>OUT PACK</b>	<b>DEFLD EVC</b>	<b>DESCRIPTION</b>
7	HAA241AT3	NA, A3PK	BLACK	SAFETY BRUSH, INDOOR
11	HAA241AT1			SAFETY BRUSH, INDOOR
7	HAA241AT4	A1PK, A2PK, BPK, CPK		SAFETY BRUSH, OUTDOOR
11	HAA241AT2			SAFETY BRUSH, OUTDOOR
7	HAA241AT11	NA, A3PK	CLEAR	SAFETY BRUSH, INDOOR
11	HAA241AT9			SAFETY BRUSH, INDOOR
7	HAA241AT12	A1PK, A2PK, BPK, CPK		SAFETY BRUSH, OUTDOOR
11	HAA241AT10			SAFETY BRUSH, OUTDOOR

**Spare Parts Leaflet  
57 - HE0804H**

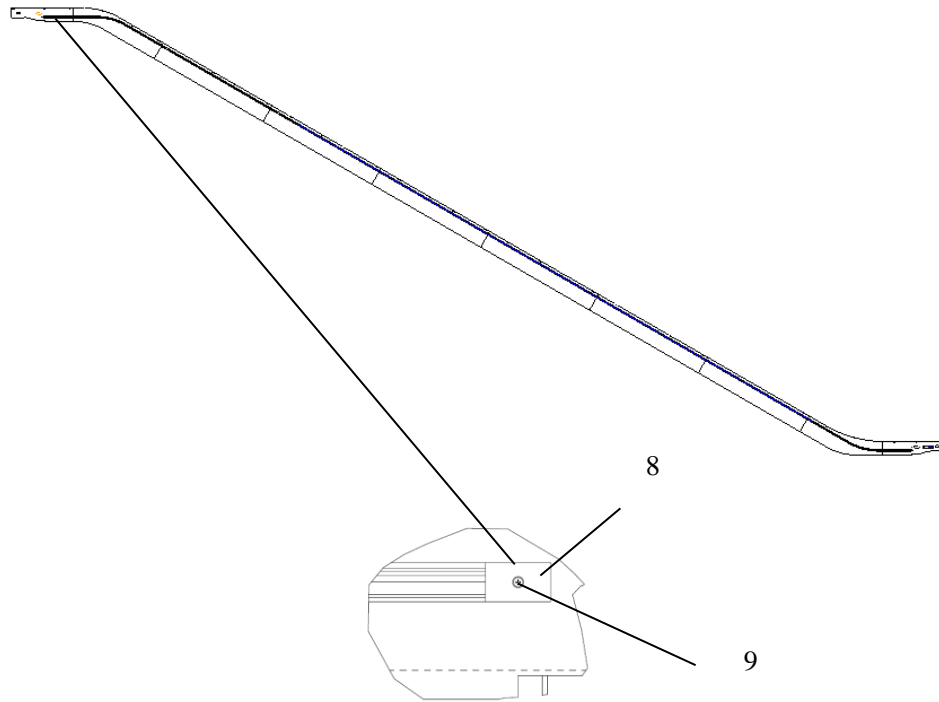
**ESCALATOR  
SKRIT PAENL**



HE0804H			
REF. No.	PART No.	OUT PACK	DESCRIPTION
8	HAA273AS1	NA, A3PK A1PK, A2PK,	ENDCAP 
11	HAA273AS2	BPK, CPK	ENDCAP 
7	XAA124G1	NA, A3PK	WELDDING SCREW
11	GAA72BT1	A1PK, A2PK, BPK, CPK	LOCKING SPRING NUT