

PC BOARDS

OTIS®

©2010, Otis Elevator Company (rev. November 2010)

North America: (800) 600 - 6847 • Fax (860) 286 - 1605
Elsewhere: (860) 286-4573 • lynn.molinaroli@otis.com

OTIS

About This Catalog

This catalog lists many of the printed circuit boards that can be purchased, repaired, or exchanged by the Otis Electronics Shop at the Otis Service Center in Bloomfield, Connecticut.

It also contains some of the related electronics the E-Shop repairs, such as contactors, heat sinks, and drives.

There is a chapter for each elevator manufacturer for which boards are available, and they are presented alphabetically. Within the longer chapters, there are subsections for each elevator/escalator system, which are also in alphabetical order. For each part number that is provided, a brief description is given along with any related part numbers (alternate, substituted, or superseded numbers). In most cases, the system on which the board is used is given, and many of the listings are accompanied by a photo of the board.

Subsequent revisions of this catalog will feature additional photos and enhanced descriptions.

Note that a great many PC boards have their part number stamped on the board itself, or applied via a label. For those used on non-Otis systems, our Otis part numbers are the manufacturer's part number preceded by a company prefix (such as WEST for Westinghouse). Refer to the note below for further information.

Terminology & Symbols

Part Number: The part number you will use to order the part from OSC.

Description: PCB description.

Alt/Sub/Sup P/N: Any alternate, substituted, or superseded part numbers for this board.

* An asterisk designates boards that can currently be repaired only, and are not available for purchase or exchange.

NOTE: OSC lines up non-Otis boards using the original manufacturer's part number with an OEM prefix assigned by OSC (e.g., DOVR9715710). Refer to TIP 50.0-1, *SDC Competitor Prefixes* for a complete listing.

Choice...

Exchange

Reducing downtime is the most critical component of quality elevator service. Exchanging your PC board is the most efficient and cost-effective method to get an elevator back in service quickly. Place an exchange order with OSC and a replacement board is delivered overnight. Ship the old PC board to OSC and receive a credit, as long as it can be repaired. The exchange program helps to handle PC board obsolescence, manage OSC inventory more efficiently, and ensure that active Otis boards remain with Otis throughout their life cycle.

Repair

OSC's PC board process includes troubleshooting, replacing defective components, and testing. Our in-circuit, functional, and simulator testing capabilities help ensure your board is fixed right the first time. To identify quality issues, all defective PC boards should be returned using a code 31 return authorization.

Purchase

Available PC boards are also available for purchase.

Repairs & Exchanges Help You and Environment

By sending old PC Boards and other repairable electronics to the OSC E-Shop for repair/exchange, you saved the company \$16 million dollars over the cost of simply buying new boards in 2008. Not only that, but you've done a great thing for the environment. By "e-cycling" your electronics, you keep nearly 1500 parts out of landfills each month—that's more than 250,000 parts in the last 20 years. These electronic parts are especially bad in landfills because they contain lead, cadmium, mercury, beryllium, nickel, zinc, and brominated flame retardants. If not properly "e-cycled" these toxic materials present serious environmental issues in landfills and even underlying water sources. So make sure to take full advantage of the repair and exchange options the OSC E-Shop offers and you'll be helping the company stay competitive (which helps your bottom line) and helping preserve our Earth for your children.

Table of Contents

About This Catalog	2
Terminology & Symbols	2
Choice.....	2
Exchange.....	2
Repair	2
Purchase	2
Repairs & Exchanges Help You and Environment.....	2
Armor	7
Dynaglide	7
BAXCO	9
CEC.....	10
Modmaster / Swift 5000.....	10
Modmaster / Swift 5000 w/DSD 412 Drive.....	12
Swift 5000 CPU.....	12
Swift Futura	12
Swift Futura w/SCR Drive.....	13
Delta	15
Dover.....	16
Composite.....	16
DMC-I	17
Fixture	19
MMII	20
MSC-I.....	21
Oildraulic.....	21
Solid State.....	22
Selector and Position Devices.....	24
T-I, T-II.....	25
T-II	25
TII Selector & Position Devices	26
TIII	27
TIII & TIV	29
TIV	30
Miscellaneous	32

OTIS

Table of Contents

FUJITEC.....	35
MIC 300.....	35
Millennium	36
Haughton	38
1092	38
Accuflyte	40
Dynatron GAC IV	41
Electronic Stepping Switch.....	42
Escalator.....	42
EVC, ELC	42
Goldflight	43
Hydro	50
Miconic	50
Static Drives Reliance Cards.....	51
Miscellaneous	53
KONE.....	55
KCM 831.....	55
TMS 900	56
MCE.....	58
Millar.....	61
Montgomery.....	62
Door.....	62
Escalator.....	63
Hydro	64
MAC Door Operator	65
MIPROM 21	67
MIPROM Hydro and Traction.....	72
SSC-6010	78
Otis81	
506 Escalators.....	81
Balance Bridge Detector	81
Black Belt Door Operator.....	81
CB Base	82
Elevonic 211	94

PC BOARDS

Elevonic 101 & 401	95
Elevonic 311 & 411	107
Elevonic 335M	117
GAMMA D	118
GEM, MVS	120
Fixtures.....	121
IDS 121	
LR, LRV, LHM, LRV	122
MPGC	125
MRQ, EMO, TEMO	126
MRS, MRV, MRVF, LR.....	127
VIP260	135
Miscellaneous	138
Reliance	142
Schindler	143
321A Hydro, 321A/330A.....	143
Escalator.....	143
Goldflight	144
Miconic 300A	145
Miconic A.....	147
QKS Operator	147
Miscellaneous	148
Swift.....	149
Swift 5000 Modmaster with 3412 Drive.....	149
Thames Valley.....	150
Thyssen-Krupp	151
TAC 20	151
TAC 50, TAC 50-04.....	160
US Elevator	167
Ascension 1000.....	167
MP-1200, MP-1210, MP-1220.....	168
Westinghouse	172
DMR.....	172
Door Operator	173
Epoch.....	174

OTIS

Table of Contents



ER8, ER9, ERL.....	182
Fixtures.....	182
Motor Drive (MD-1A).....	183
Motrol	184
Mark IV, Mark V	186
Motor Drive.....	194
MPH.....	195
QKS Operator	199
Relay.....	200
Miscellaneous	201
World Elevator	202

PC BOARDS

Armor

Dynaglide

©2010, Otis Elevator Company (rev. November 2010)

Image	Part Number	Description	Alt/Sub/Sup P/N
<i>Photo Not Available</i>	*ARMRD0588371-01	Car Control	
	ARMRD-058-8009-01	Car Control Board	
<i>Photo Not Available</i>	ARMR058-8502-01	Current Brake / Field Board	MTGM515629
<i>Photo Not Available</i>	ARMRC058-826105	PC Timer 0.5-5 Sec.	AFET1MGTIMERKIT
<i>Photo Not Available</i>	*ARMRC058-8261-0418	PC Timer Board	
	ARMRD-058-8007-01	Thyristor	
<i>Photo Not Available</i>	*ARMRD058800702	Thyristor Board	
<i>Photo Not Available</i>	ARMRC058-8261-05	Timer 0.5-5 Sec.	AFET1MGTIMERKIT
<i>Photo Not Available</i>	*ARMRC05882630-208	Timer Board	
<i>Photo Not Available</i>	ARMRC058826104	Timer, 0.5-5 Sec., 110 VDC	AFET250KTIMERKIT
<i>Photo Not Available</i>	ARMRC058826101	Timer, 1-5 Sec., 250 VDC	MTGM500233-001
	ARMRC05882630-115	Timer, 2-10 Sec., 110 V, Armor	

OTIS

Armor Dynaglide (continued)

Image	Part Number	Description	Alt/Sub/Sup P/N
<i>Photo Not Available</i>	*ARMRC058826203	Timer, 5–40 Sec.	KONE504860500
<i>Photo Not Available</i>	*ARMRC05882630-109	Timer, 5–5 Sec., 110 V, Armor	

PC BOARDS

BAXCO

Image	Part Number	Description
<i>Photo Not Available</i>	*BXC01022	BHMC-10 Cont Board

OTIS





CEC

Modmaster / Swift 5000

Image	Part Number	Description	Alt/Sub/Sup P/N
<i>Photo Not Available</i>	CEC01594	256K X 8 Memory w/ RTC & Battery Backup	
	CEC01048	BW–Alpha Board, Lobby, Car or Machine Room	
<i>Photo Not Available</i>	CEC01825	Car 8825	CEC01225
	CEC01225	Car 8825 w/SBC 341	
	CEC01466	Car 8825 w/SBC 341, SBX 351	
	CEC01498	DAR-3 Board for Modmaster / Swift 5000	

© 2010, Otis Elevator Company (rev. November 2010)

PC BOARDS

Image	Part Number	Description	Alt/Sub/Sup P/N
<i>Photo Not Available</i>	*CEC01173	Diode Board	
	CEC01226	Group 8825	
<i>Photo Not Available</i>	CEC01418	Group 8825 w/SBC 341	
<i>Photo Not Available</i>	CEC01465	Group 8825 W/Sbc341, SBX 351	
<i>Photo Not Available</i>	CEC01107	GVI-3 Board for Modmaster / Swift 5000	
	CEC01150	PMI, 16 I/O, Unpopulated (Dover/CEC)	
	CEC01510	REG-3 Board for Modmaster / Swift 5000	
	CEC01292	RGB-Alpha	
	CEC01492	RTG-3 Board for Modmaster / Swift 5000	

OTIS

CEC Modmaster / Swift 5000 (continued)

Image	Part Number	Description	Alt/Sub/Sup P/N
<i>Photo Not Available</i>	CEC01290	SBC 341 Modified U6. Used for EEPROM.	
<i>Photo Not Available</i>	CEC01826	Serial Comm Mod RS-422, for CPU	
<i>Photo Not Available</i>	CEC01172	TOC Interface Board for Modmaster / Swift 5000	

Modmaster / Swift 5000 w/DSD 412 Drive

Image	Part Number	Description
<i>Photo Not Available</i>	CEC02090	DAR-3 Board, for Modmaster / Swift 5000 w/DSD 412

Swift 5000 CPU

Image	Part Number	Description
	CEC01827	SBC-18603a-03, Car / Group CPU, Swift 5000

Swift Futura

Image	Part Number	Description
	CEC02318	REG-3F2 Board. Used on Futura systems.
<i>Photo Not Available</i>	CEC02215	SEM

PC BOARDS

Swift Futura w/SCR Drive

©2010, Otis Elevator Company (rev. November 2010)

Image	Part Number	Description	Alt/Sub/Sup P/N
<i>Photo Not Available</i>	CEC02185	BKMF Power Board	



CEC02142M CPT Board for Futura w/SCR Drive

P/N CEC02142 Shown



CEC02147 EPU COP Board

<i>Photo Not Available</i>	CEC02167	EPU Link Board	
<i>Photo Not Available</i>	CEC02042	Futura SPU CPU Board	
<i>Photo Not Available</i>	CEC02148	HPU, Old Style	
<i>Photo Not Available</i>	CEC02183-R	Mod Interface	
<i>Photo Not Available</i>	CEC02186	Motor Field Control Board	
<i>Photo Not Available</i>	CEC02184	SMIC	
<i>Photo Not Available</i>	CEC02043	SPU Link Board	

OTIS

Swift Futura w/SCR Drive (continued)

Image	Part Number	Description	Alt/Sub/Sup P/N
	CEC02183	Universal I/O Board	CEC02183-R

© 2010, Otis Elevator Company (rev. November 2010)

PC BOARDS

Delta

Image	Part Number	Description	Alt/Sub/Sup P/N
	DELT01-1274	Driver Board	
<i>Photo Not Available</i>	DELT50-1274	Driver Board	DELT01-1274
<i>Photo Not Available</i>	DELT5049-00-0600	Traffic Analyzer Component (Part OFMT-128001)	
<i>Photo Not Available</i>	MT-128001	Traffic Analyzer—Delta 5049 Type	

OTIS



Dover

Composite

Image	Part Number	Description	Alt/Sub/Sup P/N
<i>Photo Not Available</i>	DOVR145557	Optical Leveling	DOVR9845550
<i>Photo Not Available</i>	DOVR9845550	Optical Leveling	DOVR9840266
<i>Photo Not Available</i>	DOVR9840266	Optical Leveling Conversion Kit	



PC BOARDS

DMC-I

Image	Part Number	Description	Alt/Sub/Sup P/N
<i>Photo Not Available</i>	DOVR141335	Auxiliary Sensor	DOVR9741331
<i>Photo Not Available</i>	DOVR9741331	Auxiliary Sensor	
<i>Photo Not Available</i>	DOVR6300CE2	Auxiliary Sensor	DOVR9741331
<i>Photo Not Available</i>	DOVR6300BP1	CLC Board	DOVR9841337
<i>Photo Not Available</i>	DOVR6300BP2	CLC Board	DOVR9841337
<i>Photo Not Available</i>	DOVR6300BP3	CLC Board	DOVR9841337
<i>Photo Not Available</i>	DOVR6300BP4	CLC Board	DOVR9715710
<i>Photo Not Available</i>	DOVR141336	CLC Board	DOVR9841337
<i>Photo Not Available</i>	DOVR141310	CLC Main Processor Board	DOVR9841337
	DOVR9715710	CLC Processor Board, New	
	DOVR9841337	CLC Processor Board, Old	
<i>Photo Not Available</i>	DOVR6300FX2	Door Board, DMC-I	DOVR6300FX3
<i>Photo Not Available</i>	DOVR6300FX4	Door Board, TAC 20	DOVR6300FX6
<i>Photo Not Available</i>	DOVR6300FX5	Door Operator Board, DMC-I HD85	DOVR9832439
<i>Photo Not Available</i>	DOVR6300PY2	Door Operator Board, DMC-I HD85	DOVR9832439
<i>Photo Not Available</i>	DOVR6300EH1	Door Operator Board, DMC-I HD85	DOVR9804134
<i>Photo Not Available</i>	DOVR9881323	Door Operator Board, DMC-I HD85	DOVR9804134
<i>Photo Not Available</i>	DOVR6300FX1	Door Operator Board, DMC-I HD85	DOVR6300FX3
<i>Photo Not Available</i>	DOVR6300FX3	Door Operator Board, DMC-I HD85	DOVR6300FX5
<i>Photo Not Available</i>	DOVR6300FX6	Door Operator Board, TAC 20	DOVR9832875
	DOVR9804134	Door Operator Processor Board, DMC-I HD85	DOVR6300FX3
<i>Photo Not Available</i>	DOVR6300DC5	I/O 2 CLC Expansion Board	DOVR9841453
<i>Photo Not Available</i>	DOVR141457	I/O Expansion Board	DOVR9841453

OTIS

Dover DMC-I (continued)

Image	Part Number	Description	Alt/Sub/Sup P/N
	DOVR9841453	I/O Expansion Board	
<i>Photo Not Available</i>	DOVR9841490	I/O Expansion Board	
<i>Photo Not Available</i>	DOVR9841465	I/O Expansion Board (Options)	
<i>Photo Not Available</i>	DOVR6300DC4	I/O Expansion Board (Options)	DOVR9841465
<i>Photo Not Available</i>	DOVR6300CD2	Main Sensor	DOVR9841325
	DOVR9841325	Main Sensor	
<i>Photo Not Available</i>	DOVR141329	Micro Door Operator	DOVR9804134
<i>Photo Not Available</i>	DOVR6300BJ13	Power Board, DMC-IA	DOVR9836494
	DOVR9841301	Power Relay Board	
<i>Photo Not Available</i>	DOVR6300BJ11	Power Relay Board	DOVR9841301
<i>Photo Not Available</i>	DOVR6300BJ7	Power Relay Board	DOVR9841301
<i>Photo Not Available</i>	DOVR9851379	Power Relay Board	DOVR9841301
<i>Photo Not Available</i>	DOVR6300BJ8	Power Relay Board	DOVR9851379
<i>Photo Not Available</i>	DOVR9841507	Power Supply, 5/12 VDC	
<i>Photo Not Available</i>	DOVR141305	Power Unit Relay Board	DOVR9851379
<i>Photo Not Available</i>	DOVR6300CV1	Selector	DOVR9841313
<i>Photo Not Available</i>	DOVR6300CV2	Selector	DOVR9841313
<i>Photo Not Available</i>	DOVR141317	Selector Board	DOVR9841313



© 2010, Otis Elevator Company (rev. November 2010)

PC BOARDS

©2010, Otis Elevator Company (rev. November 2010)

Image	Part Number	Description	Alt/Sub/Sup P/N
	DOVR9841313	Selector Processor Board	
<i>Photo Not Available</i>	DOVR141323	Sensor Board	DOVR9841325

Fixture

Image	Part Number	Description	Alt/Sub/Sup P/N
<i>Photo Not Available</i>	DOVR9713335	Digital PI Card, 7-Segment	
	DOVR118412	Emergency Light Board	DOVR9818420
	DOVR9818420	Emergency Light Board	
<i>Photo Not Available</i>	DOVR9830443	Logic, Board, 1.00 Dot Matrix PI	
<i>Photo Not Available</i>	DOVR9811382	PI Driver Power Board	DOVR9811370
<i>Photo Not Available</i>	DOVR9811370	PI Driver Power Board	
<i>Photo Not Available</i>	DOVR9814050	PI Interface	
<i>Photo Not Available</i>	DOVR113336	PI Readout Board	DOVR9713335
<i>Photo Not Available</i>	DOVR9713244	Power Logic Board 48 V	

OTIS



MMII

Image	Part Number	Description
<i>Photo Not Available</i>	DOVR9780210	Car Controller SBC 8825 Board
<i>Photo Not Available</i>	*DOVR9780087	Card, Top-of-Car Digitizer w/o Modules
	DOVR9780063	CPU, Car, SBC 8825 Board
<i>Photo Not Available</i>	*DOVR9780026	DAR-2 Board
<i>Photo Not Available</i>	*DOVR9829015	Expansion Board, SBC-341 PROM / RAM / EERAM
<i>Photo Not Available</i>	DOVR9780221	Master Board, SBX-351
<i>Photo Not Available</i>	DOVR9780038	Parallel I/O Board, PMI-16
<i>Photo Not Available</i>	*DOVR9780040	REG-2 Generator Field Regulator, 4 Quad Board
<i>Photo Not Available</i>	*DOVR9780051	RTG-3 Board
<i>Photo Not Available</i>	DOVR9780075	Slave Board, SBX-351
<i>Photo Not Available</i>	DOVR9780014	Video Card

© 2010, Otis Elevator Company (rev. November 2010)

PC BOARDS

MSC-I

Image	Part Number	Description	Alt/Sub/Sup P/N
	DOVR9813378	Decoder Board	
<i>Photo Not Available</i>	DOVR140483	Power	DOVR9880665
<i>Photo Not Available</i>	DOVR6300DP1	Power Board	DOVR9840485
	DOVR9840485	Power w/Plug-In Terminals	
<i>Photo Not Available</i>	DOVR9880665	Power w/Screw Terminals	
<i>Photo Not Available</i>	DOVR9840497	Regulator	
<i>Photo Not Available</i>	DOVR140490	Regulator, for Power Monitor	DOVR9840497
<i>Photo Not Available</i>	DOVR9781870	Relay, Reverse-Phase, for SPF Controllers	
<i>Photo Not Available</i>	DOVR9852943	Speed Pattern Board	
<i>Photo Not Available</i>	DOVR9740259	Tach Load Board	

Oilraulic

Image	Part Number	Description	Alt/Sub/Sup P/N
<i>Photo Not Available</i>	DOVR9805254	Option Board, 4 Slot	DOVR9753217
<i>Photo Not Available</i>	DOVR9753217	Option Board, 6 Slot	
	DOVR9855245	Power Board, 4 Slot	

OTIS

Solid State

Image	Part Number	Description	Alt/Sub/Sup P/N
	DOVR9855221	Car Board	
<i>Photo Not Available</i>	DOVR68179	Car Board, 3-Slot	DOVR9855221
<i>Photo Not Available</i>	DOVR123948	Car Board, 4-Slot	DOVR9855221
<i>Photo Not Available</i>	DOVR9881797	Car Hydro Board	DOVR9855221
	DOVR9855257	Card, Top and Bottom, 4-Slot	
<i>Photo Not Available</i>	DOVR124519	Door Board, 4-Slot	DOVR9855233
	DOVR9855233	Door Board	
<i>Photo Not Available</i>	DOVR9884336	Duplex Hydro Board, 3-Slot	
<i>Photo Not Available</i>	DOVR68432	Intermediate Board, 3-Slot	DOVR105252
<i>Photo Not Available</i>	DOVR105252	Intermediate Board, 4 Slot	DOVR9855269



© 2010, Otis Elevator Company (rev. November 2010)

PC BOARDS

Image	Part Number	Description	Alt/Sub/Sup P/N
	DOVR9855269	Intermediate, Hydro	
<i>Photo Not Available</i>	DOVR9781808	Logic Board, 3-Slot	
<i>Photo Not Available</i>	DOVR68525	Option Board, 3-Slot	DOVR105254
<i>Photo Not Available</i>	DOVR105254	Option Board, 4-Slot	DOVR9753217
<i>Photo Not Available</i>	DOVR68177	Power Board	DOVR105248
<i>Photo Not Available</i>	DOVR105248	Power Board, 4-Slot	DOVR9855245
<i>Photo Not Available</i>	DOVR68431	Top/Bottom Board, 3-Slot	DOVR105251
<i>Photo Not Available</i>	DOVR9825257	Top/Bottom Board, 4-Key	DOVR105251
<i>Photo Not Available</i>	DOVR105251	Top/Bottom Board, 4-Slot	DOVR9855257
<i>Photo Not Available</i>	DOVR66691	Top/Bottom Board, Hydro	DOVR105251

OTIS

Selector and Position Devices

Image	Part Number	Description	Alt/Sub/Sup P/N
	DOVR9811266	Leveling Control Board	DOVR9834140 DOVR9840266 DOVR9845550
<i>Photo Not Available</i>	DOVR9813779	LS1 Card	
<i>Photo Not Available</i>	DOVR9813720	LS5-HS Card	
<i>Photo Not Available</i>	DOVR9707918	LS6-HS T2	
<i>Photo Not Available</i>	DOVR112261	Optical Leveling Board	DOVR9811266
<i>Photo Not Available</i>	DOVR126125	Optical Leveling Board	DOVR9811266
	DOVR9834140	Optical Leveling Card	
<i>Photo Not Available</i>	DOVR9840138	Optical Leveling Sensor	
<i>Photo Not Available</i>	DOVR9812258	Optical Leveling Sensor, Dover Selector	DOVR9840138
<i>Photo Not Available</i>	DOVR6300FF1	Selector Leveling Board	DOVR9834140
<i>Photo Not Available</i>	DOVR6300FF2	Selector Leveling Board	DOVR9834140
<i>Photo Not Available</i>	DOVR9885213	Selector Leveling Board	DOVR9834140

© 2010, Otis Elevator Company (rev. November 2010)

PC BOARDS

T-I, T-II

Image	Part Number	Description
	DOVR9813937	ISS Card
<i>Photo Not Available</i>	DOVR9813949	ISP Card

T-II

Image	Part Number	Description	Alt/Sub/Sup P/N
<i>Photo Not Available</i>	DOVR9832154	Basic Control Motherboard	
<i>Photo Not Available</i>	DOVR9832487	Board Extension Connector, 44 Pin	
<i>Photo Not Available</i>	DOVR9832026	Call Card	
<i>Photo Not Available</i>	DOVR9832762	Clock Card	
<i>Photo Not Available</i>	DOVR9832373	Constant Current Source Card	
<i>Photo Not Available</i>	DOVR9732020	Control Mother Board	
<i>Photo Not Available</i>	DOVR9832786	CPU Card	
<i>Photo Not Available</i>	DOVR9832490	Extender Card, 100 Pin	
<i>Photo Not Available</i>	DOVR9832488	Extender Card, 44 Pin	
<i>Photo Not Available</i>	DOVR9832063	Field Half Bridge Card	
<i>Photo Not Available</i>	DOVR9832051	Generator Field Reg. Mother- board	
<i>Photo Not Available</i>	DOVR9833675	High Voltage I/O Card	
<i>Photo Not Available</i>	DOVR9833006	I/O Control Card	
<i>Photo Not Available</i>	DOVR9832075	I/O Decode Card	
<i>Photo Not Available</i>	DOVR9761627	I/O Input Card	
<i>Photo Not Available</i>	DOVR9728600	I/O Mother Board	
<i>Photo Not Available</i>	DOVR9762061	Loop Feedback Card	

	DOVR9813937	LSS Card
<i>Photo Not Available</i>	DOVR9813925	LSZ Card
<i>Photo Not Available</i>	LA46S2493-0020	Magnetic Board

OTIS

Dover TII (continued)

Image	Part Number	Description	Alt/Sub/Sup P/N
<i>Photo Not Available</i>	DOVR9762772	Parallel Card	
<i>Photo Not Available</i>	DOVR9833183	Reed Card	
<i>Photo Not Available</i>	DOVR9836007	Reed Card	
<i>Photo Not Available</i>	DOVR9832099	Relay Board	
<i>Photo Not Available</i>	DOVR9845148	Relay Card	
<i>Photo Not Available</i>	DOVR9762012	Relay Output Card	
<i>Photo Not Available</i>	DOVR9833432	RS-232 CPU Card	
<i>Photo Not Available</i>	DOVR9831757	RS-422 (DTE) Serial Card	
<i>Photo Not Available</i>	DOVR9822756	RS-422 CPU Card	
<i>Photo Not Available</i>	DOVR9764070	Serial Daticon Card	
<i>Photo Not Available</i>	DOVR9762218	Solid State Output Card	
<i>Photo Not Available</i>	DOVR9762073	Watchcard Card	

TII Selector & Position Devices

Image	Part Number	Description	Alt/Sub/Sup P/N
<i>Photo Not Available</i>	DOVR9732032	Loop Selector Motherboard	
<i>Photo Not Available</i>	DOVR9813779	LS1 Card	
<i>Photo Not Available</i>	DOVR9812568	LS10 Card	
<i>Photo Not Available</i>	DOVR9813755	LS2 Card	
<i>Photo Not Available</i>	DOVR9816306	LS3 Card	
<i>Photo Not Available</i>	DOVR9832956	LS4-S Card	
<i>Photo Not Available</i>	DOVR9813720	LS5-HS Card	
<i>Photo Not Available</i>	DOVR132566	LS8 Auxilliary Board, For TII & TIII	DOVR9812398
<i>Photo Not Available</i>	DOVR9812398	LS8 Card	
<i>Photo Not Available</i>	DOVR9812945	LS9 Card	
<i>Photo Not Available</i>	DOVR9813950	LSC Card	
<i>Photo Not Available</i>	DOVR9763004	Motor Field Regulator Card. For TII & TIII	

© 2010, Otis Elevator Company (rev. November 2010)



PC BOARDS

TIII

Image	Part Number	Description	Alt/Sub/Sup P/N
<i>Photo Not Available</i>	DOVR9853832	Communication Interface Board	
	DOVR9860289	CPU Car	
<i>Photo Not Available</i>	DOVR6300CT4	CPU Board	DOVR9860289
<i>Photo Not Available</i>	DOVR6300CT7	CPU Board	DOVR9860289
<i>Photo Not Available</i>	DOVR9860277	CPU Duplex	DOVR9840114
	DOVR9860253	CPU Duplex Board, Intel SBC-86/05A	
<i>Photo Not Available</i>	DOVR6300CT8	CPU Group	DOVR9860265
<i>Photo Not Available</i>	DOVR9860265	CPU Group	
	DOVR9853820	CPU Simplex Board, Intel SBC-86/05A	
<i>Photo Not Available</i>	DOVR9760027	DAR Board	
<i>Photo Not Available</i>	DOVR6300BL3	DDI Board	DOVR9841908
<i>Photo Not Available</i>	DOVR9841908	DDI Board	
<i>Photo Not Available</i>	DOVR6300BW1	ETSL Board	DOVR9860125
<i>Photo Not Available</i>	DOVR9860125	ETSL Card	

OTIS



Dover TIII (continued)

Image	Part Number	Description	Alt/Sub/Sup P/N
	DOVR9853686	Main Sensor	
<i>Photo Not Available</i>	DOVR6300AA1	Main Sensor	DOVR9853686
<i>Photo Not Available</i>	DOVR6300AA3	Main Sensor	DOVR9853686
<i>Photo Not Available</i>	*DOVR9853704	PMI 16 I/O Board	CEC01150
<i>Photo Not Available</i>	DOVR6300CN1	PMI 48	DOVR9863000
<i>Photo Not Available</i>	DOVR9881232	PMI 48 I/O, w/o Modules	
<i>Photo Not Available</i>	DOVR6300CN2	PMI-48	DOVR9881232
<i>Photo Not Available</i>	DOVR6300CN3	PMI-48 Board	DOVR9881359
<i>Photo Not Available</i>	DOVR9881359	PMI I/O 48 POS Board	
	DOVR9760052	REG Board	
<i>Photo Not Available</i>	DOVR9829805	REG Board	
<i>Photo Not Available</i>	DOVR6300AD2	REG Board	DOVR9760052
<i>Photo Not Available</i>	*DOVR6300AD5	REG Board	DOVR9829805
<i>Photo Not Available</i>	*DOVR6300AX1	ROM Expansion	
<i>Photo Not Available</i>	DOVR9714881	RTG Board	
<i>Photo Not Available</i>	*DOVR9853730	RTG Board	
<i>Photo Not Available</i>	DOVR6300AD4	RTG Board	DOVR9760052
<i>Photo Not Available</i>	DOVR6300AE2	SEL I/O	DOVR9853728
<i>Photo Not Available</i>	DOVR9853728	SEL I/O Assembly	
<i>Photo Not Available</i>	*DOVR9853741	Serial Communication Master	
<i>Photo Not Available</i>	*DOVR9853753	Serial Communication Slave	

© 2010, Otis Elevator Company (rev. November 2010)



PC BOARDS

TIII & TIV

Image	Part Number	Description	Alt/Sub/Sup P/N
<i>Photo Not Available</i>	DOVR6300ER5	CPU Board	DOVR9840114
	DOVR9840114	CPU Car	
<i>Photo Not Available</i>	DOVR6300ER4	CPU Car	DOVR9840114
<i>Photo Not Available</i>	DOVR6300CN4	PMI Board, 48 I/O	DOVR9863000
<i>Photo Not Available</i>	DOVR6300CN5	PMI Board, 48 I/O	DOVR9863000
	DOVR9863000	PMI Board, 48 I/O	
<i>Photo Not Available</i>	DOVR9853765	Video Board, Machine Room	
<i>Photo Not Available</i>	DOVR9853790	Video Car Diagnostic	
<i>Photo Not Available</i>	DOVR9853789	Video Control Panel	
<i>Photo Not Available</i>	DOVR9853777	Video Lobby Board	



OTIS

TIV

Image	Part Number	Description	Alt/Sub/Sup P/N
<i>Photo Not Available</i>	DOVR9816100	Backplane	
<i>Photo Not Available</i>	DOVR6300DL1	Bus Voltage Indicator Board	
<i>Photo Not Available</i>	DOVR6300CT9	CPU Board, Duplex	DOVR9860277
	DOVR9860290	CPU Board, Duplex	DOVR9840114
<i>(DOVR9840114 Pictured)</i>			
<i>Photo Not Available</i>	DOVR9716853	Current Regulator Board, Digital	
<i>Photo Not Available</i>	DOVR6300DE35	DSP Board. For TIV & TAC 50	DOVR9731817
	DOVR9731817	DSP Board. For TIV & TAC 50	
<i>Photo Not Available</i>	DOVR9841349	DSP-SCR ETSD Board	
<i>Photo Not Available</i>	DOVR6300DE10	DSP-SCR, ETSL Card	
<i>Photo Not Available</i>	DOVR9719490	DSP-VVVF ETSD Board	
<i>Photo Not Available</i>	DOVR6300DE12	DSP-VVVF.ETSL Card	
<i>Photo Not Available</i>	DOVR9716841	Gate Driver Board	

© 2010, Otis Elevator Company (rev. November 2010)

PC BOARDS

Image	Part Number	Description	Alt/Sub/Sup P/N
	DOVR9716830	HDW/Vector Control Board	
<p><i>Photo Not Available</i></p>	DOVR9843978	Inverter Snubber Board	
<p><i>Photo Not Available</i></p>	DOVR9718679	LEM Board	
<p><i>Photo Not Available</i></p>	DOVR9841600	Loadweigher CN.Board	
	DOVR9816392	QSR Board	

OTIS



Miscellaneous

Image	Part Number	Description	Alt/Sub/Sup P/N
	DOVR9816094	Car / Group Mother Board	
<i>Photo Not Available</i>	*DOVR6300BC1	Car Group CPU Board	
	DOVR9734612	Card REG	
<i>Photo Not Available</i>	DOVR9882534	CPU Card 80C186 Car, 16 MHz	DOVR9843991
	DOVR6300JC2	CPU Card, 16 MHz	
	DOVR9816975	Current Regulator Board	
	DOVR9832439	Door Operator Board, HD85	
<i>Photo Not Available</i>	DOVR113065	Double / Single Phase Rectifier	DOVR9892989
<i>Photo Not Available</i>	DOVR149355	Emergency Light	DOVR9839720

© 2010, Otis Elevator Company (rev. November 2010)

PC BOARDS

©2010, Otis Elevator Company (rev. November 2010)

Image	Part Number	Description	Alt/Sub/Sup P/N
	DOVR9839720	Emergency Light Board, 120 VAC	
<i>Photo Not Available</i>	DOVR9836494	Power Relay Board, DMC-I	
<i>Photo Not Available</i>	DOVR9830390	Power Supply	
<i>Photo Not Available</i>	DOVR9730394	Power Supply, Dot Matrix PI, 48 Volt	
	DOVR9782576	Processor, Main	
<i>Photo Not Available</i>	DOVR9879675	Rectifier Assembly, 3 Phase	
<i>Photo Not Available</i>	DOVR114129	Rectifier Board	DOVR9841246
<i>Photo Not Available</i>	DOVR9766170	Rectifier Board	
<i>Photo Not Available</i>	DOVR9892989	Rectifier Board	
<i>Photo Not Available</i>	DOVR9715289	Rectifier Board	
<i>Photo Not Available</i>	DOVR67967	Rectifier Board, 3 Amp PWA 110	DOVR9879675
<i>Photo Not Available</i>	DOVR9841246	Rectifier Board, 3 Phase, 3 Amp	
<i>Photo Not Available</i>	DOVR115298	Rectifier, 3 Phase, 6 Amp	DOVR9715289
<i>Photo Not Available</i>	DOVR6300ET1	Regulator Board, Low Arm. Volt. <360 Volts	DOVR9734612

OTIS

Dover Miscellaneous (continued)

Image	Part Number	Description	Alt/Sub/Sup P/N
	DOVR9852037	Timer, 120 VAC/DC (0.1-260 Seconds)	
	DOVR9833080	Timer, BRT	

© 2010, Otis Elevator Company (rev. November 2010)



FUJITEC

MIC 300

Image	Part Number	Description
<i>Photo Not Available</i>	FUJID05758003	Central Processor C1-CP27B, Millennium 2 Controller
<i>Photo Not Available</i>	FUJID05785001	Control Bk. Motor Field Millennium 1 Controller
<i>Photo Not Available</i>	FUJID05783002	COP EPU, Millennium 1 Controller
<i>Photo Not Available</i>	FUJID05783001	CPI EPU CC1/CC2, Millennium 1 Controller
<i>Photo Not Available</i>	FUJID05784001	CPT Comm. Distribution, Millennium 1 Controller
<i>Photo Not Available</i>	FUJID05787001	Hall Processing Unit, Millennium 1 Controller
<i>Photo Not Available</i>	FUJID99000056	HPB / HLL HPU SM, Millennium Controller
<i>Photo Not Available</i>	FUJID05759001	I/O Interface C1-IF56A, Millennium 2 Controller
<i>Photo Not Available</i>	FUJID05759004	I/O Interface C4-IF56A, Millennium 2 Controller
<i>Photo Not Available</i>	FUJID05759002	Interface C2-If56a, Millennium 2 Controller
<i>Photo Not Available</i>	FUJID05785002	Power Bk. Motor Field Millennium 1 Controller
<i>Photo Not Available</i>	FUJID05761001	Power Board C1-VS12, Millennium 2 Controller
<i>Photo Not Available</i>	FUJID05342001	PS-9 Board
<i>Photo Not Available</i>	FUJID05780010	SBX-414 ,12 Bit, Millennium 1 Controller
<i>Photo Not Available</i>	FUJID57810010	SMIM-1 System Interface Millennium 1 Controller
<i>Photo Not Available</i>	FUJID05780002	SPU Link Interface, Millennium 1 Controller
<i>Photo Not Available</i>	FUJID05780001	SPU Unit, Millennium 1 Controller
<i>Photo Not Available</i>	FUJID05342002	SR-15 Board

OTIS



Millennium

Image	Part Number	Description
	FUJID05338055	1M Slot Board CP9
	FUJID05338006	2M Slot Board 1P5C
	FUJID05338009	3M Slot Board 1P6A
<i>Photo Not Available</i>	FUJID05338011	4M Slot Board 1N10
<i>Photo Not Available</i>	FUJID05154001	AVR-1 Power Supply
<i>Photo Not Available</i>	FUJID05335005	AVR-2 Power Supply
	FUJID05338018	C1-1F26D Board
<i>Photo Not Available</i>	FUJID05278001	C1-PW1 Board

© 2010, Otis Elevator Company (rev. November 2010)

PC BOARDS

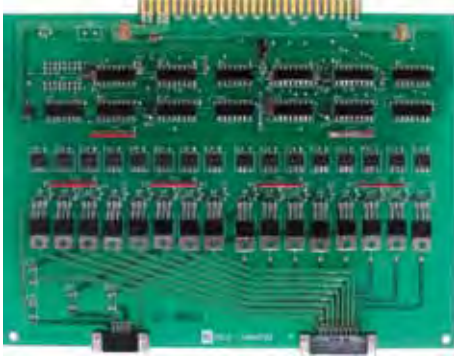
©2010, Otis Elevator Company (rev. November 2010)

Image	Part Number	Description
	FUJID05338020	C3-1F25D Board
	FUJID05143004	C4-1F25D Board
<i>Photo Not Available</i>	FUJID05338030	C4-1F27D Board
	FUJID05338012	C4-IN10 Board
<i>Photo Not Available</i>	FUJID05563001	C5-IF26E Board
<i>Photo Not Available</i>	FUJID99000100	C7-IF28C Board
<i>Photo Not Available</i>	FUJID05338093	Filter Module Board
	FUJID05342004	PG-11 Board

OTIS

Haughton

1092

Image	Part Number	Description	Application
<i>Photo Not Available</i>	HGTN3-40012-84	AGC	1092 IC
<i>Photo Not Available</i>	HGTN3-40261-38	Anti-Nuisance	1092 DR RJLX
<i>Photo Not Available</i>	HGTN3-40012-76	Car Button Board	1092 IC
<i>Photo Not Available</i>	HGTN3-40250-21E	Car Control	1092 DR RJLX
<i>Photo Not Available</i>	HGTN3-40250-21	Car Control Board	1093 DR RJLX
<i>Photo Not Available</i>	*HGTN3-40250-06	Car Position	1092 DR RJLX
<i>Photo Not Available</i>	HGTN3-40012-91	CAS1	1092 IC
<i>Photo Not Available</i>	HGTN3-40012-27	CAS2	1092 IC
<i>Photo Not Available</i>	HGTN3-40012-68	CAS3	1092 IC
<i>Photo Not Available</i>	HGTN3-40012-62	CBUFF	1092 IC
<i>Photo Not Available</i>	HGTN3-40012-63	CBUFF	1092 IC
<i>Photo Not Available</i>	HGTN3-40012-58	CCB	1092 IC
<i>Photo Not Available</i>	HGTN3-40012-23	Contact Buffer Board	1092 IC
<i>Photo Not Available</i>	HGTN3-40012-70	CQC1	1092 IC
<i>Photo Not Available</i>	HGTN3-40012-20	CSC1	1092 IC
<i>Photo Not Available</i>	HGTN3-40012-34	CSC2	1092 IC
<i>Photo Not Available</i>	HGTN3-40012-95	Door Timing Board	1092 IC
<i>Photo Not Available</i>	HGTN3-40012-37	Driver Output Buffer Board	1092 IC
<i>Photo Not Available</i>	HGTN3-40012-29	DTM	1092 IC
<i>Photo Not Available</i>	HGTN3-40254-57	Excess Calls	1092 DR RJLX
<i>Photo Not Available</i>	HGTN3-40012-78	FSM	1092 IC
<i>Photo Not Available</i>	HGTN3-40233-72B	General Control	1092 DR RJLX
<i>Photo Not Available</i>	HGTN3-40289-89D	Generator Board, Gearless	1092 MC SAM & GAM
<i>Photo Not Available</i>	HGTN3-40289-89	Generator Board, Hydro	1092 MC SAM & GAM
<i>Photo Not Available</i>	HGTN3-40239-26	Hall Call Buffer Car A	1092 DR RJLX
<i>Photo Not Available</i>	HGTN3-40239-36	Hall Call Position Buffer	1092 DR RJLX
<i>Photo Not Available</i>	HGTN3-40012-69	HCM	1092 IC
<i>Photo Not Available</i>	HGTN3-40307-23	I/O Buffer Board	1092DRM
<i>Photo Not Available</i>	HGTN3-40012-90	Interface Control Board	1092 IC
<i>Photo Not Available</i>	HGTN3-40012-85	ITC	1092 IC
<i>Photo Not Available</i>	HGTN3-40012-72	Light Driver Board	1092 IC
<i>Photo Not Available</i>	HGTN3-40012-93	LRC	1092 IC
<i>Photo Not Available</i>	HGTN3-40012-28	MBS1	1092 IC
<i>Photo Not Available</i>	HGTN3-40012-33	MBS2	1092 IC
<i>Photo Not Available</i>	HGTN3-40012-92	MGC	1092 IC

PC BOARDS

©2010, Otis Elevator Company (rev. November 2010)

Image	Part Number	Description	Application
<i>Photo Not Available</i>	HGTN3-40012-01	MRC1	1092 IC
<i>Photo Not Available</i>	HGTN3-40012-74	MRC1 (Ring Counter Master Board #1)	1092 IC
<i>Photo Not Available</i>	HGTN3-40230-10	Optical Leveling Switch	1092 SAM & GAM
<i>Photo Not Available</i>	HGTN3-40012-24	Output Buffer Board	1092 IC
<i>Photo Not Available</i>	HGTN3-40250-02	Parking Board	1092 DR RJLX
<i>Photo Not Available</i>	HGTN3-40250-02F	Parking Board	1092 DR RJLX
<i>Photo Not Available</i>	HGTN3-40012-64	PB2	1092 IC
<i>Photo Not Available</i>	HGTN3-40012-89	PBBH	1092 IC
<i>Photo Not Available</i>	*HGTN3-40250-26	Position Hall Call Buffer Board (alternate p/n HGTN3-40239-36)	1092 DR RJLX
<i>Photo Not Available</i>	HGTN3-40250-31	Power Supply, 12 Volt	1092 DR RJLX
<i>Photo Not Available</i>	HGTN3-40012-99	Provision Board	1092 IC
<i>Photo Not Available</i>	HGTN3-40005-27	Pulse Generator	1092 MC SAM & GAM, ACCUFLITE
<i>Photo Not Available</i>	*HGTN3-40005-26	Pulse Generator	1092 SAM & GAM
<i>Photo Not Available</i>	HGTN3-40012-80	QI	1092 IC
<i>Photo Not Available</i>	HGTN3-40266-43	Relay Driver, 64 Floors	1092 SAM & GAM
<i>Photo Not Available</i>	HGTN3-40012-55	RSC	1092 IC
<i>Photo Not Available</i>	HGTN3-40261-89	SAM Interface	1092 SAM & GAM
<i>Photo Not Available</i>	HGTN3-40012-83	SC	1092 IC
<i>Photo Not Available</i>	HGTN3-40012-06	SCRN1 (Select Ring Counter #1)	1092 IC
<i>Photo Not Available</i>	HGTN3-40012-79	SDS	1092 IC
<i>Photo Not Available</i>	HGTN3-40012-06	SRCN2	1092 IC

OTIS

Accuflite

Image	Part Number	Description	Alt/Sub/Sup P/N
<i>Photo Not Available</i>	HGTN3-40252-30	Amplifier Board	
<i>Photo Not Available</i>	HGTN3-40254-04	Fail Detection Board	
<i>Photo Not Available</i>	HGTN3-40008-56	Failure Detector	
<i>Photo Not Available</i>	HGTN3-40006-55	Input Buffer	HGTN3-40289-46
<i>Photo Not Available</i>	HGTN3-40008-80	Pattern Gen	
<i>Photo Not Available</i>	HGTN3-40006-59	Position Interface	

Dynatron GAC IV

Image	Part Number	Description
<i>Photo Not Available</i>	HGTN3-40287-93B	Amplifier Board, GAC IV
<i>Photo Not Available</i>	HGTN3-40287-97	Braking Board, Oh Machine, Dynatron GAC IV
<i>Photo Not Available</i>	HGTN3-40231-47C	EK Machine Braking Board
<i>Photo Not Available</i>	HGTN3-40287-89	Pattern Board, GAC IV

OTIS

Electronic Stepping Switch

Image	Part Number	Description	Alt/Sub/Sup P/N
<i>Photo Not Available</i>	HGTN3-40233-56	Stepper Mother Board, 24 Volt	
<i>Photo Not Available</i>	HGTN3-40233-63	Stepper Relay Board	HGTN3-40324-87
<i>Photo Not Available</i>	HGTN3-40324-87	Stepper Switch, Electronic	
<i>Photo Not Available</i>	HGTN3-40233-59B	Stepping Switch Mother Board, 120 Volt	HGTN3-40233-59
<i>Photo Not Available</i>	HGTN3-40233-59	Stepping Switch Mother Board. 120 Volt	

Escalator



Image	Part Number	Description
<i>Photo Not Available</i>	HGTN3-40220-54B	Emergency Light Board and Battery

EVC, ELC

Image	Part Number	Description
<i>Photo Not Available</i>	*HGTN3-40179-87	ELC Leveling Control Board



PC BOARDS

Goldflight

Image	Part Number	Description	Alt/Sub/Sup P/N	Application
	HGTN3-40280-14	Accessory Board		Goldflight
<i>Photo Not Available</i>	*HGTN3-40290-10C	Amplifier Board	HGTN3-40290-10F	Goldflight
<i>Photo Not Available</i>	HGTN3-40290-10	Amplifier Board		Goldflight
<i>Photo Not Available</i>	HGTN3-40290-10F	Amplifier Board		Goldflight
	HGTN3-40281-60	Amplifier Board, Geared S6R/GDC		Goldflight DC
<i>Photo Not Available</i>	HGTN3-40281-95	Amplifier Board, Gearless S6R		Goldflight DC
	HGTN3-40283-10	Amplifier, GAC		Goldflight GAC
<i>Photo Not Available</i>	HGTN3-40259-45	Counter Board		Goldflight

OTIS

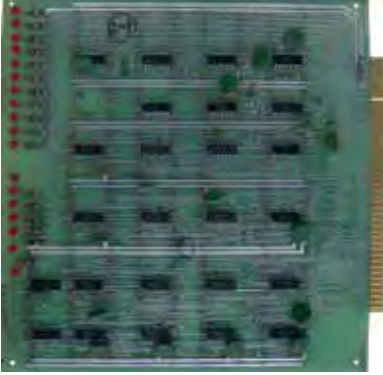



Haughton Goldflight (continued)

Image	Part Number	Description	Alt/Sub/Sup P/N	Application
	HGTN3-40259-45A	Counter Board		Goldflight
<i>Photo Not Available</i>	*HGTN3-40005-04	Counter C	HGTN3-40259-45	Goldflight
<i>Photo Not Available</i>	HGTN3-40005-05	Counter C		Goldflight
<i>Photo Not Available</i>	*HGTN3-40261-81	Data Priority		Goldflight
	HGTN3-40292-28	Data Priority	HGTN3-40292-28B	Goldflight
<i>Photo Not Available</i>	HGTN3-40292-28B	Data Priority		Goldflight
<i>Photo Not Available</i>	HGTN3-40292-28C	Data Priority		Goldflight
<i>Photo Not Available</i>	HGTN3-40332-63B	EA2232MA Call Input and Lamp Driver		Goldflight
<i>Photo Not Available</i>	HGTN3-40332-65	EK Board, Miconic V		Goldflight
<i>Photo Not Available</i>	*HGTN3-40277-78B	GMG Amp Board	HGTN3-40281-07	Goldflight
<i>Photo Not Available</i>	*HGTN3-40281-06	GMG Amp Board, for Geared and Gearless	HGTN3-40281-07	Goldflight MG

© 2010, Otis Elevator Company (rev. November 2010)

PC BOARDS

©2010, Otis Elevator Company (rev. November 2010)

Image	Part Number	Description	Alt/Sub/Sup P/N	Application
	HGTN3-40281-07	GMG Amp Board, for Geared and Gearless		Goldflight MG
<i>Photo Not Available</i>	HGTN3-40280-33	Heat Sink Assembly (LV), Dynatron CAC	HGTN3-40280-34	Goldflight GAC
	HGTN3-40280-34	Heat Sink Assembly GAC		Goldflight GAC
	HGTN3-40261-85	Input Priority		Goldflight
	HGTN3-40271-69	Input Priority Board		Goldflight

OTIS



Haughton Goldflight (continued)

Image	Part Number	Description	Alt/Sub/Sup P/N	Application
<i>Photo Not Available</i>	HGTN3-40271-69B	Input Priority Board		Goldflight
<i>Photo Not Available</i>	*HGTN3-40292-32	Interface, Goldflight SAM/GAM Board		Goldflight
	HGTN3-40292-32D	Interface, Goldflight SAM/GAM Board		Goldflight
<i>Photo Not Available</i>	HGTN3-40290-19	Loop Monitor Board		Goldflight
<i>Photo Not Available</i>	*HGTN3-40277-03B	Memory Board 64 Stop		Goldflight
<i>Photo Not Available</i>	*HGTN3-40277-03C	Memory Board 64 Stop		Goldflight
<i>Photo Not Available</i>	HGTN3-40277-03	Memory Board 64 Stop		Goldflight
<i>Photo Not Available</i>	HGTN3-40005-02	Memory Board, for 1092 MC SAM/GAM		Goldflight
<i>Photo Not Available</i>	*HGTN3-40005-01	Memory D	HGTN3-40277-03	Goldflight
<i>Photo Not Available</i>	HGTN3-40256-98	Pattern Board		Goldflight
<i>Photo Not Available</i>	HGTN3-40283-07	Pattern Gen, GAC		Goldflight DC
<i>Photo Not Available</i>	*HGTN3-40256-73	Pattern Generator Board		Goldflight
<i>Photo Not Available</i>	HGTN3-40267-48F	Pattern Generator Board	HGTN3-40267-48	Goldflight
<i>Photo Not Available</i>	HGTN3-40280-81	Pattern Generator Board	HGTN3-40280-81E	Goldflight
<i>Photo Not Available</i>	HGTN3-40280-81E	Pattern Generator Board	HGTN3-40280-81	Goldflight

© 2010, Otis Elevator Company (rev. November 2010)

PC BOARDS

©2010, Otis Elevator Company (rev. November 2010)

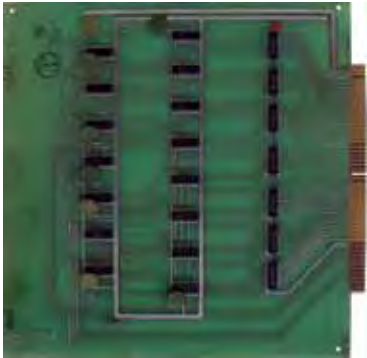
Image	Part Number	Description	Alt/Sub/Sup P/N	Application
	HGTN3-40280-97	Position I/O Board		Goldflight
	HGTN3-40280-85	Predictor Board		Goldflight
<i>Photo Not Available</i>	HGTN3-40280-85C	Predictor Board		Goldflight
	HGTN3-40264-47	Relay Driver Board		Goldflight
<i>Photo Not Available</i>	HGTN3-40284-28	Reverse Phase		Goldflight GAC

OTIS

Haughton Goldflight (continued)

Image	Part Number	Description	Alt/Sub/Sup P/N	Application
	HGTN3-40267-48	S6R Pattern Gen Board		Goldflight
	HGTN3-40280-89	Sam Motor Field Control Board		Goldflight
	HGTN3-40289-46	SAM/ GAM I/O Buffer Board		Goldflight
<i>Photo Not Available</i>	HGTN3-40008-53	System Control Board		Goldflight

© 2010, Otis Elevator Company (rev. November 2010)

PC BOARDS

Image	Part Number	Description	Alt/Sub/Sup P/N	Application
<i>Photo Not Available</i>	*HGTN3-40280-18F	Timer Board	HGTN3-40280-18	Goldflight MG
	HGTN3-40280-18	Timer Board		Goldflight

OTIS

Hydro

Image	Part Number	Description
<i>Photo Not Available</i>	HGTN3-40287-87	Auxiliary Board
<i>Photo Not Available</i>	HGTN3-40267-66	Hydro A Board
<i>Photo Not Available</i>	HGTN3-40267-70	Hydro B Board

Miconic

Image	Part Number	Description	Alt/Sub/Sup P/N	Application
<i>Photo Not Available</i>	HGTN3-40233-09	Amplifier, for Truflite EVCR		Miconic V
<i>Photo Not Available</i>	HGTN3-40290-59	Current and Voltage Transducer CVTG	RELI0-51831-6	Miconic V
<i>Photo Not Available</i>	*HGTN3-40254-93	Current Loop Driver	HGTN0-51865-1	Miconic V
<i>Photo Not Available</i>	*HGTN3-40254-94	GDCB Board		Miconic TX
<i>Photo Not Available</i>	*HGTN3-40332-84	Heat Sink Assembly, 250 Amps		Miconic V
<i>Photo Not Available</i>	*HGTN3-40332-85	Heat Sink Assembly, 350 Amps		Miconic V
<i>Photo Not Available</i>	HGTN3-40315-37	Loadweigh		Miconic VM
<i>Photo Not Available</i>	HGTN3-40332-57D	MPSZ Board		Miconic V
<i>Photo Not Available</i>	HGTN3-40332-56	PAL-216MA Board	HGTN3-40333-48	Miconic V
<i>Photo Not Available</i>	HGTN3-40333-48	PAL-216MA Board		Miconic V
<i>Photo Not Available</i>	HGTN3-40233-13	Pattern Board, for Truflite EVCR		Miconic V
<i>Photo Not Available</i>	HGTN3-40332-60	PEC Board		Miconic V
<i>Photo Not Available</i>	HGTN3-40255-30	PRSC Board, Static Drive Cards		Miconic V
<i>Photo Not Available</i>	HGTN3-40332-38	Pulse Tach (LG500Q)		Miconic V
<i>Photo Not Available</i>	HGTN3-40290-58	Static Sequencing and Control Card SSCC	RELI0-51874-2	Miconic V
<i>Photo Not Available</i>	HGTN3-40332-61	SUA Board		Miconic V
<i>Photo Not Available</i>	HGTN3-40332-66	THYM Board		Miconic V
<i>Photo Not Available</i>	HGTN3-40332-59D	UVPN 512Ma Power Supply Board		Miconic V
<i>Photo Not Available</i>	HGTN3-40332-62	VSR Board		Miconic V

PC BOARDS

Static Drives Reliance Cards

Image	Part Number	Description	Alt/Sub/Sup P/N
<i>Photo Not Available</i>	HGTN3-40255-28	CLDB Board	
	*HGTN0-51865-1	CLDB Gate Driver Board	
<i>Photo Not Available</i>	*HGTN3-40255-26	CV-TD Board	HGTN0-51831-3
	HGTN0-51831-3	CVTD Module	
<i>Photo Not Available</i>	HGTN3-40290-62	DFSA Board	RELI0-52823
	HGTN0-51849-1	GDCB	
	HGTN3-40318-72	Heat Sink Assembly	
	HGTN0-51839-7	IRCH - Reliance Drive Board	HGTN3-40255-27
<i>Photo Not Available</i>	*HGTN3-40255-27	IRCH Card	
<i>Photo Not Available</i>	HGTN3-40290-60	Overload and Voltage Comparator, OLVC	RELI0-52808
<i>Photo Not Available</i>	HGTN0-51845-2	PRSC-GDCB Assembly	

OTIS

Haughton Static Drives Reliance Cards (continued)

Image	Part Number	Description	Alt/Sub/Sup P/N
	HGTN3-40255-50	S6R High Voltage Heat Sink 86466-18S	HGTN3-40318-72
<i>Photo Not Available</i>	HGTN0-51874	SSCA	
<i>Photo Not Available</i>	*HGTN3-40255-49	Static Drive Reliance Heat Sink 86466-18R	HGTN3-40255-50
<i>Photo Not Available</i>	*HGTN3-40318-71	Static Drive Reliance Heat Sink Assembly	
<i>Photo Not Available</i>	*HGTN3-40254-46	Static Sequence Card	HGTN0-51874
<i>Photo Not Available</i>	HGTN0-51874-2	Static Sequencing and Control Card (SSCC)	HGTN3-40290-58

© 2010, Otis Elevator Company (rev. November 2010)



PC BOARDS

Miscellaneous

Image	Part Number	Description	Alt/Sub/Sup P/N	Application
<i>Photo Not Available</i>	HGTN3-40012-12	56-Pin Board		Model V, 1092IC
<i>Photo Not Available</i>	HGTN3-40246-69	Amplifier		Model V
<i>Photo Not Available</i>	HGTN3-40143-01	Amplifier Board		Model III, IV, EVC, ELC
<i>Photo Not Available</i>	HGTN3-40229-94	Amplifier Board		Model V
<i>Photo Not Available</i>	*HGTN3-40229-95	Amplifier Board	HGTN3-40246-69	Model V
<i>Photo Not Available</i>	HGTN3-40231-72B	CFC GAM Board		SAM / GAM / 1092 MCM / 1092 DRM
<i>Photo Not Available</i>	HGTN3-40340-01	CLRC-1 Board	HGTN3-40340-02	S9RFM
<i>Photo Not Available</i>	HGTN3-40340-02	CLRC-2 Board		S9RFM
<i>Photo Not Available</i>	HGTN3-40008-21	Emergency Light- ing		Misc.
<i>Photo Not Available</i>	HGTN3-40222-59E	EVC Pattern Gen- erator, Mark V		Model IV
<i>Photo Not Available</i>	HGTN3-40162-07	Excess Error Board		Model I, III, IV
<i>Photo Not Available</i>	*HGTN3-40221-95	Fail Det Board	HGTN3-40221-96	Model V
<i>Photo Not Available</i>	HGTN3-40221-96	Fail Det Board		Model V
<i>Photo Not Available</i>	HGTN3-40254-91	Failure Detection Board		Model V, EVC, ELC
<i>Photo Not Available</i>	HGTN3-40229-96	Failure Detector		Model V
	HGTN3-40229-98	Failure Detector		Model V
<i>Photo Not Available</i>	HGTN3-40285-60	Failure Indicator Board		SW Escalator
<i>Photo Not Available</i>	HGTN3-40155-92	High Voltage Board		Model II, III, IV
<i>Photo Not Available</i>	HGTN3-40266-40	Interface Card HIC		S6RFM
<i>Photo Not Available</i>	HGTN3-40143-00	Level Decoder Board		Model I, II, III
<i>Photo Not Available</i>	HGTN3-40179-99	Leveling Control Board		Model V

OTIS

Haughton Miscellaneous (continued)

Image	Part Number	Description	Alt/Sub/Sup P/N	Application
	HGTN3-40181-58	Leveling Switch Decoder Board		Model IV
<i>Photo Not Available</i>	HGTN3-40231-70	Microprocessor		SAM / GAM / 1092 MCM / 1092 DRM
<i>Photo Not Available</i>	HGTN3-40221-73	Mother Board		Model V
	HGTN3-40142-97	Pattern Gen Board		Model I, III
<i>Photo Not Available</i>	HGTN3-40181-91	Pattern Gen Board		Model IV
<i>Photo Not Available</i>	HGTN3-40223-13	Pattern Generator, Model V		Model IV
<i>Photo Not Available</i>	HGTN3-40143-03	Power Supply As- sembly Mod 3		Model I, II, III, IV
<i>Photo Not Available</i>	*HGTN3-40020-51	Predictor Board		Model III, IV, V
<i>Photo Not Available</i>	HGTN3-40320-63	RCE Interface Board (Stepper)		RCE PI
<i>Photo Not Available</i>	*HGTNW-002	SBC-88-25		
<i>Photo Not Available</i>	HGTN3-40142-99	SCR Assembly Mod 3		Model III, IV, EVC, ELC
	HGTN3-40143-02	SCR Trigger Moni- tor Board		Model III, IV, V
<i>Photo Not Available</i>	HGTN3-40224-27	Timer Board As- sembly		Misc.
<i>Photo Not Available</i>	*HGTN3-40221-64	V EVC Amplifier Board	HGTN3-40246-69	Model III, IV, V

© 2010, Otis Elevator Company (rev. November 2010)

PC BOARDS

KONE

KCM 831

Image	Part Number	Description	Alt/Sub/Sup P/N
<i>Photo Not Available</i>	KONEKM762710G01	Hall FLR Board	
<i>Photo Not Available</i>	KONEKM935697G01	LCE ADON Kit Board	
<i>Photo Not Available</i>	KONEKM935697G02	LCE ADON Kit Board	
<i>Photo Not Available</i>	KONEKM773380G02	LCE CPU	KONEKM773380G04
<i>Photo Not Available</i>	KONEKM773380G04	LCE CPU	
<i>Photo Not Available</i>	KONEKM760310G01	LCE DRV	
<i>Photo Not Available</i>	KONEKM713180G01	LCE GTW Board	
<i>Photo Not Available</i>	KONEKM762720G01	LCE MCU	KONEKM762720G02
<i>Photo Not Available</i>	KONEKM762720G02	LCE MCU	
<i>Photo Not Available</i>	KONEKM713150G01	LCE Option Board	
<i>Photo Not Available</i>	KONEKM713140G08	LCE REC Board	
<i>Photo Not Available</i>	KONEKM713140G09	LCE REC Board	

OTIS

TMS 900

Image	Part Number	Description	Alt/Sub/Sup P/N
<i>Photo Not Available</i>	KONE353621G01	Board	MTGM515877
<i>Photo Not Available</i>	KONE55063G01	Board	MTGM516304
<i>Photo Not Available</i>	KONE516361	Board US516361	
<i>Photo Not Available</i>	KONE354955G01	Buss Adapter Module Board	
<i>Photo Not Available</i>	KONE160154G02	Communication RS-422 Board	
	KONE57212G04	Controller Board	
<i>Photo Not Available</i>	KONE357290G02	CPU-88 Computer Board	MTGM516463
<i>Photo Not Available</i>	KONEB0580704-01	Current Brake/Field Board	ARMR058-8502-01
<i>Photo Not Available</i>	KONEB0588502-01	Current Brake/Field Board	ARMR058-8502-01
<i>Photo Not Available</i>	KONE140252G07	Current Regulator	
<i>Photo Not Available</i>	KONE516196	Current Regulator	KONE140252G07
<i>Photo Not Available</i>	KONE140216G02	Firing Card	MTGM518240
<i>Photo Not Available</i>	KONE55007G04	Floor Module	
<i>Photo Not Available</i>	KONE55007G01	Floor Module Board	
<i>Photo Not Available</i>	KONE515611	I/O Module Board	KONE55011G02
<i>Photo Not Available</i>	KONE55011G01	I/O Module Board	MTGM515611
<i>Photo Not Available</i>	KONE55011G02	I/O Module Board	
<i>Photo Not Available</i>	KONE515710	Interface Board	
<i>Photo Not Available</i>	KONE516307	Interface Board	KONE55079G02
<i>Photo Not Available</i>	KONE55079G01	Interface Board	KONE515710
<i>Photo Not Available</i>	KONE55079G02	Interface Board	
<i>Photo Not Available</i>	KONE55031G04	Matrix Board	KONE515567
<i>Photo Not Available</i>	KONE165816G01	MEM-88 Board	KONE516361
<i>Photo Not Available</i>	KONE165816G02	MEM-88 Board	
<i>Photo Not Available</i>	KONE165816G03	MEM-88 Board	





PC BOARDS

©2010, Otis Elevator Company (rev. November 2010)

Image	Part Number	Description	Alt/Sub/Sup P/N
<i>Photo Not Available</i>	KONE371021G01	MEM-88 Board	KONE514975
<i>Photo Not Available</i>	KONE157103G02	Power Supply Board	MTGM515779
<i>Photo Not Available</i>	KONE165812G01	Power Supply Board	MTGM515569
<i>Photo Not Available</i>	KONE515635	Pulse Counter Board	MTGM515635
<i>Photo Not Available</i>	KONE160616G01	Pulse Counter Board PCNTR-81	KONE160616G02
<i>Photo Not Available</i>	KONE160616G02	Pulse Counter Board PCNTR-81	MTGM515635
<i>Photo Not Available</i>	KONE166442G01	Receiver Board	
<i>Photo Not Available</i>	KONE55059G01	REG-80 Board	
<i>Photo Not Available</i>	KONE140252G04	Regulator Board	
	KONE515572	Relay In Board	
<i>Photo Not Available</i>	KONE515620	Relay Output Board	KONE55019G03
<i>Photo Not Available</i>	KONE55019G03	Relay Output Board	
<i>Photo Not Available</i>	KONE518244	SCD Speed Regulator Board	
<i>Photo Not Available</i>	KONE514975	SD Board, Armor	
<i>Photo Not Available</i>	KONE166624G02	Speed Control Board	KONE516364
<i>Photo Not Available</i>	KONE516364	Speed Control Board	
<i>Photo Not Available</i>	KONE140352G01	Speed Reference Board	KONE518244
<i>Photo Not Available</i>	KONE166628G01	Speed Refer- ence Board A6A6 4TMS900	MTGM515568
<i>Photo Not Available</i>	KONE140352G02	Speed Regulator Board	MTGM515699
<i>Photo Not Available</i>	KONE140236G02	Supervision Board	
<i>Photo Not Available</i>	KONE140383G02	Supervision SCD Rack Board	MTGM515830
<i>Photo Not Available</i>	KONE140247G01	Test Board SCD Rack	MTGM515995
<i>Photo Not Available</i>	KONE140202G01	Transformer Pulse Board	MTGM515570
<i>Photo Not Available</i>	KONE357294G01	XIO-88 Board	

OTIS

MCE

Image	Part Number	Description	Alt/Sub/Sup P/N	Application
	MCECMC-PC-1	Board MC-PC-1 Program Control Board		
<i>Photo Not Available</i>	MCECHC-CI/0 REV3	Call Board	MCECHC-CI/0 REV4	
<i>Photo Not Available</i>	MCECHC-CI/0 REV4	Call Board		
<i>Photo Not Available</i>	MCECHC-CI/0	Call I/O		
<i>Photo Not Available</i>	MCECHC-RPSDB	Door Power Supply Board		
	MCECHC-CI/0N	HC-C I/O N Board		
	MCECHC-I/0X	HC-I/OX Expander Board		VVMC-1000
	MCECHC-PCI0	HC-PC-I/O Power and Call Board Combined		
<i>Photo Not Available</i>	MCECHC-PIX	HC-PIX PI Board		
	MCECHC-PIX-16	HC-PIX PI Board		

© 2010, Otis Elevator Company (rev. November 2010)

PC BOARDS

©2010, Otis Elevator Company (rev. November 2010)

Image	Part Number	Description	Alt/Sub/Sup P/N	Application
<i>Photo Not Available</i>	MCECHC-I40	I/O Expander Board, 16 in and 4 out		
	MCECHC-PI/0	Input/ Output HC-PI/ O Board		VVMC- 1000
	MCECHC-CI/0-1B	Input/Output	MCECHC-CI/0	VVMC- 1000
	MCECHC-CI/0-1A	Input/Output	MCECHC-CI/0	
	MCECHC-PI/0-1B	Input/Output HC-PI/O		
<i>Photo Not Available</i>	MCECHC-PI/0-1C	Input/Output HC-PI/O	MCECHC-PI/0	
	MCECHC-IPLS	Landing System Board		
<i>Photo Not Available</i>	MCECMC-MP-1ES	Main Microprocessor Board		
<i>Photo Not Available</i>	MCECMC-MP	Main Processor Board		
<i>Photo Not Available</i>	*MCECMC-MP-1	Main Processor Board		
<i>Photo Not Available</i>	MCECHC-CI/0-E	MCE Board		
<i>Photo Not Available</i>	MCECHC-CI/0-L	MCE Board		

OTIS



MCE (continued)

Image	Part Number	Description	Alt/Sub/Sup P/N	Application
	MCECHC-DFLS	MCE DF Landing Systems Board		
<i>Photo Not Available</i>	MCECHC-DFLS-TR	MCE DF Landing Systems Board		
	MCECHC-DB-M0D	Mod Door Operator Board		
	MCECMC-PCA-0A	Motion Controls PCA Board		
<i>Photo Not Available</i>	MCECMC-PA	Perip Adapt Board, 2 Ports		
	MCECHC-PCI0-L	Power-Call I/O Board, Low Voltage		
	MCECSCR-PRI-ENH	Relay Interface Board	MCECSCR-PRI-EE	
<i>Photo Not Available</i>	MCECSCR-PRI-EE	SCR Power Relay Interface Board		

© 2010, Otis Elevator Company (rev. November 2010)

PC BOARDS



Millar

Image	Part Number	Description	Application
<i>Photo Not Available</i>	*MILRPWB-1004	Analog Isolation Amplifier Board	
<i>Photo Not Available</i>	MILR3-40392-56	CPU Board	CVT AI 2400
	MILR3-40393-54	I/O Board	
	MILR-SBC-519-KIT	I/O Board Kit, Multi-Bus, Millar/ Westinghouse	
	MILR-SBC-519	I/O Board, Millar and Microscan	

OTIS

Montgomery

Door

Image	Part Number	Description
	MTGMP-31872-003	105 Door Board, Closed Loop
	MTGMP-31729-005	Marathon Door Operator Board WG Closed Loop

© 2010, Otis Elevator Company (rev. November 2010)

Escalator

Image	Part Number	Description	Alt/Sub/Sup P/N
<i>Photo Not Available</i>	MTGMP-31787-001	Escalator PCB	
<i>Photo Not Available</i>	MTGMP-31787-004	Escalator PCB	
<i>Photo Not Available</i>	MTGMP-32302-002	E-5000 CPU Board	MTGMP-32302-003S MTGMP-32302-003HR
<i>Photo Not Available</i>	MTGMP-32302-003S	E-5000 CPU Board	
<i>Photo Not Available</i>	MTGMP-32302-003HR	E-5000 CPU Board	
<i>Photo Not Available</i>	MTGMP-31787-003	Relay, 2 Brake, 2 Speed, 8 inch	

OTIS



Hydro

Image	Part Number	Description	Alt/Sub/Sup P/N
	MTGMP-16783	I/O Interface Board	
<i>Photo Not Available</i>	MTGMP-24248	Load Cell Amplifier	
	MTGMP-16784	Mother Board, Base Board, I/O	MTGMP-15771
<i>Photo Not Available</i>	MTGMP-15603	Performance Comparator Board	
	MTGMP-15885	Prom II 64K Board	

© 2010, Otis Elevator Company (rev. November 2010)

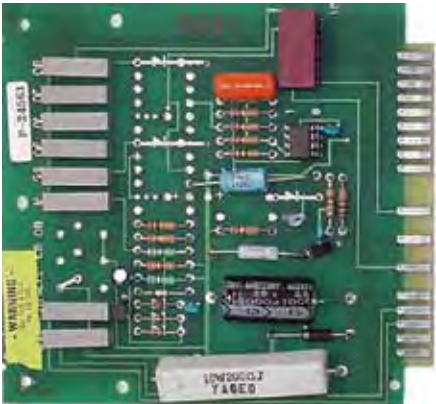

PC BOARDS

MAC Door Operator

Image	Part Number	Description	Alt/Sub/Sup P/N
<i>Photo Not Available</i>	*MAC0P-24783	104 Door Control Board	MAC0P-24783-004
	MAC0P-24783-004	104 Door Control Board	
<i>Photo Not Available</i>	*MTGMP-24783	Door Board	MAC0P-24783
	*MTGMP-24783-004	Door Board	MAC0P-24783-004
<i>Photo Not Available</i>	MTGMP-24173	Door Control Power, HP	
<i>Photo Not Available</i>	*MAC0P-24173	HP Power Board	MTGMP-24173
<i>Photo Not Available</i>	*MTGMP-24562	MAC High Performance Door Speed Board	MTGMP-24561
	MTGMP-24561	MAC Motor Speed Board	

OTIS

Montgomery MAC Door Operator (continued)

Image	Part Number	Description	Alt/Sub/Sup P/N
	MAC0P-24864	MAC,104, Can, Aux	
<i>Photo Not Available</i>	*MAC0P-15766	Mother Board	MAC0P-24783
<i>Photo Not Available</i>	*MAC0P-24172	Power Board	MTGMP-24172
	MTGMP-24172	Power Board	
<i>Photo Not Available</i>	*MAC0P-24561	Speed Board	MTGMP-24561
	MTGMP-24170	Speed Board	MTGMP-24561
<i>Photo Not Available</i>	*MAC0P-15764	Speed Control	MTGMP-15764
<i>Photo Not Available</i>	*MTGMP-16363	Speed Control	
<i>Photo Not Available</i>	*MAC0P-24170	Speed Control Board	MTGMP-24170

© 2010, Otis Elevator Company (rev. November 2010)

PC BOARDS

MIPROM 21

Image	Part Number	Description	Alt/Sub/Sup P/N
<i>Photo Not Available</i>	*MTGM91980-002	1336 AC Drive, 80 Amp	
<i>Photo Not Available</i>	*MTGM90153-006	1395 Digital DC Drive, 56 Amp	
<i>Photo Not Available</i>	*MTGM90154-002	1395 Digital DC Drive, 80 Amp, 460 VAC, Series A Drive	MTGM90720-003
<i>Photo Not Available</i>	MTGM90720-003	1395 Digital DC Drive, 110 Amp	



MTGMP-30323 Card Rack Assembly



MTGMP-16801 Card Rack Assembly. Uses P-16767 as a mother board.

<i>Photo Not Available</i>	MTGMP-24377	CPU Board	MTGMP-31807-002
<i>Photo Not Available</i>	MTGMP-31807-002	CPU Board	
<i>Photo Not Available</i>	MTGMP-24873	CPU Board 256K	MTGMP-31807-002
<i>Photo Not Available</i>	MTGMP-24872	CPU Board, 64K	MTGMP-24873
<i>Photo Not Available</i>	*MTGMP-26250-232	Dual Bridge Field Control, 480 V	

OTIS

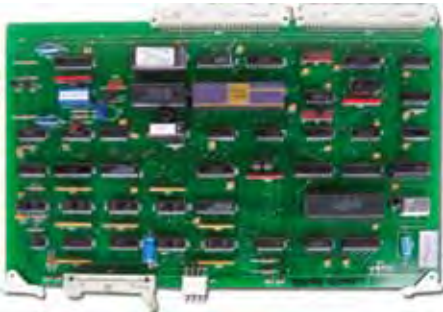
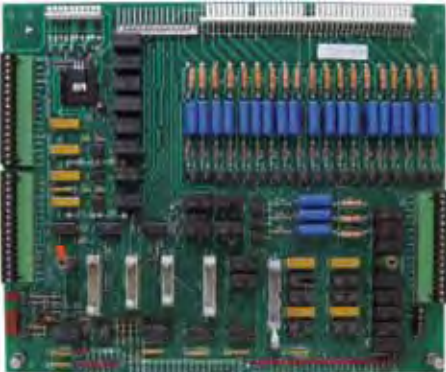

Montgomery MIPROM 21 (continued)

Image	Part Number	Description	Alt/Sub/Sup P/N
	MTGMP-24571	ETS Board	
<i>Photo Not Available</i>	MTGMP-31675	M2 Relay Pilot Board	
<i>Photo Not Available</i>	*MTGMP-24842	M2, CPU2, SIO2, EPROM	
	MTGMP-24301	M2, Parallel I/O, F Board	
	MTGMP-24323	M2, Relay Pilot Board	

© 2010, Otis Elevator Company (rev. November 2010)



PC BOARDS

©2010, Otis Elevator Company (rev. November 2010)

Image	Part Number	Description	Alt/Sub/Sup P/N
	MTGM95740-002	Main Control Board	
<i>Photo Not Available</i>	MTGMP-24568-001	Mega, NTS, 1 Switch	
<i>Photo Not Available</i>	MTGMP-24568-002	Mega, NTS, 2 Switch	
<i>Photo Not Available</i>	MTGMP-24568-003	Mega, NTS, 3 Switch	
<i>Photo Not Available</i>	MTGMP-24568-005	Mega, NTS, 5 Switch	
<i>Photo Not Available</i>	*MTGMP-24615	MIPROM	MTGMP-24377
	MTGMP-24150	MLS Door Operator Board	MTGMP-22267-002, WRLD7603.9008
<i>Photo Not Available</i>	MTGMP-22267-002	MLS Upgrade w/Motor Board Etc.	
<i>Photo Not Available</i>	MTGMP-24288	Mother Board	
<i>Photo Not Available</i>	MTGMP-16802	Mother Board, I/O Card Rack	MTGMP-15771
<i>Photo Not Available</i>	*MTGMP-24700-002	MST2 Relay Input	MTGMP-24700-004
<i>Photo Not Available</i>	MTGMP-24700-001	MST2, 110 AC, Relay	
<i>Photo Not Available</i>	*MTGMP-24700-003	MST2, 110 DC, Relay	MTGMP-24700-004
<i>Photo Not Available</i>	MTGMP-24700-004	MST2, 230 DC, Relay	
	MTGMP-24321	MSU Board	MTGMP-30387

OTIS



Montgomery MIPROM 21 (continued)

Image	Part Number	Description	Alt/Sub/Sup P/N
	MTGMP-24972	MSU Board	MTGMP-30387
<i>Photo Not Available</i>	MTGMP-30387	MSU Board	
	MTGMP-30390	MSU Board	MTGMP-30387
<i>Photo Not Available</i>	MTGMP-24302	P I/O Buffer Board	
<i>Photo Not Available</i>	MTGMP-24264	PC Monitor Board	
<i>Photo Not Available</i>	MTGMP-24869-003	PI, Dig, #3, w/EPROM, Service	
<i>Photo Not Available</i>	*MTGMA-46223	Power Board	
	MTGMP-24325	Power Relay Board	
<i>Photo Not Available</i>	*MTGMB-49711	Power Relay, Bare Board	MTGMP-24172
<i>Photo Not Available</i>	MTGMP-29077	Power Supply	
<i>Photo Not Available</i>	*MTGMP-29089	Power Supply	MTGMP-31895-002
<i>Photo Not Available</i>	MTGMP-24298	Prom Board	

© 2010, Otis Elevator Company (rev. November 2010)



PC BOARDS

©2010, Otis Elevator Company (rev. November 2010)

Image	Part Number	Description	Alt/Sub/Sup P/N
	MTGMP-31684-001	Relay Interface Board	
<i>Photo Not Available</i>	*MTGMP-16757	Relay Mother Board	
<i>Photo Not Available</i>	*MTGMP-16364	Relay Power Door Board	MTGMP-24172
<i>Photo Not Available</i>	MTGMP-24440	RS-232 Interface Board	
<i>Photo Not Available</i>	MTGMP-24441-001	RS-485 Interface Board	
	MTGMP-31652-002	SIO,2neur, RS485molx	
<i>Photo Not Available</i>	*MTGMB-47130	Univ AC Output, Bare Board	
<i>Photo Not Available</i>	*MTGMP-16776	Univ AC Output, w/Terminal Connector	MTGMP-15775
<i>Photo Not Available</i>	*MTGMB-47109	Univ Input II, Bare Board	MTGMP-29629-002

OTIS





MIPROM Hydro and Traction

Image	Part Number	Description	Alt/Sub/Sup P/N
<i>Photo Not Available</i>	*MTGMP-16777	AC Output, w/Molex Connector	MTGMP-15774
<i>Photo Not Available</i>	MTGM49860-036	Cable Relay Output Assy.	
<i>Photo Not Available</i>	MTGMP-15838	Card Rack	MTGMP-15839
	MTGMP-30323	Card Rack Assembly	
<i>Photo Not Available</i>	MTGMP-15778	DC Output, w/Terminal Connector	MTGM49860-036 MTGMP-24100
<i>Photo Not Available</i>	*MTGMP-15785	Input Board, w/Terminal Strip	
	MTGMP-15903	Power Supply	

© 2010, Otis Elevator Company (rev. November 2010)



PC BOARDS

MIPROM Hydro

Image	Part Number	Description	Alt/Sub/Sup P/N
	MTGMP-15771	Card Rack Assembly, MIPROM I/O w/LM317T	
	MTGMP-15839	CPU I/O Card Rack Assembly	
	MTGMP-15783	CPU MIPROM SC/MP II Board	
<i>Photo Not Available</i>	*MTGMP-16778	DC Output Board w/Terminal Block Connector	MTGMP-24100
	MTGMP-15764	Door Operator Speed Control Board	MAC0P-24783-004
	MTGMP-15828	Hydro PM Relay, Finl	

OTIS





Montgomery MIPROM Hydro (continued)

Image	Part Number	Description	Alt/Sub/Sup P/N
<i>Photo Not Available</i>	MTGMP-15730	Input Board, w/Terminal Block	MTGMP-29629-001
	MTGMP-15761	Input w/Terminal Block Connector	MTGMP-29629-001
<i>Photo Not Available</i>	*MTGMP-24785	M2 Memory Board	
	MTGMP-15766	MAC Speed Control Board	MAC0P-24783-004
	MTGMP-15774	Output 8X AC, w/Dual Triax, Molex Connector	
	MTGMP-15775	Output 8X, w/Terminal Connector	
	MTGMP-24147	Output Board	

© 2010, Otis Elevator Company (rev. November 2010)

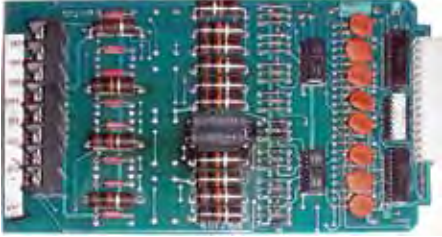



PC BOARDS

©2010, Otis Elevator Company (rev. November 2010)

Image	Part Number	Description	Alt/Sub/Sup P/N
	MTGMP-24151	Output Board w/Montgomery Block	
<i>Photo Not Available</i>	*MTGMP-16775	Output Board, 4 AC and 4 DC Outputs	MTGMP-24100
	MTGMP-16835	Power Board, MIPROM	
	*MTGMP-15765	Power Door	MTGMP-24172
	MTGMP-24100	Relay Output Board	
	MTGMP-16553	Timer	

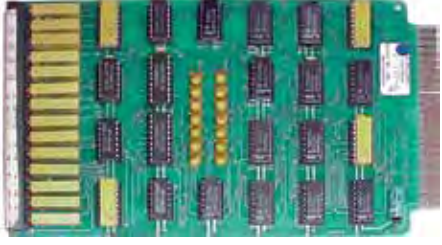
OTIS

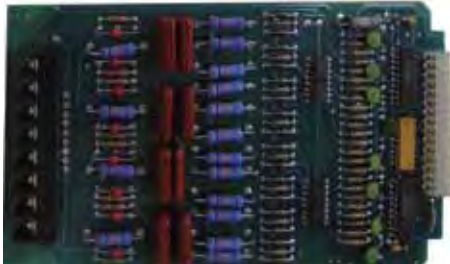
Montgomery MIPROM Hydro (continued)

Image	Part Number	Description	Alt/Sub/Sup P/N
<i>Photo Not Available</i>	MTGMP-16779	Timer Board 4X	
<i>Photo Not Available</i>	*MTGMP-16780	Timer Board 9X, Adjustable	MTGMP-15760
	MTGMP-15760	Timer Board X14	
<i>Photo Not Available</i>	MTGMP-15758	Timer Board X4	
<i>Photo Not Available</i>	MTGMP-15759	Timer Board X8	
	MTGMP-16785	Universal Input Board, w/Terminal Block Connectors	
	MTGMP-29630-001	Universal Input II w/Molex Board	
<i>Photo Not Available</i>	MTGMP-15731	Universal Input II w/Molex Connector	MTGMP-29630-001
<i>Photo Not Available</i>	MTGMP-16786	Universal Input II w/Molex Connector	
	MTGMP-15762	Universal Input II w/Molex Connectors	MTGMP-29630-001

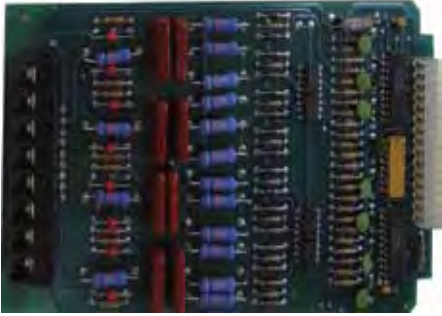

© 2010, Otis Elevator Company (rev. November 2010)

PC BOARDS

Image	Part Number	Description	Alt/Sub/Sup P/N
	MTGMP-29629-001	Universal Input II w/Terminal Block	MTGMP-29629-002
<i>Photo Not Available</i>	MTGMP-29629-002	Universal Input II w/Terminal Block	

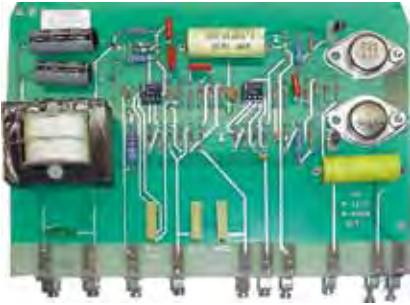

OTIS

SSC-6010

Image	Part Number	Description	Alt/Sub/Sup P/N
	MTGM46255-001	2CA SSC6010 Board	MTGMP-24115
	MTGMP-24115	2CA SSC-6010 Board	
<i>Photo Not Available</i>	*MTGM46256-001	3CA SSC6010 Board	
<i>Photo Not Available</i>	MTGMP-24117	3CA SSC-6010 Board, Universal	
<i>Photo Not Available</i>	*MTGM46257	4CA SSC6010 Board	
<i>Photo Not Available</i>	MTGMP-24109	6 Pulse Firing Board	
<i>Photo Not Available</i>	MTGMP-24119	6CA SSC-6010 Board	
	MTGMP-24120	7CA SSC-6010 Board - Montgomery MIRPOM 21	
<i>Photo Not Available</i>	MTGMP-24110	Distribution Board	
<i>Photo Not Available</i>	MTGMP-24107	Dual Bridge Field Control, 240 V	
	MTGMP-24112	LIN 6010 Accl/Decl	

© 2010, Otis Elevator Company (rev. November 2010)

PC BOARDS

Image	Part Number	Description	Alt/Sub/Sup P/N
<i>Photo Not Available</i>	MTGM46246-001	Motor Field Power	
<i>Photo Not Available</i>	*MTGM-46246	Motor I Control Board	MTGM46246-001
	MTGMP-24105	SS Field Regulation Board	
	MTGMP-24103	SS Multiple Operator	
<i>Photo Not Available</i>	MTGMP-24114	SS Precise Reference Board	

OTIS

TMS 900

Image	Part Number	Description	Alt/Sub/Sup P/N
<i>Photo Not Available</i>	MTGM515877	Board US515877	
<i>Photo Not Available</i>	MTGM515995	Board 515995	
<i>Photo Not Available</i>	MTGM516304	Board 516304	
<i>Photo Not Available</i>	MTGM516463	CPU-88 Computer Board	KONE357290G02
<i>Photo Not Available</i>	KONE357290G02	CPU-88 Computer Board	MTGM516463
<i>Photo Not Available</i>	MTGM515629	Current Reg Straight CO Board	
<i>Photo Not Available</i>	MTGMP-24548-003	ESC Speed Board	
<i>Photo Not Available</i>	MTGM518240	Firing SCD Board	
<i>Photo Not Available</i>	MTGM515611	I/O Module Board	
<i>Photo Not Available</i>	MTGM515569	Power Supply Board	
<i>Photo Not Available</i>	MTGM515635	Pulse Counter Board	
<i>Photo Not Available</i>	MTGM515779	Speed Board	
<i>Photo Not Available</i>	MTGM515568	Speed Reference Board A6A6 4TMS900	
<i>Photo Not Available</i>	MTGM515699	Speed Regulator Board	
<i>Photo Not Available</i>	MTGM515830	Supervision SCD Rack	
<i>Photo Not Available</i>	MTGM515570	Transformer Pulse Board	

© 2010, Otis Elevator Company (rev. November 2010)

Otis

506 Escalators

Image	Part Number	Description	Alt/Sub/Sup P/N	Application
<i>Photo Not Available</i>	*A9707C1	Motherboard	A9707C3	506SL
<i>Photo Not Available</i>	A9707C3	Motherboard		506SL
<i>Photo Not Available</i>	*A9707C4	Motherboard		506SL
<i>Photo Not Available</i>	YXG0630D1	Relay Assembly	YXG0630D2	506
<i>Photo Not Available</i>	YXG0630D2	Relay Assembly		506
<i>Photo Not Available</i>	YXG0630D3	Relay Assembly, 110/220 V		506

Balance Bridge Detector



Image	Part Number	Description
<i>Photo Not Available</i>	7088AT1	Board
<i>Photo Not Available</i>	*7048AD1	Power Supply
<i>Photo Not Available</i>	*7048G2	Power Supply
<i>Photo Not Available</i>	*7048AW1	Preamplifier
<i>Photo Not Available</i>	*7088AB	Repair And Return Board
<i>Photo Not Available</i>	*7088B1	Repair And Return Board
<i>Photo Not Available</i>	*7088B2	Repair And Return Board
<i>Photo Not Available</i>	*7088G	Repair And Return Board
<i>Photo Not Available</i>	*7088H	Repair And Return Board
<i>Photo Not Available</i>	*7088J	Repair And Return Board
<i>Photo Not Available</i>	*7088P	Repair And Return Board
<i>Photo Not Available</i>	*7088R	Repair And Return Board
<i>Photo Not Available</i>	*7088T	Repair And Return Board
<i>Photo Not Available</i>	*7088W	Repair And Return Board

Black Belt Door Operator

Image	Part Number	Description
	AAA26800AHJ1	Board Assembly

OTIS

CB Base

Image	Part Number	Description	Alt/Sub/Sup P/N
<i>Photo Not Available</i>	*6-A8124SS1	B Base OCB	
	8120P1	Binary Decoder Interface Board	
<i>Photo Not Available</i>	8120F1	Binary Position Encoder (BPE) Board	
	8120F2	Binary Position Encoder (BPE) Board	
<i>Photo Not Available</i>	8120B2	Binary Reading Board (for 8126H1)	
<i>Photo Not Available</i>	8120C2	Binary Reading Board (for 8126H2)	
<i>Photo Not Available</i>	8120C1	Binary Reading Board (for 8126H3)	
	8120B1	Binary Reading Board (for 8126H4)	
<i>Photo Not Available</i>	*114-A8124AL3	Board	A8114AA3
<i>Photo Not Available</i>	*11-A8125AL1	Board	

© 2010, Otis Elevator Company (rev. November 2010)

PC BOARDS

Image	Part Number	Description	Alt/Sub/Sup P/N
<i>Photo Not Available</i>	*131-A8124AL1	Board	
<i>Photo Not Available</i>	*133-A8124AL1	Board	
<i>Photo Not Available</i>	*134-A8124AL1	Board	A8112H3
<i>Photo Not Available</i>	*141-A8124AL1	Board	
<i>Photo Not Available</i>	*142-A8124AL1	Board	
<i>Photo Not Available</i>	*18-A8124AL10	Board	
<i>Photo Not Available</i>	*19-A8124PB1	Board	A8124UN419
<i>Photo Not Available</i>	*1-A8119AK2	Board	
<i>Photo Not Available</i>	*1-A8123A7	Board	
<i>Photo Not Available</i>	*1-A8124AL1	Board	
<i>Photo Not Available</i>	*21-A8124AL1	Board	
<i>Photo Not Available</i>	*22-A8124AL1	Board	
<i>Photo Not Available</i>	*22-A8124AL2	Board	
<i>Photo Not Available</i>	*23-A8124AL1	Board	
<i>Photo Not Available</i>	*23-A8124SS1	Board	
<i>Photo Not Available</i>	*24-A8124AL1	Board	
<i>Photo Not Available</i>	*25-A8124AL1	Board	
<i>Photo Not Available</i>	*26-A8124AL2	Board	
<i>Photo Not Available</i>	*27-A8124AL1	Board	
<i>Photo Not Available</i>	*29-A8124AL1	Board	
<i>Photo Not Available</i>	*2-A8124A5	Board	
<i>Photo Not Available</i>	*2-A8124AL1	Board	
<i>Photo Not Available</i>	*2-A8124AL2	Board	
<i>Photo Not Available</i>	*30-A8124AL1	Board	
<i>Photo Not Available</i>	*46-A8124AL2	Board	
<i>Photo Not Available</i>	*48-A8124AL1	Board	
<i>Photo Not Available</i>	*51-A8124AL1	Board	
<i>Photo Not Available</i>	*51-A8124PB3	Board	
<i>Photo Not Available</i>	*52-A8124AL3	Board	
<i>Photo Not Available</i>	*53-A8124AL1	Board	
<i>Photo Not Available</i>	*54-A8124PB1	Board	A8124UN454
<i>Photo Not Available</i>	*56-A8124AL2	Board	
<i>Photo Not Available</i>	*57-A8124PB1	Board	
<i>Photo Not Available</i>	*64-A8124AL1	Board	
<i>Photo Not Available</i>	*64-A8124AL2	Board	
<i>Photo Not Available</i>	*80-A8124AL1	Board	
<i>Photo Not Available</i>	*8110A5	Board	
<i>Photo Not Available</i>	*8114A1	Board	

OTIS

Otis CB Base (continued)

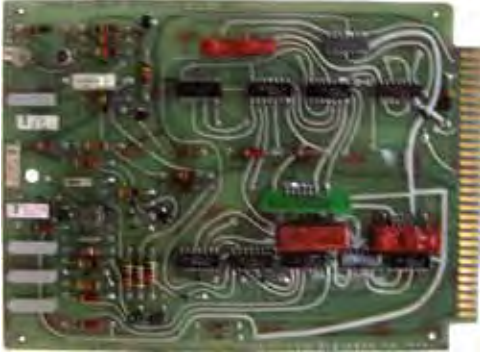
Image	Part Number	Description	Alt/Sub/Sup P/N
<i>Photo Not Available</i>	*8120R1	Board	
<i>Photo Not Available</i>	*90-A8124AL1	Board	
<i>Photo Not Available</i>	*97-A8124AL1	Board	
<i>Photo Not Available</i>	*98-A8124AL1	Board	
<i>Photo Not Available</i>	*A8111A2	Board	
<i>Photo Not Available</i>	*A8111C2	Board	B8111C2
	*A8112B1	Board	
<i>Photo Not Available</i>	*A8112B2	Board	
<i>Photo Not Available</i>	*A8112B4	Board	
<i>Photo Not Available</i>	*A8112C11	Board	
<i>Photo Not Available</i>	*A8112F2	Board	
<i>Photo Not Available</i>	*A8113A3	Board	
<i>Photo Not Available</i>	*A8113B3	Board	
<i>Photo Not Available</i>	*A8113B6	Board	
<i>Photo Not Available</i>	*A8113G1	Board	
<i>Photo Not Available</i>	*A8113H2	Board	
<i>Photo Not Available</i>	*A8113J3	Board	B8113J3
<i>Photo Not Available</i>	*A8113K1	Board	
<i>Photo Not Available</i>	*A8113K3	Board	C8113K5
<i>Photo Not Available</i>	*A8113N2	Board	
<i>Photo Not Available</i>	*A8113P3	Board	
<i>Photo Not Available</i>	*A8113P6	Board	
<i>Photo Not Available</i>	*A8113P7	Board	
<i>Photo Not Available</i>	*A8115B2	Board	
<i>Photo Not Available</i>	*A8116A10	Board	
<i>Photo Not Available</i>	*A8116A6	Board	
<i>Photo Not Available</i>	*A8116A7	Board	
<i>Photo Not Available</i>	*A8124UN54	Board	
<i>Photo Not Available</i>	*B8113K1	Board	

PC BOARDS

©2010, Otis Elevator Company (rev. November 2010)

Image	Part Number	Description	Alt/Sub/Sup P/N
<i>Photo Not Available</i>	100-A8112J1	Board	
<i>Photo Not Available</i>	100-B8112A1	Board	
<i>Photo Not Available</i>	135-A8124AL2	Board	
<i>Photo Not Available</i>	139-A8124AL1	Board	
<i>Photo Not Available</i>	1-7088B1	Board	
<i>Photo Not Available</i>	1-A8119AK1	Board	
<i>Photo Not Available</i>	24-A8124SS1	Board	
<i>Photo Not Available</i>	28-A8124SS1	Board	
<i>Photo Not Available</i>	29-A8124SS1	Board	
<i>Photo Not Available</i>	70-A8124AL2	Board	

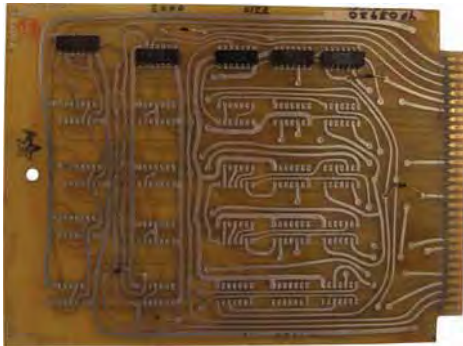

A8110A1 Board

<i>Photo Not Available</i>	A8110A2	Board	
<i>Photo Not Available</i>	A8110A3	Board	
<i>Photo Not Available</i>	A8110A4	Board	
<i>Photo Not Available</i>	A8110A5	Board	
<i>Photo Not Available</i>	A8110B1	Board	
<i>Photo Not Available</i>	A8110G1	Board	
<i>Photo Not Available</i>	A8111A1	Board	
<i>Photo Not Available</i>	A8111A3	Board	
<i>Photo Not Available</i>	A8111C3	Board	
<i>Photo Not Available</i>	A8112B3	Board	
<i>Photo Not Available</i>	A8112C1	Board	
<i>Photo Not Available</i>	A8112C10	Board	



A8112C12 Board

OTIS

Otis CB Base (continued)

Image	Part Number	Description	Alt/Sub/Sup P/N
<i>Photo Not Available</i>	A8112C13	Board	
<i>Photo Not Available</i>	A8112C2	Board	
<i>Photo Not Available</i>	A8112C3	Board	
<i>Photo Not Available</i>	A8112D2	Board	
<i>Photo Not Available</i>	A8112E1	Board	
<i>Photo Not Available</i>	A8112F1	Board	
<i>Photo Not Available</i>	A8112F3	Board	
<i>Photo Not Available</i>	A8112H3	Board	
<i>Photo Not Available</i>	A8113B2	Board	
<i>Photo Not Available</i>	A8113B4	Board	
<i>Photo Not Available</i>	A8113B5	Board	
<i>Photo Not Available</i>	A8113B7	Board	
<i>Photo Not Available</i>	A8113C1	Board	
<i>Photo Not Available</i>	A8113C2	Board	
<i>Photo Not Available</i>	A8113C3	Board	
<i>Photo Not Available</i>	A8113D1	Board	
<i>Photo Not Available</i>	A8113D2	Board	
<i>Photo Not Available</i>	A8113E1	Board	
<i>Photo Not Available</i>	A8113F1	Board	
<i>Photo Not Available</i>	A8113G2	Board	
<i>Photo Not Available</i>	A8113H3	Board	
<i>Photo Not Available</i>	A8113N10	Board	
<i>Photo Not Available</i>	A8113N11	Board	
<i>Photo Not Available</i>	A8113N5	Board	
<i>Photo Not Available</i>	A8113P2	Board	
<i>Photo Not Available</i>	A8113R1	Board	
<i>Photo Not Available</i>	A8115A1	Board	
<i>Photo Not Available</i>	A8115B1	Board	
<i>Photo Not Available</i>	B8110C1	Board	







B8110C2 Board

© 2010, Otis Elevator Company (rev. November 2010)



PC BOARDS

©2010, Otis Elevator Company (rev. November 2010)

Image	Part Number	Description	Alt/Sub/Sup P/N
	B8110G1	Board	
	B8112A3	Board	
<p data-bbox="337 1052 548 1079"><i>Photo Not Available</i></p>	B8112B1	Board	
	B8112B3	Board	
<p data-bbox="337 1459 548 1486"><i>Photo Not Available</i></p>	B8112C1	Board	
	B8112H2	Board	

OTIS

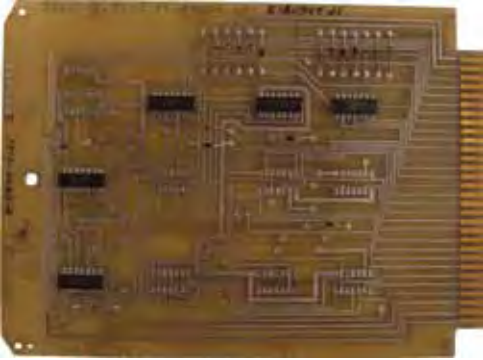
Otis CB Base (continued)

Image	Part Number	Description	Alt/Sub/Sup P/N
	B8113J2	Board	
	B8113J4	Board	
<i>Photo Not Available</i>	B8113J5	Board	
	B8113K3	Board	
<i>Photo Not Available</i>	B8113K5	Board	
<i>Photo Not Available</i>	B8114G1	Board	
<i>Photo Not Available</i>	B8115B1	Board	

© 2010, Otis Elevator Company (rev. November 2010)

PC BOARDS

©2010, Otis Elevator Company (rev. November 2010)

Image	Part Number	Description	Alt/Sub/Sup P/N
	B8115B2	Board	
<i>Photo Not Available</i>	B8115B3	Board	
	C8113K5	Board	
<i>Photo Not Available</i>	*11-8125AL1	Board, Repair & Return	
<i>Photo Not Available</i>	*15-A8124AL1	Board, Repair & Return	
<i>Photo Not Available</i>	*16-8124AL3	Board, Repair & Return	
<i>Photo Not Available</i>	*16-A8124AL1	Board, Repair & Return	
<i>Photo Not Available</i>	*19-8124AL2	Board, Repair & Return	
<i>Photo Not Available</i>	*1-A8119P1	Board, Repair & Return	
<i>Photo Not Available</i>	*1-A8124AL3	Board, Repair & Return	
<i>Photo Not Available</i>	*1-A8124PB1	Board, Repair & Return	A8124UN401
<i>Photo Not Available</i>	*25-A8124SS1	Board, Repair & Return	
<i>Photo Not Available</i>	*26-A8124AL1	Board, Repair & Return	
<i>Photo Not Available</i>	*26-A8124SS1	Board, Repair & Return	
<i>Photo Not Available</i>	*2-A8124A4	Board, Repair & Return	
<i>Photo Not Available</i>	*2-A8125PB5	Board, Repair & Return	
<i>Photo Not Available</i>	*31-A8124PB1	Board, Repair & Return	A8124UN431
<i>Photo Not Available</i>	*3-A8124AL2	Board, Repair & Return	
<i>Photo Not Available</i>	*46-A8124AL1	Board, Repair & Return	
<i>Photo Not Available</i>	*70-A8124AL1	Board, Repair & Return	
<i>Photo Not Available</i>	*73-8124AL1	Board, Repair & Return	
<i>Photo Not Available</i>	*87-A8124AL1	Board, Repair & Return	
<i>Photo Not Available</i>	*87-A8124AL2	Board, Repair & Return	

OTIS

Otis CB Base (continued)

Image	Part Number	Description	Alt/Sub/Sup P/N
<i>Photo Not Available</i>	*88-A8124AL1	Board, Repair & Return	
<i>Photo Not Available</i>	*A8110C2	Board, Repair & Return	
<i>Photo Not Available</i>	*A8112B7	Board, Repair & Return	
<i>Photo Not Available</i>	*A8113K2	Board, Repair & Return	
<i>Photo Not Available</i>	*A8113N8	Board, Repair & Return	
<i>Photo Not Available</i>	*B8112A1	Board, Repair & Return	
<i>Photo Not Available</i>	*125-A8124AL1	Board, Repair Only	
<i>Photo Not Available</i>	*13-A8124AL1	Board, Repair Only	
<i>Photo Not Available</i>	*43-A8124AL1	Board, Repair Only	
<i>Photo Not Available</i>	*9-A8124AL1	Board, Repair Only	
<i>Photo Not Available</i>	*55-A8124AL1	Car Shuttle Service No. 2	
<i>Photo Not Available</i>	*100-8112B3	Car Variable 3 (CV3) Board	

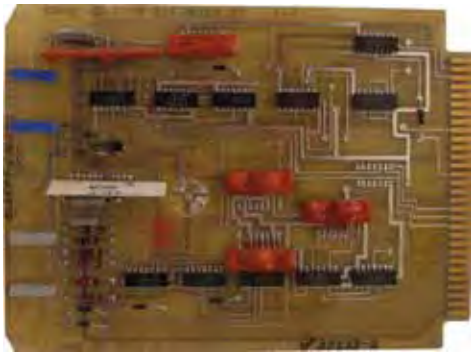

C8112B1 Car Variable 3 (CV3) Board

<i>Photo Not Available</i>	C8112B10	Car Variable 3 (CV3) Board	
<i>Photo Not Available</i>	C8112B11	Car Variable 3 (CV3) Board	
<i>Photo Not Available</i>	C8112B2	Car Variable 3 (CV3) Board	
<i>Photo Not Available</i>	C8112B3	Car Variable 3 (CV3) Board	
<i>Photo Not Available</i>	C8112B4	Car Variable 3 (CV3) Board	
<i>Photo Not Available</i>	C8112B7	Car Variable 3 (CV3) Board	
<i>Photo Not Available</i>	C8112B8	Car Variable 3 (CV3) Board	
<i>Photo Not Available</i>	*1-A8124H1	Car Variable No. 2 (CV2H)	
<i>Photo Not Available</i>	*A8112C8	CC2 Board, Car Variable No.2	
<i>Photo Not Available</i>	*2-A8124PB1	Chicago Special Emergency Service Board	A8124UN402
<i>Photo Not Available</i>	*A8113J1	CV4 Board	B8113J1
<i>Photo Not Available</i>	*B8113J3	CV4 Board	
<i>Photo Not Available</i>	B8113J1	CV4 Board	

PC BOARDS

©2010, Otis Elevator Company (rev. November 2010)

Image	Part Number	Description	Alt/Sub/Sup P/N
	A8112A3	Delayed Car and Door Protection Board	
<i>Photo Not Available</i>	100-B8112C1	Delayed Car and Door Protection-R Board	
<i>Photo Not Available</i>	*5-A8124AL1	Direction One Floor Run & Residual Card	
<i>Photo Not Available</i>	1-A8124B1	Door Operation, Door Time, Upper Deck Board	
<i>Photo Not Available</i>	A8116A1	Electronic Hall Call Register Board	
<i>Photo Not Available</i>	A8116A11	Electronic Hall Call Register Board	
<i>Photo Not Available</i>	A8116A12	Electronic Hall Call Register Board	
<i>Photo Not Available</i>	A8116A3	Electronic Hall Call Register Board	
<i>Photo Not Available</i>	A8116A4	Electronic Hall Call Register Board	
<i>Photo Not Available</i>	A8116A9	Electronic Hall Call Register Board	
<i>Photo Not Available</i>	1-A8124A5	Floor Functions Lower Deck (FIF-F5F) Board	
<i>Photo Not Available</i>	*3-A8125AL2	Group Emergency Power Car	
<i>Photo Not Available</i>	10-A8125AL1	Group Emergency Power for EDP or E3P (G01)	
<i>Photo Not Available</i>	B8111C2	Group Zone Board	
<i>Photo Not Available</i>	*1-A8124Y1	Interface, Lower Deck Board, 120 VDC	
<i>Photo Not Available</i>	C8114G1	Lantern Driver Board	
<i>Photo Not Available</i>	100-A8116B1	Mech Hall Call Reg Board	
<i>Photo Not Available</i>	*9-A8124AL3	MOS Board	
<i>Photo Not Available</i>	*14-CAA26800N1	Motion Control Board	
<i>Photo Not Available</i>	*17-CAA26800N1	Motion Control Board	
<i>Photo Not Available</i>	*19-CAA26800N1	Motion Control Board	
<i>Photo Not Available</i>	16-CAA26800N1	Motion Control Board	

OTIS

Otis CB Base (continued)

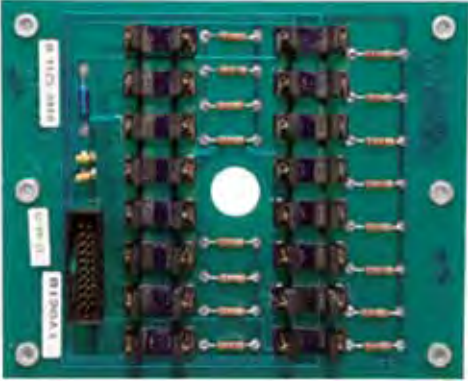
Image	Part Number	Description	Alt/Sub/Sup P/N
<i>Photo Not Available</i>	*14-8124AL1	Motion-GWT Board	14-CAA26800N1
<i>Photo Not Available</i>	*16-8124AL1	Motion-GWT Board	16-CAA26800N1
<i>Photo Not Available</i>	*17-8124AL1	Motion-GWT Board	17-CAA26800N1
<i>Photo Not Available</i>	*19-8124AL1	Motion-GWT Board	19-CAA26800N1
	8120A1	Optical Sensor Board	
<i>Photo Not Available</i>	A8113H1	PC Panel	
<i>Photo Not Available</i>	*A7048AD1	Power Supply	
<i>Photo Not Available</i>	*A8126A1	Power Supply	
<i>Photo Not Available</i>	*B7048AD1	Power Supply Assembly	
<i>Photo Not Available</i>	1-A8125AL1	Power Supply Board, 15 Volt	
<i>Photo Not Available</i>	*34-A8124AL2	Pre-Amplifier Card	
<i>Photo Not Available</i>	13-A8125AL3	R-Board	
<i>Photo Not Available</i>	1-A8124C1	Rear Direction And Hall Lantern Board	
<i>Photo Not Available</i>	AAA26800RE1	Regulator Power Supply Card	
<i>Photo Not Available</i>	*100-A8114F1	Security Cutout Board	
<i>Photo Not Available</i>	8120G1	Slowdown Control Printed Board	
<i>Photo Not Available</i>	*103-A8124AL1	Special Emergency Service Board	
<i>Photo Not Available</i>	*113-A8124AL1	Special Emergency Service Board	
<i>Photo Not Available</i>	108-A8124AL1	Special Emergency Service Board	
<i>Photo Not Available</i>	110-A8124AL1	Special Emergency Service Board	
<i>Photo Not Available</i>	*114-A8124AL1	Supplemental Interface Board	A8114AA1
<i>Photo Not Available</i>	*114-A8124AL10	Supplemental Interface Function Board	A8114AA10

© 2010, Otis Elevator Company (rev. November 2010)

PC BOARDS

Image	Part Number	Description	Alt/Sub/Sup P/N
	B8117B1	Test Signal Board	
<i>Photo Not Available</i>	* A8124UN401	Universal Board	
<i>Photo Not Available</i>	*A8124UN	Universal Board	
<i>Photo Not Available</i>	A8124UN402	Universal Board	
<i>Photo Not Available</i>	A8124UN419	Universal Board	
<i>Photo Not Available</i>	A8124UN432	Universal Board	
<i>Photo Not Available</i>	A8124UN454	Universal Board	
<i>Photo Not Available</i>	B8111A1	Zoning Board	
<i>Photo Not Available</i>	B8111A2	Zoning Board	
<i>Photo Not Available</i>	B8111A3	Zoning Board	
<i>Photo Not Available</i>	B8111C1	Zoning Board	
<i>Photo Not Available</i>	B8111C3	Zoning Board	

©2010, Otis Elevator Company (rev. November 2010)

OTIS

Elevonic 211

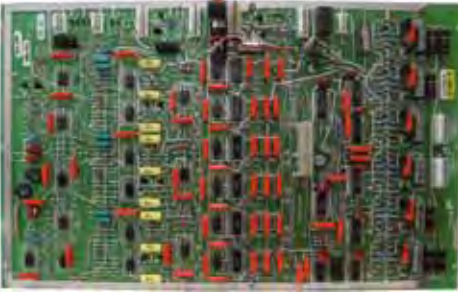

Image	Part Number	Description	Alt/Sub/Sup P/N	Application
<i>Photo Not Available</i>	ABA26800TS1	I/O Board		211M
<i>Photo Not Available</i>	ACA26800PR1	I/O Board, E211		211M
<i>Photo Not Available</i>	AAA26800TD1	Processor Board		211M
<i>Photo Not Available</i>	ABA26800PP1	Processor Board	AAA26800MT1	E211
<i>Photo Not Available</i>	GDA25005B10	RS 14 Board		211 (LR95)/ E411MC/Hydrau- lic Controller, Microprocessor Phase II (Unified Mod or NEB) 211LVM
<i>Photo Not Available</i>	AAB22439E5	Tape Reader Assembly		211M

© 2010, Otis Elevator Company (rev. November 2010)

PC BOARDS

Elevonic 101 & 401

©2010, Otis Elevator Company (rev. November 2010)

Image	Part Number	Description	Alt/Sub/Sup P/N
	LA46S2439-0010	12SCR Cont Board	
<i>Photo Not Available</i>	*LA46S1607-1080	12SCR Main/Aux Board	
<i>Photo Not Available</i>	LA46S1607-1050	12SCR Main/Aux Board	
	LA46S1607-1060	12SCR Main/Aux Board	
<i>Photo Not Available</i>	8403A1	Adfix Cab Fixture Interface Board	
	ABA26800ZZ1	ADPCM Speech Board, E401, E411, MRS	
<i>Photo Not Available</i>	*LA46S2285-0010	Base Assembly, Basic	
<i>Photo Not Available</i>	LA46S2442-0200	Board	
<i>Photo Not Available</i>	*HT201726-1	Interconnect Cab Board	
<i>Photo Not Available</i>	HT201727-1	Cab Controller Motherboard	
<i>Photo Not Available</i>	HT201728-1	Group Controller Motherboard	
<i>Photo Not Available</i>	HT201731-3	Cab I/O Board	HT201731-4
<i>Photo Not Available</i>	HT201732-1	Group Controller Communication I/O Board	

OTIS

Otis 101 & 401 (continued)

Image	Part Number	Description	Alt/Sub/Sup P/N
	HT201734-3	Relay I/O Board	
	*8200EB1	Board, E401, MRS, MRVF, E411	A8200EB1
<p><i>Photo Not Available</i></p>	*LA46S2438-0070	Bridge Assembly, E401	
<p><i>Photo Not Available</i></p>	HT201735-1	Buffer Board Assembly	
	HT201736-1	Bus Terminator Board	
<p><i>Photo Not Available</i></p>	HT204327-1	Bus Terminator Board	

© 2010, Otis Elevator Company (rev. November 2010)

PC BOARDS

©2010, Otis Elevator Company (rev. November 2010)

Image	Part Number	Description	Alt/Sub/Sup P/N
	HT201731-4	Cab I/O Board Assembly	
	HT203103-1	CF I/O Board	
	HT201732-4	Comm I/O Board	HT201732-1
	HT201732-8	Comm I/O Board	

OTIS



Otis 101 & 401 (continued)

Image	Part Number	Description	Alt/Sub/Sup P/N
	HT201732-6	Comm. I/O Board Assembly	
	8200EA1	Communication, HTS Buffer Board, E401, MRS	8200EA2
<p><i>Photo Not Available</i></p>	*8200EA2	Communication-HTS Buffer Board, E401	A8200EB4
	RB560-275-2	Control Board	
	RB560-275-05	Control Board /9	

© 2010, Otis Elevator Company (rev. November 2010)

PC BOARDS

©2010, Otis Elevator Company (rev. November 2010)

Image	Part Number	Description	Alt/Sub/Sup P/N
	A8200CA4	COP Board, Bush/Herr., E401	ABA25000D1
	ABA25000C1	COP II CPU/Pocket/Handle Sub-Assembly, E401	
<i>Photo Not Available</i>	HT204349-3	CPU Board Assembly, E401	HT206481-3 HT204349-4
<i>Photo Not Available</i>	HT204349-4	CPU Board Assembly, E401	HT204349-5
	HT204349-5	CPU Board Assembly, E401	
<i>Photo Not Available</i>	HT201788-3	CPU Board, E401	HT206481-4
<i>Photo Not Available</i>	SA14-193-770-572	DC Contactor, 250 V Coil, w/3TY7 Aux. Contact, LA, 401	

OTIS



Otis 101 & 401 (continued)

Image	Part Number	Description	Alt/Sub/Sup P/N
	SA14-193-770-570	DC Rev Contactor w/3TY7 Aux. Contact, E401	
<i>Photo Not Available</i>	SA14-193-770-571	DC Rev. Contactor, 250 V, w/3TY7 Aux. Contact, Robicon, 401	
	LA46S2206-0013	Elev Control Board	
	LA46S2440-0010	Elev Control Board	
<i>Photo Not Available</i>	RB362-302-01	Emergency Field Excitation	
<i>Photo Not Available</i>	HT205925-2	Power Amp I/O Eng. Build Board	

© 2010, Otis Elevator Company (rev. November 2010)

PC BOARDS

©2010, Otis Elevator Company (rev. November 2010)

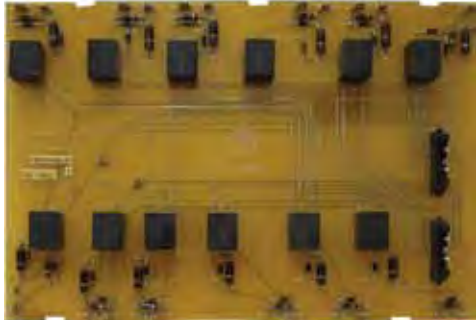
Image	Part Number	Description	Alt/Sub/Sup P/N
	RB560-276-02	Gate Board	
	RB560-276-05	Gate Board	
	LA46S1677-0070	Gate Firing Board	
	LA46S2441-0010	Gate Firing Board	

OTIS

Otis 101 & 401 (continued)

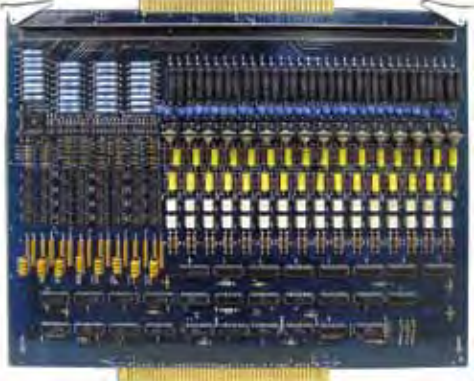
Image	Part Number	Description	Alt/Sub/Sup P/N
	HT203102-1	GF I/O Board	
<i>Photo Not Available</i>	*HT201723-1	GP I/O Full Board	HT201723-2
	HT201723-2	GP I/O Full Board	
<i>Photo Not Available</i>	LA46S2438-0050	Heat Sink	
<i>Photo Not Available</i>	LA46S2438-0010	Heat Sink Assembly	
<i>Photo Not Available</i>	LA46S2438-0020	Heat Sink Assembly	
<i>Photo Not Available</i>	LA46S2438-0030	Heat Sink Assembly	
<i>Photo Not Available</i>	LA46S2438-0040	Heat Sink Assembly	
<i>Photo Not Available</i>	LA46S2438-0060	Heat Sink Assembly	
<i>Photo Not Available</i>	RB326-052-4	Heat Sink Assembly	
<i>Photo Not Available</i>	RB326-052-5	Heat Sink Assembly	
<i>Photo Not Available</i>	RB326-052-1	Heat Sink Assembly R	
<i>Photo Not Available</i>	RB326-052-2	Heat Sink Assembly R	
<i>Photo Not Available</i>	RB326-052-3	Heat Sink Assembly R	
<i>Photo Not Available</i>	LA46S2284-0010	Heat Sink Assembly, E101	
<i>Photo Not Available</i>	HT201728-2	HTS Board	
<i>Photo Not Available</i>	HT203193-65	HYP. B-Module	
<i>Photo Not Available</i>	*AAA21000C2	KEC Group Power Supply on Adapter Plate Assembly, E401	AAA21000C3

© 2010, Otis Elevator Company (rev. November 2010)

PC BOARDS

©2010, Otis Elevator Company (rev. November 2010)

Image	Part Number	Description	Alt/Sub/Sup P/N
<i>Photo Not Available</i>	AAA21000C3	KEC Group Power Supply on Adapter Plate Assembly, E401	
<i>Photo Not Available</i>	8200BJ1	Keyboard, INTF-96S, E401	
<i>Photo Not Available</i>	*LA46S1606-0030	Low Voltage Power Supply	AAA8126K1
<i>Photo Not Available</i>	*A8200BT2	Pet Board	B8200BT2
<i>Photo Not Available</i>	B8200BT1	Pet Board	
<i>Photo Not Available</i>	B8200BT2	Pet Board	



B8200BT3	Pet Board	B8200BT2
----------	-----------	----------

<i>Photo Not Available</i>	HT204411-2	Power Amp	
<i>Photo Not Available</i>	HT206412-1	Power Amp	
<i>Photo Not Available</i>	HT201739-1	Power Amp Board	
<i>Photo Not Available</i>	HT205925-1	Power Amp I/O	
<i>Photo Not Available</i>	*HT201725-1	Power Amp I/O Board	HT205925-1
<i>Photo Not Available</i>	*HT201725-2	Power Amp I/O Board	HT205925-1
<i>Photo Not Available</i>	*HT201725-3	Power Amp I/O Board	HT205925-1
<i>Photo Not Available</i>	HT206020-2	Power Amp LA/RB	
<i>Photo Not Available</i>	*HT201781-2	Power Supply	205410-4
<i>Photo Not Available</i>	HT203193-3	Power Supply	205410-4





*AAA8126K1	Power Supply Assembly, E101	ABA8126K1
------------	-----------------------------	-----------

<i>Photo Not Available</i>	ABA8126K1	Power Supply Assembly, E101	
<i>Photo Not Available</i>	*205410-3	Power Supply Assembly, E401	205410-4
<i>Photo Not Available</i>	205410-4	Power Supply Assembly, E401	
<i>Photo Not Available</i>	HT201781-1	Power Supply (HTS)	

OTIS



Otis 101 & 401 (continued)

Image	Part Number	Description	Alt/Sub/Sup P/N
<i>Photo Not Available</i>	HT201450-1	Door Motor Power Amplifier	
<i>Photo Not Available</i>	*HT200710-2	PPT, E401	2700CBL1
<i>Photo Not Available</i>	2700CBL1	PPT, & Cable Assy.	
<i>Photo Not Available</i>	HT201788-1	Processor Board	HT201788-3
<i>Photo Not Available</i>	*HT206481-1	Processor Board Assembly	HT206481-3
<i>Photo Not Available</i>	HT206481-3	Processor Board Assembly	HT206481-4
<i>Photo Not Available</i>	HT206481-4	Processor Board Assembly	HT204349-5
<i>Photo Not Available</i>	*8200CA4	R/F Board, E401	A8200CA4
<i>Photo Not Available</i>	*HT202088-2	Relay I/O Board	HT203101-2
<i>Photo Not Available</i>	*HT203101-1	Relay I/O Board	HT203101-2
	HT203101-2	Relay I/O Board	
<i>Photo Not Available</i>	*HT201734-6	Relay I/O Board Assembly	HT203101-2
<i>Photo Not Available</i>	*LA46S2284-0030	SCR Bridge Assembly	LA46S2284-0040
<i>Photo Not Available</i>	*LA46S2284-0040	SCR Bridge Assembly	LA46S2284-0030
<i>Photo Not Available</i>	*LA46S2284-0050	SCR Bridge Assembly	LA46S2284-0060
<i>Photo Not Available</i>	LA46S2284-0020	SCR Bridge Assembly	
<i>Photo Not Available</i>	LA46S2284-0060	SCR Bridge Assembly	LA46S2284-0050
	A8200EB4	Speech Board, ADPCM, E401, MRS	ABA26800ZZ4
<i>Photo Not Available</i>	*A8200EB3	Speech Board, ADPCM, w/o Chips, E401, MRS	ABA26800ZZ1

© 2010, Otis Elevator Company (rev. November 2010)





PC BOARDS

©2010, Otis Elevator Company (rev. November 2010)

Image	Part Number	Description	Alt/Sub/Sup P/N
	A8200EB1	Speech Board, E401, MRS	ABA26800ZZ1
<i>Photo Not Available</i>	*8200EB5	Speech Board, OKI, E401, MRS, MRVF, E412	ABA26800ZZ1
<i>Photo Not Available</i>	ABA26800ZZ4	Speech, Male Voice, E401, E411, MRS	A8200EB4
<i>Photo Not Available</i>	RB326-010-55	Suppressor	
<i>Photo Not Available</i>	*RB326-010-53	Suppressor Board	RB326-010-73
<i>Photo Not Available</i>	RB326-010-54	Suppressor Board	RB326-010-50
<i>Photo Not Available</i>	RB326-010-70	Suppressor Board	
<i>Photo Not Available</i>	RB326-010-71	Suppressor Board	RB326-010-51
<i>Photo Not Available</i>	RB326-010-72	Suppressor Board	RB326-010-52
<i>Photo Not Available</i>	RB326-010-73	Suppressor Board	RB326-010-53
<i>Photo Not Available</i>	*RB326-010-50	Suppressor Board R	RB326-010-54
<i>Photo Not Available</i>	*RB326-010-51	Suppressor Board R	RB326-010-71
	RB326-010-52	Suppressor Board R	RB326-010-72
<i>Photo Not Available</i>	HT201733-1	Transducer I/O Board Assembly	
<i>Photo Not Available</i>	*HT200750-1	Transducer, Primary, E101	AAA21430L1
<i>Photo Not Available</i>	AAA21430L1	Transducer, Primary, Upgraded HT200750-1	
<i>Photo Not Available</i>	A8200AW1	Velocity Loop Board	
<i>Photo Not Available</i>	*LA46S2442-0460	Voltage Divider Board	
<i>Photo Not Available</i>	*LA46S2442-0470	Voltage Divider Board	
<i>Photo Not Available</i>	*LA46S2442-0490	Voltage Divider Board	
<i>Photo Not Available</i>	*LA46S2442-0500	Voltage Divider Board	
<i>Photo Not Available</i>	*LA46S2442-0520	Voltage Divider Board	
<i>Photo Not Available</i>	*LA46S2442-0530	Voltage Divider Board	
<i>Photo Not Available</i>	LA46S2442-0010	Voltage Divider Board	
<i>Photo Not Available</i>	LA46S2442-0080	Voltage Divider Board	

OTIS

Otis 101 & 401 (continued)

Image	Part Number	Description	Alt/Sub/Sup P/N
<i>Photo Not Available</i>	LA46S2442-0130	Voltage Divider Board	
<i>Photo Not Available</i>	LA46S2442-0140	Voltage Divider Board	
<i>Photo Not Available</i>	LA46S2442-0220	Voltage Divider Board	
<i>Photo Not Available</i>	LA46S2442-0480	Voltage Divider Board	
<i>Photo Not Available</i>	*HT201734-5	WL Relay I/O P	HT203101-2
<i>Photo Not Available</i>	LA46S1692-0010	Zero Current Detector	LA46S1692-0030
<i>Photo Not Available</i>	LA46S1692-0020	Zero Current Detector	LA46S1692-0040
	LA46S1692-0030	Zero Current Detector	LA46S1692-0010
	LA46S1692-0040	Zero Current Detector	LA46S1692-0020
	LA46S1692-0050	Zero Current Detector	
	LA46S1692-0060	Zero Current Detector	

© 2010, Otis Elevator Company (rev. November 2010)

PC BOARDS

Elevonic 311 & 411

Image	Part Number	Description	Alt/Sub/Sup P/N	Application
<i>Photo Not Available</i>	LA46S2690-0021	12SCR Controller Board		E311M/ E411M, E311MV/ E411MV Direct Drive
<i>Photo Not Available</i>	LA46S2690-0023	12SCR Controller Board		E311 / 411 M & MV Direct Drive Control- ler Panel
<i>Photo Not Available</i>	LA46S2686-2020	12SCR Gate Fir- ing/Voltage Divider Board		E311 / 411 M & MV Direct Drive Control- ler Panel
<i>Photo Not Available</i>	*AAA26800KK2	ADISS Board	AAA26800KK4	E311/411M
	*ABA26800KK3	ADISS Board	ABA26800KK4	E311M, E411M, E311MV, E411MV
<i>Photo Not Available</i>	ABA26800KK4	ADISS Board		E311M, E411M, E311MV, E411MV
	B9693MG1	ADISS Board		E411, E312
<i>Photo Not Available</i>	*AAA26800KK3	ADISS Board, Modi- fied AAA26800NR1 PC	ABA26800KK3	E311/411M
<i>Photo Not Available</i>	B9693MG2	ADISS Board. Supersedes A9693MG2		E411, E313
<i>Photo Not Available</i>	*AAA26800KK4	ADISS Kit: Includes AAA26800KK3 Board	ABA26800KK4	E311/411M

OTIS

Otis Elevonic 311 & 411 (continued)

Image	Part Number	Description	Alt/Sub/Sup P/N	Application
	AAA26800GG1	ANSI Speed Check Board		E311MV, E411MV
<i>Photo Not Available</i>	AAA21380M1	ANSI Speed Check Module Assembly		E311VF (MVS), GEM
<i>Photo Not Available</i>	GDA21270A4	RCBII Board	GEA21270A3 GHA21270A3	E311VF (MVS), GEM/411MMS
	GHA21270A3	RCBII Board		E311VF (MVS), GEM/411MMS
	AAB26810A1	Remote Station PC Board Assembly		E311M
<i>Photo Not Available</i>	ABA26800ABL001	Chime Board		E311VF (MVS), GEM
<i>Photo Not Available</i>	*AEA26800AAP001	Control Board	AFA26800AAP001	E411, GAMMA D
<i>Photo Not Available</i>	*AEA26800AAP002	Control Board	AFA26800AAP002	E411, GAMMA D
<i>Photo Not Available</i>	AFA26800AAP001	Control Board		E411, GAMMA D
<i>Photo Not Available</i>	AFA26800AAP002	Control Board		E411, GAMMA D

© 2010, Otis Elevator Company (rev. November 2010)

PC BOARDS

©2010, Otis Elevator Company (rev. November 2010)

Image	Part Number	Description	Alt/Sub/Sup P/N	Application
	AAA26800QM1	CPU		411MMS, MVE, E411
<i>Photo Not Available</i>	LA46S2691-0041	DBSS Board		E311M/ E411M, E311MV/ E411MV High Speed Ward Leonard
<i>Photo Not Available</i>	AAA21260AAC001	DBSS/HSWI Power Control Module (PCM)		E311M/ E411M/ E311MV/ E4311MV
<i>Photo Not Available</i>	SA14-193-770-567	DC Contactor, 125 V, 3TY7 Aux. Con- tact, LA E411		E411
	SA14-193-770-568	DC Rev Contactor, 125 V, 3TY7 Aux. Contact, LA E411		E411
<i>Photo Not Available</i>	*AAA26800KJ2	DISS Board	AAA26800KJ4	E311/411M
<i>Photo Not Available</i>	*B9693MB1	DISS Board	B9693MB2	E411, E311
<i>Photo Not Available</i>	ABA26800KJ4	DISS Board		E311MV, E411MV
	C9693MB2	DISS Board		E311, E411, E411M

OTIS

Otis Elevonic 311 & 411 (continued)

Image	Part Number	Description	Alt/Sub/Sup P/N	Application
<i>Photo Not Available</i>	*AAA26800KJ4	DISS Board, Modified AAA26800NP1 Board Kit	ABA26800KJ4	E311/411M
	C9693MB1	DISS Board. Replaces AAA26800NP1.		E311, E411, E411M
<i>Photo Not Available</i>	*ACA21290Y6	Drive Board for ETO, 90 Amp, 480 Volt	ACA21290BJ2	E411MVF, MVS, GEM
<i>Photo Not Available</i>	*ACA21290Y5	Drive Board for PAO, 90 Amp, 480 Volt	ACA21290BJ2	E411MVF, MVS, GEM
<i>Photo Not Available</i>	ACA21290M1	Drive Board, 120 Amp, 480 Volt	ACA21290BA2	E411MVF, MVS, GEM
<i>Photo Not Available</i>	ACA21290Y4	Drive Board, 90 Amp, 480 Volt	ABA21290BJ2 ACA21290BJ2	E411MVF, MVS, GEM
<i>Photo Not Available</i>	*ADA21290AP2	Drive Board, OVF, 140 Amp, 240 Volt		E411MVF, MVS, GEM, GEN2
<i>Photo Not Available</i>	ACA21290BM1	Drive Board, OVF, 210 Amp, 480 Volt		E411MVF, MVS, GEM, GEN2
<i>Photo Not Available</i>	ADA21290AK2	Drive Board, OVF, 70 Amp, 480 Volt		E411MVF, MVS, GEM, GEN2
<i>Photo Not Available</i>	ACA21290BJ2	Drive Board, OVF, 90 Amp, 480 Volt		E411MVF, MVS, GEM, GEN2
<i>Photo Not Available</i>	ACA21290BA4	Drive Board, OVF, for ETO, 120 Amp, 480 Volt		E411MVF, MVS, GEM, GEN2
<i>Photo Not Available</i>	ACA21290BA2	Drive Board, OVF, for NAO, 120 Amp, 480 Volt		E411MVF, MVS, GEM, GEN2
<i>Photo Not Available</i>	ADA26800MB1	Drive Board, VF		E411MVF, MVS, GEM, GEN2

© 2010, Otis Elevator Company (rev. November 2010)

PC BOARDS

©2010, Otis Elevator Company (rev. November 2010)

Image	Part Number	Description	Alt/Sub/Sup P/N	Application
<i>Photo Not Available</i>	LA46S2965-0011	Field Brake Assembly		E311/E411 Magnetek Direct Drive
<i>Photo Not Available</i>	LA46S2965-0021	Field Brake Assembly		E311/E411 Magnetek Direct Drive
<i>Photo Not Available</i>	LA46S2689-0061	Field Brake Control		E311 / 411 M & MV Direct Drive Con- troller Panel, Magnetek Direct Drive
<i>Photo Not Available</i>	AAA26800KP1	Filter Assembly		E311VF (MVS), GEM
<i>Photo Not Available</i>	AAA21380D1	Filter Module As- sembly		E311VF (MVS), GEM
	ABA26800XU1	Geared VF Drive Low Voltage Interface Board		E311VF (MVS), GEM
	ABA26800XU2	Geared VF Drive Low Voltage Interface Board		E311VF (MVS), GEM
<i>Photo Not Available</i>	LA46S2868-0030	Hall/Relay Interface Board		E311M/ E411M, E311MV/ E411MV High Speed Ward Leonard

OTIS

Otis Elevonic 311 & 411 (continued)

Image	Part Number	Description	Alt/Sub/Sup P/N	Application
<i>Photo Not Available</i>	LA46S2869-0011	H-Bridge Snubber Board		E311M/ E411M, E311MV/ E411MV High Speed Ward Leonard
	LA46S2685-0030	Heat Sink Assembly		E311M/ E411M
	LA46S2685-0040	Heat Sink Assembly		E311M/ E411M
<i>Photo Not Available</i>	ADA26800RB1	High Voltage Inter- face Board		E411MVF, MVS, GEM, GEN2
<i>Photo Not Available</i>	ADA26800VF1	High Voltage Inter- face Board		E411MVF, MVS, GEM, GEN2
<i>Photo Not Available</i>	AFA26800UD1	High Voltage Inter- face Board	AGA26800UD1	E411MVS, MVS, GEM
<i>Photo Not Available</i>	AFA26800UD2	High Voltage Inter- face Board	AGA26800UD2	E411MVS, MVS, GEM
<i>Photo Not Available</i>	AFA26800UD3	High Voltage Inter- face Board	AGA26800UD3	E411MVS, MVS, GEM
<i>Photo Not Available</i>	AGA26800UD1	High Voltage Inter- face Board		E411MVS, MVS, GEM
<i>Photo Not Available</i>	AGA26800UD2	High Voltage Inter- face Board		E411MVS, MVS, GEM

© 2010, Otis Elevator Company (rev. November 2010)

PC BOARDS

©2010, Otis Elevator Company (rev. November 2010)

Image	Part Number	Description	Alt/Sub/Sup P/N	Application
<i>Photo Not Available</i>	AGA26800UD3	High Voltage Inter- face Board		E411MVS, MVS, GEM
<i>Photo Not Available</i>	LA46S2871-0021	Interface Board		E311M/ E411M, E311MV/ E411MV High Speed Ward Leonard
<i>Photo Not Available</i>	*ADA26800MB5	Interface Board, 180 Amp, VF Drive AAA21290BB		E411MVF, MVS, GEM, GEN2
<i>Photo Not Available</i>	ABA26800ABV2	Interface Board, 32 Channel		E311M
<i>Photo Not Available</i>	AAA26800GM1	Load Weighing Inter- face Board Assembly		E311MV, E411MV
<i>Photo Not Available</i>	AAA26800LM1	LVDT		E311MV, E411MV
	AAA26800LB1	LWSS Processor Board	ABA26800LB1	MMS, MVF
<i>Photo Not Available</i>	ABA26800LB1	LWSS Processor Board		MMS, MVF
<i>Photo Not Available</i>	AEA639AZ2	Serial I/O Board	AEA639AZ5	E411, GAM- MA D
<i>Photo Not Available</i>	ACA26800ABB001	MCSS I/O Board		E311MV/ E411MV
<i>Photo Not Available</i>	ACA26800ABB002	MCSS I/O Board		E311MV/ E411MV
	ABA26800ABA002	MCSS Microproces- sor		E311MV, E411MV

OTIS

Otis Elevonic 311 & 411 (continued)

Image	Part Number	Description	Alt/Sub/Sup P/N	Application
	AAA26800MT1	Mod Remote Station Extender Board		E411MMS
<i>Photo Not Available</i>	JGA26801AAF002	Motion Control Board		E311MV, E411MV
<i>Photo Not Available</i>	*ABA26800XH1	Motion Logic III Board	ACA26800XH1	E411MMS
	ACA26800XH1	Motion Logic III Board		E411MMS
<i>Photo Not Available</i>	*ACA26800XH2	Motion Logic III Board	AAA27076AY2	E411MMS
	ABA26800AJV1	Motion Logic III Board		E411MMS
	ABA26800AJV2	Motion Logic III Board		E411MMS
	ABA26800AJV3	Motion Logic III Board		E411MMS

© 2010, Otis Elevator Company (rev. November 2010)

PC BOARDS

Image	Part Number	Description	Alt/Sub/Sup P/N	Application
<i>Photo Not Available</i>	AAA26800AJV1	Motion Logic III Board, E411MMS	ABA26800AJV1	MMS, MVF, GEN2
<i>Photo Not Available</i>	AAA26800AJV2	Motion Logic III Board, E411MMS	ABA26800AJV2	MMS, MVF, GEN2
<i>Photo Not Available</i>	LA46S2870-0012	Motor/Brake Snubber Board		E311M/ E411M, E311MV/ E411MV High Speed Ward Leonard
<i>Photo Not Available</i>	LA46S2692-0031	Power Supply Board		E311/E411 Magnetek Direct Drive
<i>Photo Not Available</i>	ADA26800VA1	Processor Board		E411MVF, MVS, GEM, GEN2
<i>Photo Not Available</i>	ABA26800QZ1	PVT Buffer Board		E411MV
<i>Photo Not Available</i>	LA46S2728-0041	Relay Interface Board		E311 / 411 M & MV Direct Drive Controller Panel, Magnetek Direct Drive
<i>Photo Not Available</i>	LA46S2728-0052	Relay Interface Board		E311/E411 Magnetek Direct Drive
<i>Photo Not Available</i>	AAA26800NL1	Resistor Network Board		E311MV, E411MV
<i>Photo Not Available</i>	A9693D1	Ring Car Board		E411, MRQ
<i>Photo Not Available</i>	AAA26800KC1	Ring Car Board 1A		E311MV, E411MV
<i>Photo Not Available</i>	*GCA21270A2	Ring Car Board II	GCA21270A3	E311, E411, E411M, GEM, MVS
<i>Photo Not Available</i>	*GCA21270A3	Ring Car Board II	GDA21270A4	E311, E411, E411M, GEM, MVS
<i>Photo Not Available</i>	*GEA21270A1	Ring Car Board II	GEA21270A3	E311, E411, E411M, GEM, MVS
<i>Photo Not Available</i>	GEA21270A3	Ring Car Board II	GFA21270A3 GHA21270A3	
<i>Photo Not Available</i>	GFA21270A3	Ring Car Board II	GEA21270A3 GGA21270A3	

OTIS

Otis Elevonic 311 & 411 (continued)

Image	Part Number	Description	Alt/Sub/Sup P/N	Application
<i>Photo Not Available</i>	GGA21270A3	Ring Car Board II	GGA21270A6 GHA21270A3	
<i>Photo Not Available</i>	GGA21270A6	Ring Car Board II	GGA21270A3	E311, E411, E411M, GEM, MVS
<i>Photo Not Available</i>	*GCA21270A1	Ring Car/LCSS Board	GCA21270A2	E311, E411, E411M, GEM, MVS
<i>Photo Not Available</i>	GCA23550B1	RS4 Gong Board		E311, E411, E411M, GEM, MVS
<i>Photo Not Available</i>	ABA26800KT1	Seismic Assembly		E311VF (MVS), GEM
<i>Photo Not Available</i>	ABB21380E1	Seismic Module		E311VF (MVS), GEM
<i>Photo Not Available</i>	LA46S2877-0022	Snubber Card		E311 / 411 M & MV Direct Drive Con- troller Panel, Magnetek Direct Drive
<i>Photo Not Available</i>	ABA26800KS1	Standby Power Ser- vice Board		E311VF (MVS), GEM
<i>Photo Not Available</i>	ABB21380F1	Standby Power Ser- vice Module		E311VF (MVS), GEM
<i>Photo Not Available</i>	A9693F1	Switch Module As- sembly	GCA26800AL1	E311VF (MVS), GEM, MVS, E411
<i>Photo Not Available</i>	GCA26800AL1	Switchover Module		E311VF (MVS), GEM/ 411MMS
<i>Photo Not Available</i>	*AEA26800AAP004	Tape Reader Board	AFA26800AAP004	E411, GAMMA D
<i>Photo Not Available</i>	AFA26800AAP004	Tape Reader Board		E411, GAM- MA D
<i>Photo Not Available</i>	*AAA26800NR1	ADISS PCB	B9693MG1	E311MV, E411MV
<i>Photo Not Available</i>	AAA26800NP1	DISS PCB		E311MV, E411MV
<i>Photo Not Available</i>	LA46S2686-2030	Voltage Divider Board		E311 / 411 M & MV Direct Drive Control- ler Panel

© 2010, Otis Elevator Company (rev. November 2010)



PC BOARDS

Elevonic 335M

Image	Part Number	Description	Alt/Sub/Sup P/N
<i>Photo Not Available</i>	AAA21255J120	Armature Interface (W) 100 A Drive Board	AAA21255J132
<i>Photo Not Available</i>	AAA21255J110	Armature Interface (W) 190 A Drive Board	AAA21255J132
<i>Photo Not Available</i>	AAA21255J132	Armature Interface Board	AAA21255J148
<i>Photo Not Available</i>	AAA21255J148	Armature Upgrade Kit, 100/190 Amp	
<i>Photo Not Available</i>	AAA21255J109	Drive Control Board	
<i>Photo Not Available</i>	AAA21255J14	Drive Panel Assembly, Motor Amps 100 2.0-40	
<i>Photo Not Available</i>	AAA21255J15	Drive Panel Assembly, Motor Amps 190 2.0-40	
<i>Photo Not Available</i>	AAA21255J16	Drive Panel Assembly, Motor Amps 300 2.0-40	
<i>Photo Not Available</i>	AAA21255J20	DSD 401 Drive	
<i>Photo Not Available</i>	AAA21255J21	DSD 401 Drive	
<i>Photo Not Available</i>	AAA21255J18	DSD-412 Drive Panel, 190 A ARM, 40A Field	
<i>Photo Not Available</i>	AAA21255J150	Field Upgrade Kit	
<i>Photo Not Available</i>	9693J1	Line Terminator Board	
<i>Photo Not Available</i>	9693J2	Line Terminator Board	
<i>Photo Not Available</i>	ACA26800MK2	Motion Logic Board, 50 Hz, E335M-MLB	
<i>Photo Not Available</i>	ACA26800MK1	Motion Logic Board, E335M-MLB	
	AAA21255J111	Motor Field Interface, 0.2-2.0 A Board	
	AAA21255J112	Motor Field Interface, 2.010 A Board	AAA21255J150
	AAA21255J113	Motor Field Interface, 6.3-16.7 A Board	
<i>Photo Not Available</i>	AAA21255J121	Snubber Capacitor (W) 100 A Board	
<i>Photo Not Available</i>	AAA21255J114	Snubber Capacitor Board	
<i>Photo Not Available</i>	AAB22439E4	Tape Reader Assembly, 335MW	
<i>Photo Not Available</i>	AAB22439E2	Tape Reader Subassembly	

OTIS





GAMMA D

Image	Part Number	Description	Alt/Sub/Sup P/N
<i>Photo Not Available</i>	*D9708AE1	GAMMA 160 Board	F9708AE3
<i>Photo Not Available</i>	*B9708BM1	Gamma D Processor	C9708BM2
	B9708BN1	Gamma I/O Board	
<i>Photo Not Available</i>	B9708BN2	I/O Board	
<i>Photo Not Available</i>	*A9693A3	Limited Car Board, GAMMA D, MRQ, EMO, TEMO	B9693A3
<i>Photo Not Available</i>	B9693A3	Limited Car Board	C9693A3
<i>Photo Not Available</i>	C9693A3	Limited Car Board	
	C9693A60	Limited Car Board	
<i>Photo Not Available</i>	*A9708BJ1	Power Pack	A9708BJ3
<i>Photo Not Available</i>	*B9708BM2	Processor Board	C9708BM2
	C9708BM2	Processor Board	
<i>Photo Not Available</i>	B9693AE1	Remote Station Extender Board, GAMMA D, COP	A9693AE1

© 2010, Otis Elevator Company (rev. November 2010)

PC BOARDS

©2010, Otis Elevator Company (rev. November 2010)

Image	Part Number	Description	Alt/Sub/Sup P/N
	A9693AE1	RSEB Board	B9693AE1
	F9708AE3	Speed Control Board	AAA26800ALQ1
<i>Photo Not Available</i>	AAA26800ALQ1	Speed Control Board	
	A9708BJ3	Thyristor Panel	
	A9708BJ4	Thyristor Panel	

OTIS

GEM, MVS

Image	Part Number	Description	Application
<i>Photo Not Available</i>	AAA21380M1	ANSI Speed Check Module Assembly	GEM, E311VF, MVS, HVS, GMP
<i>Photo Not Available</i>	AAA21380D1	Filter Module Assembly	GEM, E311VF, MVS, HVS, GMP
	JFA26801AAF105	MCB Board	GEM / MVS
	JGA26801AAF105	MCB Board	GEM / MVS
<i>Photo Not Available</i>	ABA26800TV1	Remote Station Board Assembly	GEM/MVS/COP
<i>Photo Not Available</i>	ABA26800TH1	Remote Station Extender (Card Reader)	GEM/MVS/COP

© 2010, Otis Elevator Company (rev. November 2010)

PC BOARDS

Fixtures

Image	Part Number	Description	Application
<i>Photo Not Available</i>	*BS-AS-100797-1	Computer Assembly, 1 Group	Lobby CRT
<i>Photo Not Available</i>	*7125L1	CPU Module Assembly	Lobby CRT
<i>Photo Not Available</i>	7125L4	CPU Module Assembly	Lobby CRT
<i>Photo Not Available</i>	AAA26800SD1	ICA Term. Hall Lantern Board Assembly	Hall Lantern
<i>Photo Not Available</i>	7125L5	I/O Assembly Display	Lobby CRT
<i>Photo Not Available</i>	7125L6	I/O Assembly, 1- and 2-Car Group	Lobby CRT
<i>Photo Not Available</i>	*7125L7	I/O Assembly, 3- and 4-Car Group	Lobby CRT
<i>Photo Not Available</i>	7125L8	I/O Assembly, 5- and 6-Car Group	Lobby CRT

IDS

Image	Part Number	Description	Alt/Sub/Sup P/N
<i>Photo Not Available</i>	8200AR1	Data Distribution Board	
<i>Photo Not Available</i>	8200AR2	IDS Distribution Board	
<i>Photo Not Available</i>	8200AT1	IDS General Purpose Interface	
<i>Photo Not Available</i>	*8200BB3	IDS Processor Board	
<i>Photo Not Available</i>	A8200AV1	IDS Temp Sensor Board	
<i>Photo Not Available</i>	*8200BB2	IDS with IC's Computer Board	8200BB3

OTIS

LR, LRV, LHM, LRV

Image	Part Number	Description	Alt/Sub/Sup P/N	Application
<i>Photo Not Available</i>	A8121D4	BM Board		LR
<i>Photo Not Available</i>	A8121D1	BP Board		LR
	8200AJ1	BP Door Operator Panel		LR, MRS
	E8121BE1	Button Interface Module		LRV4, LRS3
<i>Photo Not Available</i>	A8121D5	C-3074 Board		LR
<i>Photo Not Available</i>	A8128EF1	Cab Interface Board		LRV
<i>Photo Not Available</i>	A8121B2	Car or Hall Call Interface Board	A8121B2-TEMP	LR
	A8121P1	COM1 Printed Board		LR
<i>Photo Not Available</i>	8128EE1	Controller Interface Board		LRV5, LRV5L
<i>Photo Not Available</i>	AAA26800KX1	Controller Interface Board		LRV5, LHM
	AAA26800NZ1	Controller Interface Board		LHM/LRV5L

© 2010, Otis Elevator Company (rev. November 2010)

PC BOARDS

Image	Part Number	Description	Alt/Sub/Sup P/N	Application
<i>Photo Not Available</i>	A8121E4	Double Gong Board		LR
<i>Photo Not Available</i>	*B8121AX1	EMI Board	C8121AX1	LRV3, LRV4, LRS3
<i>Photo Not Available</i>	*A8121AW1	GMI Board, R/F	ABA07900AAA001	LRV3
<i>Photo Not Available</i>	*8200BE1	Gong Board	A8200BE1	LRV4, LRS
<i>Photo Not Available</i>	A8200BE1	Gong Board		LRV4, LRS
<i>Photo Not Available</i>	A8121AY1	Hall Button Interface (HBI)	ABA07900AAA001	LRV3
<i>Photo Not Available</i>	ABA07900AAA001	Hydro Retrofit Kit		LRV3
<i>Photo Not Available</i>	A8121D3	Interface Board		LR
<i>Photo Not Available</i>	*B8121BC1	Microcomputer Board	C8121BC1	LRS3
	D8121BC1	Microcomputer Board		LRS3
	A8121DY2	LRS3 Wiring Tester, w/Cables		LRS3
	E8121DB1	Microcontroller PC		LRS3
	F8121BC1	Microcontroller PC		LRS3
	C8121DB1	Microprocessor		LRV4
<i>Photo Not Available</i>	*C8211B1	MRVF Board	1F-7416BB1	LRV4
<i>Photo Not Available</i>	A8121Y3	MRVF-Board		LR
<i>Photo Not Available</i>	*AAA26800MZ1	Relay Board, LRVM	ABA26800MZ1	LRVM

OTIS

Otis LR, LRV, LHM, LRV (continued)

<i>Photo Not Available</i>	*C8121AX2	Relay Board, LRVM		LRVH, LRVM, LRV3, LRV4, LRS4
<i>Photo Not Available</i>	ABA26800MZ1	Relay Board, LRVM		LRVM
Image	Part Number	Description	Alt/Sub/Sup P/N	Application
	C8121AX1	Relay Board, LRVM		LRVH, LRVM, LRV3, LRV4, LRS3
<i>Photo Not Available</i>	A8121D2	Relay Driver Board, Latching Interface		LR
	AAB22439E6	Tape Reader Assembly		LVM
<i>Photo Not Available</i>	A8121Y1	Timer Board		LR
	A8121Y2	Timer Board		LR
<i>Photo Not Available</i>	B8121BJ1	Touch Tone Interface Board		LRS3
<i>Photo Not Available</i>	1F-7416BB1	VF DLU Upgrade Kit		LRV4

© 2010, Otis Elevator Company (rev. November 2010)

PC BOARDS

MPGC

Image	Part Number	Description	Alt/Sub/Sup P/N
<i>Photo Not Available</i>	D8121BX1	9-Channel Board	
	D8121BX2	9-Channel Board	
<i>Photo Not Available</i>	*A8121BM1	MPGC Board	B8121BM1
<i>Photo Not Available</i>	A8121BS1	MPGC Board	
	A8121BT1	MPGC Board	
<i>Photo Not Available</i>	A8121CB1	MPGC Board	
<i>Photo Not Available</i>	A8121CB3	MPGC Board	
	B8121BK1	MPGC Board	
	B8121BM1	MPGC Board	
<i>Photo Not Available</i>	B8121BM3	MPGC Board	
<i>Photo Not Available</i>	*A8121CB4	MPGC Board EN50306	
<i>Photo Not Available</i>	*B8121BM5	Universal Input Board	

OTIS

MRQ, EMO, TEMO

Image	Part Number	Description	Alt/Sub/Sup P/N	Application
<i>Photo Not Available</i>	A8128DP1	Counter Board		MRQ
<i>Photo Not Available</i>	2700CAA5	Drive w/o Logic Board Assembly		MRQ
<i>Photo Not Available</i>	B9693A3	Limited Car Board	C9693A3	MRQ, EMO, TEMO, GAMMA D
<i>Photo Not Available</i>	C9693A3	Limited Car Board		MRQ, EMO, TEMO, GAMMA D
	C9693A60	Limited Car Board		MRQ, EMO, TEMO, GAMMA D
<i>Photo Not Available</i>	2700CAA6	Logic Board Assembly & Instructions		MRQ
	B8128DR1	SC I/O Board Assembly		MRQ
<i>Photo Not Available</i>	10260P10	Spec 60 Drive		MRQ
	B8128DR1	Speed Check I/O Board		MRQ
<i>Photo Not Available</i>	B8128DR2	Speed Check I/O Board		MRQ

© 2010, Otis Elevator Company (rev. November 2010)

PC BOARDS

MRS, MRV, MRVF, LR

Image	Part Number	Description	Alt/Sub/Sup P/N	Application
<i>Photo Not Available</i>	8128CN1	Amplifier Assembly Board		MRVF
<i>Photo Not Available</i>	*A8211A1	Back Panel Board	8211A1	MRVF
<i>Photo Not Available</i>	*7416E2	Base Drive Assembly, Transistor Phase A	AAA27076AS1	MRVF
<i>Photo Not Available</i>	*7416E4	Base Drive Assembly, Transistor Phase C	AAA27076AS1	MRVF
<i>Photo Not Available</i>	*A8211F1	Base Drive Phase A Board	C8211F1	MRVF
<i>Photo Not Available</i>	*A8211F2	Base Drive Phase A Board	C8211F2	MRVF
<i>Photo Not Available</i>	*7416E3	Base Drive Subassembly	AAA27076AS1	MRVF
<i>Photo Not Available</i>	A628G1	Battery Charger		MRVF
<i>Photo Not Available</i>	C628B1	Battery Charger		MRVF
<i>Photo Not Available</i>	A8121AL2	BM Board		MRVF, MRS, LR
<i>Photo Not Available</i>	*A8124AL1	Board		MRS, MRVF



8211A1

Board

MRVF

Photo Not Available

*A8121AH6

BP-MRVF Board

B8121AH2

MRS, LR

Photo Not Available

*A8211F3

Buffer Board

C8211F3

MRVF



A8121AT1

Buffer Board

MRVF

Photo Not Available

*A621G1

Carrier Power Supply

B621G1

MRVF

Photo Not Available

B621G1



Carrier Power Supply

C621G1

MRVF

OTIS

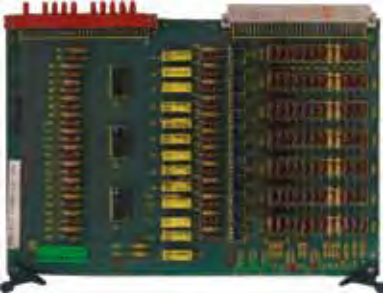

Otis MRS, MRV, MRVF, LR (continued)

Image	Part Number	Description	Alt/Sub/Sup P/N	Application
	C621G1	Carrier Power Supply		MRVF
<i>Photo Not Available</i>	8128CM1	Comparator Assembly Board		MRVF
<i>Photo Not Available</i>	*8211B1	DLU Board	A8211B1	MRVF
<i>Photo Not Available</i>	*A8211D1	DLU Board	B8211D1	MRVF
<i>Photo Not Available</i>	*B8211E1	EMI Board	1F-7416BB1	MRVF
	C8211F1	EN50150 Board		MRVF
<i>Photo Not Available</i>	C8211F2	EN50150 Board		MRVF
<i>Photo Not Available</i>	C8211F3	EN50150 Board		MRVF
<i>Photo Not Available</i>	*A8211D2	Freq & Amp Board	B8211D1	MRVF
<i>Photo Not Available</i>	A8121AE1	Hall Stack Board		MRS, LR
	B9708BF1	Impulse Transformer Board		MRV
<i>Photo Not Available</i>	B9708BF2	Impulse Transformer Board		MRV
<i>Photo Not Available</i>	B9708BF3	Impulse Transformer Board		MRV
	9708AG1	Input Interface Board		MRV

© 2010, Otis Elevator Company (rev. November 2010)

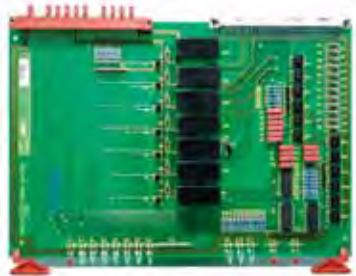

PC BOARDS

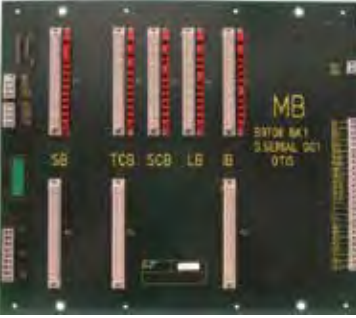
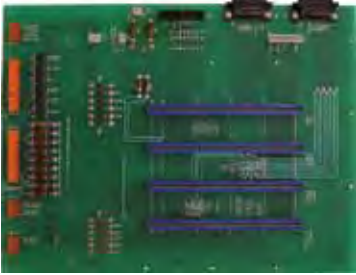
©2010, Otis Elevator Company (rev. November 2010)

Image	Part Number	Description	Alt/Sub/Sup P/N	Application
	9708BH1	Interface Board		MRV
<i>Photo Not Available</i>	*A8211B1	Inverter Control Board	1F-7416BB1	MRVF
<i>Photo Not Available</i>	AAA27076AS1	Inverter Power Module Retrofit Kit		MRVF
<i>Photo Not Available</i>	*9708AB1	Logic Board	CYX9708AB1	MRV
<i>Photo Not Available</i>	*B9708AD2	Logic Board	C9708AD2	MRV
<i>Photo Not Available</i>	*C9708AD1	Logic Board		MRV
	C9708AD2	Logic Board		MRV
	B9708BK1	Mother Board		MRV, Gamma 160s
	8211A1	Mother Board		MRVF

OTIS

Otis MRS, MRV, MRVF, LR (continued)

Image	Part Number	Description	Alt/Sub/Sup P/N	Application
<i>Photo Not Available</i>	*C8211C1	MRVF Board	1F-7416BB1	MRVF
<i>Photo Not Available</i>	A8121AA11	MRVF Board	A8121AA15 A8121AA18 A8121AA19 A8121AA13 A8121AA20 A8121AA17	MRVF
<i>Photo Not Available</i>	A8121AA13	MRVF Board	A8121AA17 A8121AA19 A8121AA20	MRVF
<i>Photo Not Available</i>	A8121AA15	MRVF Board	A8121AA17 A8121AA20	MRVF
<i>Photo Not Available</i>	A8121AA17	MRVF Board	A8121AA20	MRVF
<i>Photo Not Available</i>	A8121AA18	MRVF Board	A8121AA19 A8121AA20	MRVF
<i>Photo Not Available</i>	A8121AA19	MRVF Board	A8121AA20	MRVF
<i>Photo Not Available</i>	A8121AA20	MRVF Board		MRVF
<i>Photo Not Available</i>	A9708AH1	Output Interface Board		MRV
<i>Photo Not Available</i>	*9708BJ1	Power Pack w/Fan	A9708BJ3	MRV
<i>Photo Not Available</i>	*621J1	Power Supply	A621J1	MRVF
	B9708AF1	Power Supply Board		MRV
	A621J1	Power Supply, Multi-Output, DC		MRVF
<i>Photo Not Available</i>	621W1	Primary Power Supply (PPS)		MRVF
<i>Photo Not Available</i>	C8121CH1	PWM Board		MRVF
<i>Photo Not Available</i>	C8121CH2	PWM Board		MRVF

© 2010, Otis Elevator Company (rev. November 2010)

PC BOARDS

©2010, Otis Elevator Company (rev. November 2010)

Image	Part Number	Description	Alt/Sub/Sup P/N	Application
	A8121AR1	Reader Card		MRVF
<i>Photo Not Available</i>	*B8121AM1	Receiver Board	C8121AM1	MRS, MRVF
<i>Photo Not Available</i>	C8121AM1	Receiver Board		MRVF
<i>Photo Not Available</i>	*7596B1	Repair And Return Board		MRVF
<i>Photo Not Available</i>	*C9708AE1	Speed Control Board	F9708AE2	MRV
<i>Photo Not Available</i>	*F9708AE1	Speed Control Board	F9708AE2	MRV
	F9708AE3	Speed Control Board	AAA26800ALQ1	MRV
<i>Photo Not Available</i>	AAA26800ALQ1	Speed Control Board		MRV
<i>Photo Not Available</i>	F9708AE2	Speed Control Board	F9708AE3	MRV, MRVF
<i>Photo Not Available</i>	*A8211C1	Speed Control Board	1F-7416BB1	MRVF
<i>Photo Not Available</i>	*E9708AE1	Speed Control Board		MRVF
<i>Photo Not Available</i>	*A8211E1	Speed Dictation Board	1F-7416BB1	MRVF
	8128GE3	Stepper Board Assembly, Electronic		MRVF, MRS
<i>Photo Not Available</i>	8128GE2	Stepper Board, 8 Relays		MRVF, MRS
<i>Photo Not Available</i>	CYX9708AB1	Thyristor Control		MRVF
<i>Photo Not Available</i>	*B9708AB1	Thyristor Control Board	C9708AB1	MRV
<i>Photo Not Available</i>	*9708AL1	Thyristor Panel		MRV
<i>Photo Not Available</i>	*9708BJ2	Thyristor Panel	A9708BJ2	MRV
	A9708BJ3	Thyristor Panel		MRV

OTIS

Otis MRS, MRV, MRVF, LR (continued)

Image	Part Number	Description	Alt/Sub/Sup P/N	Application
<i>Photo Not Available</i>	*B9708BJ2	Thyristor Panel		MRV, GAMMA D
<i>Photo Not Available</i>	A8121AA3	Timer Board	A8121AA9	MRS, LR
<i>Photo Not Available</i>	A8121AA7	Timer Board	A8121AA10	MRS, LR
<i>Photo Not Available</i>	A8121AA8	Timer Board	A8121AA9 A8121AA10	
<i>Photo Not Available</i>	A8121AB1	Timer Board		MRS, LR
<i>Photo Not Available</i>	A8121AL1	Timer Board		MRVF, MRS, LR
<i>Photo Not Available</i>	A8121AL12	Timer Board		MRVF, MRS, LR
<i>Photo Not Available</i>	A8121AL13	Timer Board		MRVF, MRS, LR
<i>Photo Not Available</i>	A8121AL23	Timer Board		MRVF, MRS, LR
<i>Photo Not Available</i>	A8121AL3	Timer Board		MRVF, MRS, LR
<i>Photo Not Available</i>	A8121AL24	Timer Board		MRVF, MRS, LR
<i>Photo Not Available</i>	A8121AL4	Timer Board		MRVF, MRS, LR
<i>Photo Not Available</i>	A8121AL7	Timer Board		MRVF, MRS, LR
	A8121AA9	Timer Board, BM	A8121AA10	MRS, LR
<i>Photo Not Available</i>	*A8121AA2	Timer Board	A8121AA7	MRS, LR
<i>Photo Not Available</i>	*A8121AA4	Timer Board	A8121AA10	MRS, LR
<i>Photo Not Available</i>	*A8121AA6	Timer Board	A8121AA10 A8121AA7	MRS, LR
<i>Photo Not Available</i>	A8121AA1	Timer Board	A8121AA9 A8121AA10 A8121AA3 A8121AA5 A8121AA7 A8121AA8	MRS, LR

© 2010, Otis Elevator Company (rev. November 2010)

PC BOARDS

©2010, Otis Elevator Company (rev. November 2010)

Image	Part Number	Description	Alt/Sub/Sup P/N	Application
<i>Photo Not Available</i>	A8121AA2	Timer Board	A8121AA9 A8121AA6 A8121AA3 A8121AA10	MRS, LR
<i>Photo Not Available</i>	A8121AA4	Timer Board	A8121AA5 A8121AA6 A8121AA7	MRS, LR
<i>Photo Not Available</i>	A8121AL5	Timer Board		MRVF, MRS, LR
<i>Photo Not Available</i>	*A8121AL10	Timer Board	A8121AL24	MRVF, MRS, LR
<i>Photo Not Available</i>	A8121AA10	Timer Board, MPO		MRS, LR
<i>Photo Not Available</i>	*A8121AA5	Timer Board	A8121AA10 A8121AA7	MRS, LR
<i>Photo Not Available</i>	B8121AH1	Vacuum Fluorescent & Speech (VFSB) Board		MRS, MRVF
<i>Photo Not Available</i>	*B8121AH2	Vacuum Fluorescent & Speech (VFSB) Board w/Program Chip	AAA8121W1	MRS, MRVF
<i>Photo Not Available</i>	*A8121AH2	Vacuum Fluorescent and Speech Board	B8121AH2	MRS, LR
	B8211D1	VF Freq & Amp Board	A8211D2	MRVF
<i>Photo Not Available</i>	*D8211C1	VF Speed Control Board	E8211C1	MRVF
	E8211C1	VF Speed Control Board		MRVF

OTIS

Otis MRS, MRV, MRVF, LR (continued)

Image	Part Number	Description	Alt/Sub/Sup P/N	Application
<i>Photo Not Available</i>	*D8211E1	VF Speed Dictation Board	E8211E1	MRVF
	E8211E1	VF Speed Dictation Board		MRVF
<i>Photo Not Available</i>	*7416E1	W57795 Drive Board	AAA27076AS1	MRVF
<i>Photo Not Available</i>	*AYX-C9708AE1	WM Board 215 D		MRV

© 2010, Otis Elevator Company (rev. November 2010)

PC BOARDS

VIP260

Image	Part Number	Description	Alt/Sub/Sup P/N
<i>Photo Not Available</i>	*A8119AT1	BM.Board	
<i>Photo Not Available</i>	*A8114AA5	Board	
<i>Photo Not Available</i>	*A8114C3	Board	
<i>Photo Not Available</i>	*A8114C4	Board	
<i>Photo Not Available</i>	*A8114K3	Board	
<i>Photo Not Available</i>	*A8114K4	Board	
<i>Photo Not Available</i>	*A8119AN1	Board	
<i>Photo Not Available</i>	*A8119AP2	Board	
<i>Photo Not Available</i>	*A8202H1	Board	
<i>Photo Not Available</i>	A8111B1	Board	
<i>Photo Not Available</i>	A8111B3	Board	
<i>Photo Not Available</i>	A8111B4	Board	
<i>Photo Not Available</i>	A8111B5	Board	
<i>Photo Not Available</i>	A8111B7	Board	
<i>Photo Not Available</i>	A8111D2	Board	
<i>Photo Not Available</i>	A8112D1	Board	

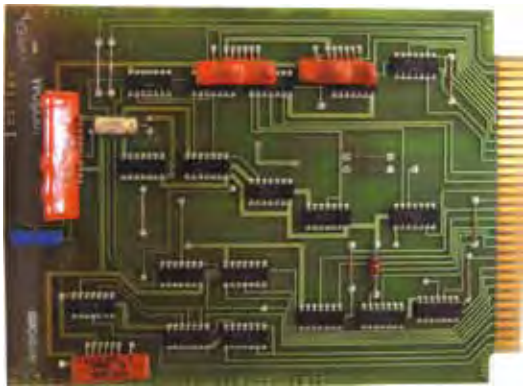

A8112G1 Board

Photo Not Available

A8112H1 Board

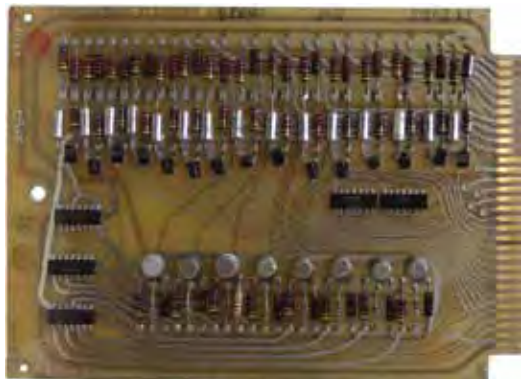

A8114A1 Board

Photo Not Available

A8114AA1 Board

OTIS

Otis VP260 (continued)

Image	Part Number	Description	Alt/Sub/Sup P/N
<i>Photo Not Available</i>	A8114AA10	Board	
<i>Photo Not Available</i>	A8114AA11	Board	
<i>Photo Not Available</i>	A8114AA3	Board	
<i>Photo Not Available</i>	A8114AB1	Board	
<i>Photo Not Available</i>	A8114AB2	Board	
<i>Photo Not Available</i>	A8114AD1	Board	
<i>Photo Not Available</i>	A8114AD4	Board	
<i>Photo Not Available</i>	A8114B1	Board	
<i>Photo Not Available</i>	A8114B2	Board	
<i>Photo Not Available</i>	A8114B3	Board	
<i>Photo Not Available</i>	A8114B4	Board	
<i>Photo Not Available</i>	A8114B5	Board	
<i>Photo Not Available</i>	A8114C1	Board	
<i>Photo Not Available</i>	A8114C2	Board	
<i>Photo Not Available</i>	A8114C5	Board	
<i>Photo Not Available</i>	A8114E1	Board	
<i>Photo Not Available</i>	A8114E2	Board	

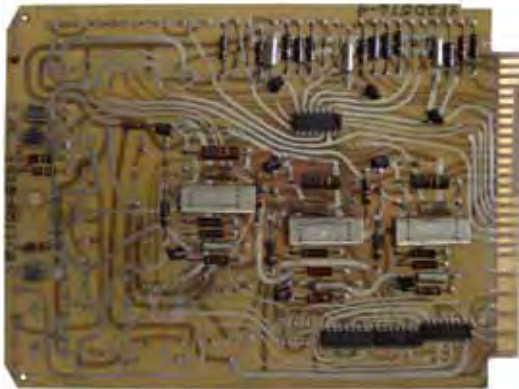

A8114E3 Board

Photo Not Available A8114E4 Board



A8114E5 Board

© 2010, Otis Elevator Company (rev. November 2010)

PC BOARDS

Image	Part Number	Description	Alt/Sub/Sup P/N
<i>Photo Not Available</i>	A8114F1	Board	
<i>Photo Not Available</i>	A8114G1	Board	
<i>Photo Not Available</i>	A8114K1	Board	
<i>Photo Not Available</i>	A8114K5	Board	
<i>Photo Not Available</i>	A8116B1	Board	
<i>Photo Not Available</i>	A8116B2	Board	
<i>Photo Not Available</i>	A8116B3	Board	
<i>Photo Not Available</i>	A8117A1	Board	
<i>Photo Not Available</i>	A8117A2	Board	
<i>Photo Not Available</i>	A8119AT2	BP Board	
<i>Photo Not Available</i>	*A8119AM2	Component Board	
<i>Photo Not Available</i>	*A8119AN3	Component Board	
<i>Photo Not Available</i>	A8119AM1	Component Board	
<i>Photo Not Available</i>	A8119AN2	Component Board	
<i>Photo Not Available</i>	*A8203A3	Field Interface Board	A8203A1
<i>Photo Not Available</i>	A8203A1	Field Interface Board	
<i>Photo Not Available</i>	A8114D1	Interface Board	
<i>Photo Not Available</i>	A8114D2	Interface Board	
<i>Photo Not Available</i>	A8114D3	Interface Board	
<i>Photo Not Available</i>	A8114D4	Interface Board	
<i>Photo Not Available</i>	A8114D5	Interface Board	
<i>Photo Not Available</i>	A8116B4	Mechanical Hall Call Register Board	
<i>Photo Not Available</i>	A8111B2	PC Panel	
<i>Photo Not Available</i>	A8117A3	PC Panel	
<i>Photo Not Available</i>	A8117A4	PC Panel	
<i>Photo Not Available</i>	*8200A1	Readout Assembly	AAA26800UA1
<i>Photo Not Available</i>	AAA26800UA1	Readout, Alpha Numeric	
<i>Photo Not Available</i>	*A8118A1	Regulator Board	AAA26800RE1
<i>Photo Not Available</i>	A8119AL2	Relay Board	
<i>Photo Not Available</i>	A8114AA7	Supplementary Interface Function Board	
<i>Photo Not Available</i>	A8119AT4	Timer Board	

OTIS

Miscellaneous

Image	Part Number	Description	Alt/Sub/Sup P/N	Application
	ADA26800RD1	Aut-O-Safe Board		AUT-O-SAFE
<i>Photo Not Available</i>	*9673AF1	Board		
<i>Photo Not Available</i>	*A9673AF2	Board		
<i>Photo Not Available</i>	*A9673W3	Board		
<i>Photo Not Available</i>	*C9673T4	Board		
<i>Photo Not Available</i>	*D9673T4	Board		
	B8128EF1	Cab Interface Board		
	AAA26800XF1	CLQL Door Operator Control Board		Door
<i>Photo Not Available</i>	*AAA00639AAE002	Computer w/Keyboard		EMS
<i>Photo Not Available</i>	A8201P1	Control PC Board		7660 Door Operator
	AAA24350AE1	Drive Subassembly		

© 2010, Otis Elevator Company (rev. November 2010)

PC BOARDS

©2010, Otis Elevator Company (rev. November 2010)

Image	Part Number	Description	Alt/Sub/Sup P/N	Application
	ABA26800HT1	ELD Buffer Board Assembly		ELD
<i>Photo Not Available</i>	AFA26800AAS001	ELD Interface Board Assembly	AAA26800SG1	ELD
<i>Photo Not Available</i>	ABA26800AAT002	ELD Remote Station Interface Board Assembly		ELD
	AAA26800VT1	Electronic Door Restrictor Board		Door
<i>Photo Not Available</i>	AAA26800SG1	Elevator Display Controller		EDC
<i>Photo Not Available</i>	*7900AX1	ERU, LRV 3, 4, 5		ERU, LRV3,4, LRS
	GAA26800AR2	Escalator Control Board		Escalator



OTIS

Otis Miscellaneous Boards (continued)

Image	Part Number	Description	Alt/Sub/Sup P/N	Application
	CAA26800B1	ESMCDO Board-Arrg#1		
	CAA26800B2	ESMCDO Board-Arrg#2		
	AAA26800RV1	Hall Lantern Board Assembly		COP
<i>Photo Not Available</i>	AAA26800RV2	Hall Lantern Board Assembly		COP
	AFA26800KE3	HPDS Control Board Assembly		Door Operator
	AFA26800KE4	HPDS Control Board Assembly		Door Operator

© 2010, Otis Elevator Company (rev. November 2010)

PC BOARDS

Image	Part Number	Description	Alt/Sub/Sup P/N	Application
<i>Photo Not Available</i>	A8212A1	IEE Retrofit Mounting Assembly		IEE
<i>Photo Not Available</i>	AAA639CH1	Internal PC Hard Disk Drive, EIDE Interface		EMS
	AEA26800QA7	LAMBDA 2 Board Assembly		Door Detector
<i>Photo Not Available</i>	*C0NC-392	Opto Reader Board 3.0		
<i>Photo Not Available</i>	*6840CH1	Panel		UMV
<i>Photo Not Available</i>	*6840AY1	Panel Assembly	6840CH1	UMV
<i>Photo Not Available</i>	J06840NS1	Relay Unit Board		
<i>Photo Not Available</i>	BSAS800485-3	REM Slave Board		REM
<i>Photo Not Available</i>	*9693AE1	Remote Station Extender	9693AE2	MCS Controller
<i>Photo Not Available</i>	*A8124PB1	Repair & Return Board		
	A9693D2	Ring Card Board		EMS
	D8211B1	VF-Inverter Control Assembly		7416A MRVF Motion Controller & 7415A MRVF Battery Box

OTIS

Reliance

Image	Part Number	Description	Alt/Sub/Sup P/N	Application
<i>Photo Not Available</i>	RELI0-51831-6	CVTG Board	HGTN3-40290-59	MICONIC V
<i>Photo Not Available</i>	RELI0-52823	DFSA Board	HGTN3-40290-62	S6RFM
<i>Photo Not Available</i>	RELI0-52808	OLVC Board - S6RFM Static Drive	HGTN3-40290-60	S6RFM
<i>Photo Not Available</i>	*RELI0-51874	SSCA Board, Reliance Drive	HGTN0-51874	SSCA
<i>Photo Not Available</i>	*RELI0-51874-2	SSCC Board, Reliance Drive	HGTN3-40290-58	SSCC

Schindler

321A Hydro, 321A/330A

Image	Part Number	Description	Alt/Sub/Sup P/N	Application
<i>Photo Not Available</i>	SCHD225825	CIO		
<i>Photo Not Available</i>	SCHD224476	CIOHNA	SCHD225212	321A/330A
<i>Photo Not Available</i>	SCHD222834	CPB/AUXF	SCHD224476	321A Hydro
<i>Photo Not Available</i>	SCHD222831	CRIP	SCHD223956	321A Hydro
<i>Photo Not Available</i>	SCHD223956	CRIPHNA 1	SCHD225313	321A Hydro
<i>Photo Not Available</i>	SCHD225445	CRIPHNA 4 w/Access		321A/330A
<i>Photo Not Available</i>	SCHD225313	CRIPHNA 4 w/o Access		321A/330A
<i>Photo Not Available</i>	SCHD222971	GCIO 360	SCHD590862	
<i>Photo Not Available</i>	SCHD225445	321A/330A		
<i>Photo Not Available</i>	SCHD590862	GCIO 360		321A/330A
<i>Photo Not Available</i>	SCHD222837	HPBHNA		321A/330A
<i>Photo Not Available</i>	SCHD225212	MCIO	SCHD225825	321A/330A
<i>Photo Not Available</i>	SCHD222836	P/I Board 24 Volt Push-button	SCHD222837	321A/330A

Escalator

Image	Part Number	Description	Alt/Sub/Sup P/N	Application
<i>Photo Not Available</i>	SCHDSME438517	Comblight Assembly, 24 Volt, 60 Hertz LED		SWE Escalator
	SCHDSSA897200	Lftng Solenoid, 110 Volt		SWE / 9300 Escalator
<i>Photo Not Available</i>	SCHD090596S059	Processor / Motherboard	SCHDSY387600	SWE Escalator
<i>Photo Not Available</i>	SCHDSY387600	Processor / Motherboard		SWE Escalator



OTIS

Goldflight

Image	Part Number	Description	Alt/Sub/Sup P/N	Application
<i>Photo Not Available</i>	SCHD3-40290-10C	Amplifier Board	HGTN3-40290-10	Goldflight
<i>Photo Not Available</i>	SCHD3-40281-07	GMG Amp Board	HGTN3-40281-07	Goldflight MG
<i>Photo Not Available</i>	SCHD3-40267-48	Pattern Board	HGTN3-40267-48	Goldflight

PC BOARDS

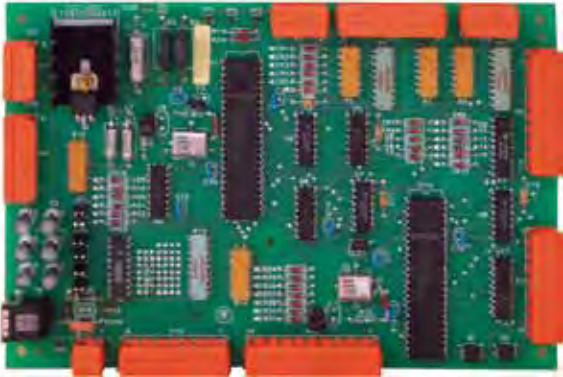
Miconic 300A

Image	Part Number	Description	Alt/Sub/Sup P/N
<i>Photo Not Available</i>	*WEST998C247H11	CIO	WEST998C247H14
	WEST998C247H14	CIO	SCHD225088
<i>Photo Not Available</i>	*WEST998C246H11	MIO	WEST998C246H12
	WEST998C246H12	MIO	
<i>Photo Not Available</i>	*WEST998C245H22	PIB	
<i>Photo Not Available</i>	WEST998C245H11	PIB	WEST998C245H12
<i>Photo Not Available</i>	WEST998C245H12	PIB	WEST998C245H22
<i>Photo Not Available</i>	*WEST998C272H11	REL	WEST998C272H12
<i>Photo Not Available</i>	WEST998C272H12	REL	WEST998C272H13
	WEST998C272H13	REL	
<i>Photo Not Available</i>	SCHD225088	SCIO	

OTIS

Schindler Miconic 300A (continued)

Image	Part Number	Description	Alt/Sub/Sup P/N
	WEST998C238H11	V2V Board, Miconic AM VFAC	WEST998C238H12
<p><i>Photo Not Available</i></p>	WEST998C238H12	V2V Board, Miconic AM VFAC	
<p><i>Photo Not Available</i></p>	WEST998C225H12	VEC	

© 2010, Otis Elevator Company (rev. November 2010)

PC BOARDS

Miconic A



Image	Part Number	Description	Alt/Sub/Sup P/N	Application
<i>Photo Not Available</i>	SCHD224310	SETS	SCHD225881	Miconic A
<i>Photo Not Available</i>	SCHD225881	SETS		Miconic A
<i>Photo Not Available</i>	SCHD224213	SHVM		Miconic A, MPH II
<i>Photo Not Available</i>	SCHD225723	SMTV	WEST998C197H13	Epoch II VA, Miconic A
<i>Photo Not Available</i>	SCHD2897C96G01	SPB	SCHD998C149H12	Miconic A
<i>Photo Not Available</i>	SCHD998C149H12	SPB		Miconic A

QKS Operator

Image	Part Number	Description	Alt/Sub/Sup P/N	Application
<i>Photo Not Available</i>	*SCHD223824	STDC	SCHD223825	QKS Operator
	SCHD223825	STDC		QKS Operator
<i>Photo Not Available</i>	SCHD225621	TDC	SCHD223825	QKS Operator

OTIS

Miscellaneous

Image	Part Number	Description	Alt/Sub/Sup P/N	Application
<i>Photo Not Available</i>	SCHD3-40229-94	Amplifier	HGTN3-40229-94	Model V
<i>Photo Not Available</i>	SCHD3-40179-87	ELC	HGTN3-40179-87	EVC/ELC
<i>Photo Not Available</i>	SCHD3-40179-99	ELC	HGTN3-40179-99	Model V
<i>Photo Not Available</i>	SCHD3-40267-66	Hydro-A Board	HGTN3-40267-66	Hydro
<i>Photo Not Available</i>	SCHD7283C79G01	MTA	WEST998C280H11	MTA Button Fixture
<i>Photo Not Available</i>	SCHD444561	PE80 Board	SCHD455469	
<i>Photo Not Available</i>	SCHD455469	PE-8MB Board		
<i>Photo Not Available</i>	SCHD7283C82H01	RAW Board	WEST998C280H11	
	SCHD225094	SFCB		MPH I, II Hydro
<i>Photo Not Available</i>	SCHD225515	SMHC		MPH II Hydro
	SCHD224371	SSCM		
<i>Photo Not Available</i>	SCHD225053	SSCM		
<i>Photo Not Available</i>	SCHD225054	SSCM		
<i>Photo Not Available</i>	SCHD8544C48H01	Westinghouse Phase Protec- tor (PRD)		

© 2010, Otis Elevator Company (rev. November 2010)

Swift

Swift 5000 Modmaster with 3412 Drive

Image	Part Number	Description	Alt/Sub/Sup P/N	Application
<i>Photo Not Available</i>	LA46S2592-0010	12 Channel Firing Board, SCR Drive		With 3412 Drive
<i>Photo Not Available</i>	LA46S2439-0130	12 SCR Board (165/509 V), SCR Drive		With 3412 Drive
<i>Photo Not Available</i>	*LA46S2439-0040	12 SCR Board		
<i>Photo Not Available</i>	LA46S2975-0302	Dover DSD 412 Drive Control Board		With 3412 Drive
<i>Photo Not Available</i>	LA46S2740-0020	Elevator Interface Board, SCR Drive		With 3412 Drive
<i>Photo Not Available</i>	LA46S3046-0030	Field Interface Board	AAA21255J150	With 3412 Drive
<i>Photo Not Available</i>	LA46S2483-0060	Field Regulator Assembly 5-25 Amp Field		With 3412 Drive
<i>Photo Not Available</i>	LA46S2483-0050	Field Regulator Assembly, 1-18 Amp Field		With 3412 Drive
<i>Photo Not Available</i>	LA46S2484-0020	Field Regulator Power Board		
<i>Photo Not Available</i>	LA46S2485-0021	Field Regulator Signal Board		
<i>Photo Not Available</i>	LA46S2263-0020	Power Supply Board		With 3412 Drive
<i>Photo Not Available</i>	LA46S2477-3020	Regulator Board		With 3412 Drive
<i>Photo Not Available</i>	LA46S2265-0012	Snubber Network		With 3412 Drive
<i>Photo Not Available</i>	LA46S2265-0020	Snubber, AC		With 3412 Drive

OTIS



Thames Valley

Image	Part Number	Description
<i>Photo Not Available</i>	*THAMSP27180-CPU2D	CPU Board

Thyssen-Krupp



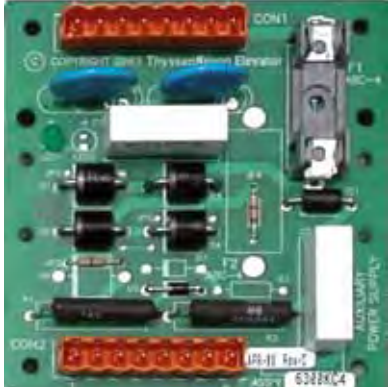

TAC 20

©2010, Otis Elevator Company (rev. November 2010)

Image	Part Number	Description	Alt/Sub/Sup P/N
<i>Photo Not Available</i>	THSN6300KY9	188E CPU Simplex, w/o Serial Channels	DOVR9782576
<i>Photo Not Available</i>	THSN6300LR3	AC/DC Current Regulator Board	
	THSN6300KC3	Auxiliary Power Supply Card, 115 VAC	
	THSN6300KC4	Auxiliary Power Supply Card, 150 VDC, APS5	
	THSN6300KC6	Auxiliary Power Supply Card, 48 VDC, APS	

OTIS

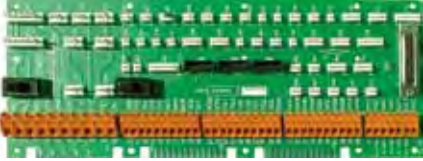
Thyssen-Krupp TAC 20 (continued)

Image	Part Number	Description	Alt/Sub/Sup P/N
	THSN6300KC5	Auxiliary Power Supply Card, 48 VDC, APS5	
<i>Photo Not Available</i>	*THSN6300KC2	Auxiliary Power Supply, Group, 24 VDC	THSN9782709
	THSN6300MK1	Auxiliary Sensor Card, Tape Selector, Hi	
	THSN6300MK2	Auxiliary Sensor Card, Tape Selector, LON	
<i>Photo Not Available</i>	DOVR6300LG1	Bus Voltage Indicator	
	THSN6300MB1	Car Wiring Interface Distributed, LON	
<i>Photo Not Available</i>	THSN6300MA1	Car Wiring Interface, Central Non-LON	THSN6300MA2
	THSN6300MA2	Car Wiring Interface, Central Non-LON	
	THSN6300NP1	Controller Inspection Run Assembly	

© 2010, Otis Elevator Company (rev. November 2010)





PC BOARDS

©2010, Otis Elevator Company (rev. November 2010)

Image	Part Number	Description	Alt/Sub/Sup P/N
	THSN6300JL2	Controller Wiring Interface	
<i>Photo Not Available</i>	THSN6300KY8	CPU (188E), Single Car w/ 2 LON Ch.	DOVR9782564
	DOVR9782564	CPU (188E)	
	DOVR6300JC2	CPU Card, 16 MHz	
	THSN6300MG1	Cross-Connect Interface, Distributed	





OTIS

Thyssen-Krupp TAC 20 (continued)

Image	Part Number	Description	Alt/Sub/Sup P/N
	THSN6300LE1	Door Bypass Board	
<i>Photo Not Available</i>	DOVR6300PM1	Door Communication Filter Board	
	THSN2783465	Drive Board	
<i>Photo Not Available</i>	DOVR6300FX4	Door Board	DOVR9832875
<i>Photo Not Available</i>	DOVR6300PY1	Door Operator Board	DOVR9832875
	DOVR9832875	Door Operator Board	
	THSN9782874	HCID (Hoistway Cable Interface Disp.) Board	
<i>Photo Not Available</i>	THSN6300MF1	Hoistway Cable Interface Distributed	
<i>Photo Not Available</i>	THSN6300MC1	Hoistway Cable, Interface C., Non-LON	THSN9782886
	THSN9782886	Hoistway Cable, Interface C., Non-LON	
<i>Photo Not Available</i>	THSN6300RE2	IOA Board	



© 2010, Otis Elevator Company (rev. November 2010)

PC BOARDS

Image	Part Number	Description	Alt/Sub/Sup P/N
	THSN6300RE3	IOA Board	
<i>Photo Not Available</i>	THSN6300LM1	I/O Controller Board, LON Node, 24 V	AAA26800AMW1
	THSN6300LL1	I/O Expansion Card, LON 24 V	AAA26800AMW1
	THSN6300LL2	I/O Expansion Card, LON 24 V	AAA26800AMW1 THSN9782916
	DOVR9782916	I/O Expansion Card, LON 24 V	THSN9782916
	THSN6300JH2	I/O Expansion Card, Non-LON, 115 VAC	

OTIS

Thyssen-Krupp TAC 20 (continued)

Image	Part Number	Description	Alt/Sub/Sup P/N
	THSN6300JH3	I/O Expansion Card, Non-LON, 230 VAC	
	THSN6300JG1	I/O Expansion Card, Non-LON, 24 VDC	
	THSN6300JH1	I/O Expansion Card, Non-LON, 24/48 V	

© 2010, Otis Elevator Company (rev. November 2010)

PC BOARDS

©2010, Otis Elevator Company (rev. November 2010)

Image	Part Number	Description	Alt/Sub/Sup P/N
	DOVR6300PN1	Interface Board	
	AAA26800AMW1	LON I/O Controller	
	AAA26800AMV1	LON I/O Extender	
	THSN6300KX1	LON Position Indicator Display, 5 x 7	
	THSN6300KW1	LON Position Indicator, 16 Segment, # 4	
	THSN6300NR1	LON Repeater Board	





OTIS

Thyssen-Krupp TAC 20 (continued)

Image	Part Number	Description	Alt/Sub/Sup P/N
	DOVR9782552	Main Processor Board	
	DOVR9782576	Main Processor Board	
	THSN9782904	Position Indicator, 5x7 LED	
	AAA621AT4	Power Supply, 24 VDC, 50 Watts, APS1	
<i>Photo Not Available</i>	THSN6300HE1	Power Supply, Switching, 80/120 HP Board	THSN9848101
<i>Photo Not Available</i>	THSN9848101	Power Supply, Switching, 80/120 HP Board	
	THSN6300RD3	Processor Board	





© 2010, Otis Elevator Company (rev. November 2010)

PC BOARDS

Image	Part Number	Description	Alt/Sub/Sup P/N
	THSN6300NC1	Relay Rectifier	
<i>Photo Not Available</i>	DOVR6300PE1	Service Tool, Owner	
<i>Photo Not Available</i>	THSN6300MJ3	Tape Reader, High Resolution	
	THSN9782849	Tape Reader, Low Resolution	
	THSN9782898	TC1D, Board	
<i>Photo Not Available</i>	THSN6300MD1	Traveling Cable Interface Distributed	THSN9782898
<i>Photo Not Available</i>	THSN6300ME1	Traveling Cable, Interface C., Non-LON	THSN9782862
	THSN9782862	Traveling Cable, Interface C., Non-LON	





OTIS

TAC 50, TAC 50-04

Image	Part Number	Description	Alt/Sub/Sup P/N
	THSN6300VF1	186C Board, TAC 50-04	
<i>Photo Not Available</i>	DOVR9816410	AC/DC Current Regulator Board	
<i>Photo Not Available</i>	DOVR9846410	AC/DC Current Regulator Board, TAC 50-04	
	THSN9755597	AC/DC Regenerative Control Board	
<i>Photo Not Available</i>	THSN6300GC3	AC/DC Regenerative Control Board, TAC 50-04	THSN9755597
	THSN9782709	Auxiliary Power Supply Board	
<i>Photo Not Available</i>	DOVR9816100	Backplane	
	THSN6300NJ1	Battery Charger Board, TAC 50-04	

PC BOARDS

©2010, Otis Elevator Company (rev. November 2010)

Image	Part Number	Description	Alt/Sub/Sup P/N
	DOVR6300LV1	Brake Current Regulator Board	
<i>Photo Not Available</i>	DOVR6300LV2	Brake Current Regulator Board	
	THSN6300NE2	Brake Regulator 2407BC Board, TAC 50-04.	
<i>Photo Not Available</i>	THSN9755329	Bus Voltage Indicator Board, TAC 50-04	
<i>Photo Not Available</i>	THSN6300VV1	CAN Node Board, TAC 50-04	
	DOVR9816094	Car/Group Mother Board	
	DOVR9734612	Card Reg	
	THSN6300VG1	CLW Board, TAC 50-04	

OTIS

Thyssen-Krupp TAC 50, TAC 50-04 (continued)

Image	Part Number	Description	Alt/Sub/Sup P/N
	THSN6300NP1	Controller Inspection Run Assembly	
	DOVR9843991	CPU Card 16 MHz, TAC 50	
<i>Photo Not Available</i>	DOVR6300JC3	CPU Card, 16 MHz	DOVR9843991
	DOVR9782564	CPU, 188E Board	
	DOVR9816975	Current Regulator Board, TAC 50-04	
<i>Photo Not Available</i>	DOVR9816628	Current Sensor Board, 200 A, 30 Hp, TAC 50-04	
<i>Photo Not Available</i>	DOVR9816872	Current Sensor Board, 50 A, TAC 50-04	

© 2010, Otis Elevator Company (rev. November 2010)





PC BOARDS

©2010, Otis Elevator Company (rev. November 2010)

Image	Part Number	Description	Alt/Sub/Sup P/N
	THSN6300HL1	Display/Interface Board, TAC 50-04 & UDB	
	DOVR9832875	Door Operator Board, TAC 50-04	
<p><i>Photo Not Available</i></p>	DOVR6300GE2	Door Operator Board, Dover	DOVR9871822
<p><i>Photo Not Available</i></p>	DOVR6300GE4	Door Operator Board, Dover	DOVR9871822
	DOVR9871822	Door Operator Board, Dover	
	DOVR9731817	DSP Board	
	DOVR9839720	Emergency Light Board, Dover, 120 VAC, TAC 50-04	
<p><i>Photo Not Available</i></p>	THSN6300VR1	Hall Node	

OTIS

Thyssen-Krupp TAC 50, TAC 50-04 (continued)

Image	Part Number	Description	Alt/Sub/Sup P/N
	DOVR9781146	Hall Node	
	THSN6300TX2	I/O Board	
<i>Photo Not Available</i>	THSN9782916	I/O Expansion Card, LON 24 V	
<i>Photo Not Available</i>	DOVR6300HC2	Inverter Board, 80/120 HP, TAC 50-04	DOVR9816446
<i>Photo Not Available</i>	THSN6300HC3	Interface 80/120/160 HP Board, TAC 50-04	
<i>Photo Not Available</i>	THSN9816446	Interface 80/120/160 Hp Board, TAC 50-04	DOVR9816446
<i>Photo Not Available</i>	DOVR9816458	Invert Snubber, 80/120 Hp Board	
<i>Photo Not Available</i>	DOVR9816689	Inverter Interface, 3/00 Rev (6 Pack), TAC 50-04	
<i>Photo Not Available</i>	DOVR9816380	Inverter Interface	
	DOVR9816446	Inverter, 80/120 Hp, Board	
	THSN6300VH1	IOC Board, TAC 50-04	

© 2010, Otis Elevator Company (rev. November 2010)



PC BOARDS

©2010, Otis Elevator Company (rev. November 2010)

Image	Part Number	Description	Alt/Sub/Sup P/N
	THSN6300NR1	LON Repeater Board	
	DOVR9863000	PMI 48 I/O Board	
<i>Photo Not Available</i>	DOVR9719234	POS Encoder Reg	
	THSN9782801	Position Indicator Controller, LON	
<i>Photo Not Available</i>	DOVR9816124	PS2 Power Supply Board	
	DOVR9816392	QSR Board	
<i>Photo Not Available</i>	THSN9816471	QSS/QSR Interface 80/120/160 Hp Board, TAC 50-04	
<i>Photo Not Available</i>	THSN9816483	QSS/QSR, Snubber Board, TAC 50-04	
<i>Photo Not Available</i>	DOVR9734715	Regulator Board, High Armature Voltage, >361 V	
<i>Photo Not Available</i>	DOVR6300PE1	Service Tool, Owner	
<i>Photo Not Available</i>	THSN6300HD4	Snubber 80/120/160 HP Board, TAC 50-04	

OTIS

Thyssen-Krupp TAC 50, TAC 50-04 (continued)

Image	Part Number	Description	Alt/Sub/Sup P/N
	THSN9816460	Snubber 80/120/160 Hp Board, TAC50-04	
<p><i>Photo Not Available</i></p>	DOVR9755470	Snubber Board	
<p><i>Photo Not Available</i></p>	THSN9848101	Switching Power Supply 80/120 Hp Board	
	THSN9803490	Universal Door Controller Board	

© 2010, Otis Elevator Company (rev. November 2010)

US Elevator

Ascension 1000

Image	Part Number	Description
<i>Photo Not Available</i>	USEL146-05600-300	Buss Board
<i>Photo Not Available</i>	USEL146-05610-300	Personality Board
<i>Photo Not Available</i>	USEL146-05635-300	Car Call Board
<i>Photo Not Available</i>	USEL146-05650-300	Motion Board



OTIS

MP-1200, MP-1210, MP-1220

Image	Part Number	Description	Alt/Sub/Sup P/N	Application
<i>Photo Not Available</i>	USEL146-05151-302	2-Speed & Pattern Control Board		MP-1220
<i>Photo Not Available</i>	USEL145-05228-300	48-Level Security Board		MP-1230
<i>Photo Not Available</i>	USEL146-05020-300	A1 Drive Intf.	USEL146-05021-300	MP-1230
	USEL146-05021-300	A1 Drive Intf.		MP-1230
	USEL146-05212-300	A1 Sup. Rel.		MP-1200/ MP-1210TM
<i>Photo Not Available</i>	USEL145-05010-300	A2 Computer	USEL146-05010-300	MP-1230
<i>Photo Not Available</i>	*USEL146-05220-300	A2 Computer Board	USEL146-05221-300	MP-1220
	USEL146-05010-300	A2 Computer Board	USEL146-05011-300	MP-1230
	USEL146-05011-300	A2 Computer Board		MP-1230
	USEL146-05221-300	A2 Computer Board		MP-1220
<i>Photo Not Available</i>	USEL148-05003-300	A3 Gen Field Control		MP-1200/ MP-1210TM
<i>Photo Not Available</i>	USEL148-05003-300C	A3 Gen Field Control	USEL148-05003-300	MP-1200/ MP-1210TM
<i>Photo Not Available</i>	USEL146-05235-300	A3 Inspection & Test Board		MP-1200/ MP-1210TM





© 2010, Otis Elevator Company (rev. November 2010)

PC BOARDS

Image	Part Number	Description	Alt/Sub/Sup P/N	Application
<i>Photo Not Available</i>	USEL146-05030-300	A3 Option Board		MP-1230
	USEL146-05230-300	A3, A4, A5 Board		MP-1220
<i>Photo Not Available</i>	*USEL146-05230-200	A3, A4, A5 Input/Output	USEL146-05230-300	MP-1220
<i>Photo Not Available</i>	USEL148-05005-200	A5 Brake/Motor Field		MP-1200/ MP-1210TM
<i>Photo Not Available</i>	USEL145-05134-300	Call Storage		MP-1200/ MP-1210TM, MP-1220, MP-1230
<i>Photo Not Available</i>	USEL146-05040-300	Cartop Control Board		MP-1230
<i>Photo Not Available</i>	USEL146-05280-300	Cartop Control Board		MP-1220
<i>Photo Not Available</i>	USEL146-05281-300	Cartop Control Board		MP-1220
<i>Photo Not Available</i>	USEL440-00040-007	Diode Board TEX IV		
<i>Photo Not Available</i>	USEL145-05104-300	Door Operator		MP-1200/ MP-1210TM, MP-1220, MP-1230
<i>Photo Not Available</i>	USEL145-05104-300A	Door Operator Board	USEL145-05104-300	MP-1200/ MP-1210TM, MP-1220, MP-1230
<i>Photo Not Available</i>	*USEL153-05007-300	Earthquake Detector Board		
<i>Photo Not Available</i>	USEL146-05001-300	Gong Board		MP-1220
<i>Photo Not Available</i>	USEL146-05001-300	Gong Board		MP-1220, MP-1230
<i>Photo Not Available</i>	USEL145-05178-300	Gong Board, 1 Up 2 Down		MP-1220
	USEL146-05286-300	I/O Board, Input Buffer		MP-1220

OTIS

US Elevator MP-1200, MP-1210, MP-1220 (continued)

Image	Part Number	Description	Alt/Sub/Sup P/N	Application
	USEL146-05287-300	I/O Board, Output Latch		MP-1220
<i>Photo Not Available</i>	USEL148-05004-300	Interface Drive Unit		MP-1200/ MP-1210TM
<i>Photo Not Available</i>	USEL146-05246-300	MOM/MOH Door Board		MP-1220
	USEL146-05200-300	Mother Board		MP-1220
	USEL146-05300-300	Mother Board		MP-1230
	USEL146-05285-300	Multiplex Transceiver Board		MP-1220
<i>Photo Not Available</i>	USEL146-05080-300	Personality Board		MP-1230, MP-1220
	USEL146-05290-300	Personality Board		MP-1220
<i>Photo Not Available</i>	USEL145-05103-300D	Power Distribution Board		MP-1230
<i>Photo Not Available</i>	USEL146-05071-300	Power Relay Board		MP-1230
<i>Photo Not Available</i>	USEL146-05263-300	Power Relay Board		MP-1200/ MP-1210TM

© 2010, Otis Elevator Company (rev. November 2010)



PC BOARDS

Image	Part Number	Description	Alt/Sub/Sup P/N	Application
<i>Photo Not Available</i>	USEL146-05260-300	Power Relay Mother-board		MP-1220
	USEL146-05060-300	Power Supply		MP-1220, MP-1230
<i>Photo Not Available</i>	USEL146-05090-300	Power Supply		MP-1220, MP-1230
<i>Photo Not Available</i>	USEL145-05200-300	Rectifier Door Board.		RELAY SOL- ID STATE
<i>Photo Not Available</i>	USEL145-05169-300	Relay CPU Board		MP-1200/ MP-1210TM
<i>Photo Not Available</i>	USEL145-05179-300	SSD-1 Drive Interface		MP-1200/ MP-1210TM
<i>Photo Not Available</i>	USEL148-05029-300C	SSD1 Interface Board		MP-1230
<i>Photo Not Available</i>	USEL149-00001-001	Varitron SS-D1 Board	WRLD.7000.9012	MP-1200, MP-1210, RELAY SOL- ID STATE
<i>Photo Not Available</i>	USEL145-05226-300	Z1 Regulator Board		MP-1200/ MP-1210TM

OTIS

Westinghouse

DMR

Image	Part Number	Description	Alt/Sub/Sup P/N	Application
<i>Photo Not Available</i>	WEST196C596G01	MGD		DMR MD1A, Motor Drive
<i>Photo Not Available</i>	WEST196C596H01	MGD		DMR MD1A, Motor Drive
	WEST196C595G01	MPS Power Supply		DMR MD1A, Motor Drive
<i>Photo Not Available</i>	*WEST195C503G02	MT3	WEST998C275H11	DMR MD1A
<i>Photo Not Available</i>	WEST998C275H11	MT3 Dual Timers		
<i>Photo Not Available</i>	*WEST195C503G03	MT3 Dual Timers	WEST998C275H11	DMR MD1A
	WEST195C503G01	MT3 Dual Timers	WEST998C275H11	DMR MD1A
<i>Photo Not Available</i>	WEST196C584G01	SP1		DMR MD1A, Motor Drive
<i>Photo Not Available</i>	WEST195C503H01	Timer	WEST998C275H11	DMR MD1A

© 2010, Otis Elevator Company (rev. November 2010)





PC BOARDS

Door Operator

Image	Part Number	Description	Alt/Sub/Sup P/N
<i>Photo Not Available</i>	*WEST998C147H12	DCB	WEST998C147H15
	WEST998C147H15	DCB	

OTIS



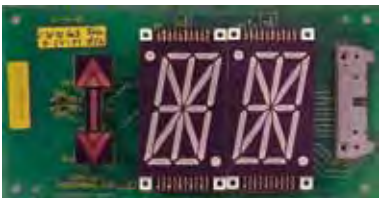

Epoch

Image	Part Number	Description	Alt/Sub/Sup P/N	Application
<i>Photo Not Available</i>	WEST2633C12G03	Car Top Sensor		Epoch I
	WEST998C199H12	DCI	WEST998C199H13	Epoch II VA / Miconic A
<i>Photo Not Available</i>	WEST998C199H13	DCI		Epoch II VA / Miconic A
<i>Photo Not Available</i>	*WEST998C076H11	DDD	WEST998C076H14	Epoch I
<i>Photo Not Available</i>	*WEST998C076H13	DDD	WEST998C076H14	Epoch I
	WEST998C076H12	DDD	WEST998C076H13	Epoch I
	WEST998C076H14	DDD		Epoch I
	WEST998C164H12	DPB		Epoch II, MPH II
	WEST998C169H11	DPR		Epoch, MPH

© 2010, Otis Elevator Company (rev. November 2010)

PC BOARDS

©2010, Otis Elevator Company (rev. November 2010)

Image	Part Number	Description	Alt/Sub/Sup P/N	Application
<i>Photo Not Available</i>	WEST998C224H11	ENC		Epoch II VA / Miconic A ACVF
<i>Photo Not Available</i>	WEST998C083H11	EPA		Epoch I
<i>Photo Not Available</i>	WEST998C089H11	EPB		Epoch I
<i>Photo Not Available</i>	WEST998C206H11	ETS		Epoch II VA Miconic A
	WEST998C212H11	FCM		Epoch II, MPH II
<i>Photo Not Available</i>	WEST998C214H25	High Voltage PCB		SCHD224213
<i>Photo Not Available</i>	WEST998C123H11	HPI		Epoch
	WEST998C214H11	HVM	WEST998C214H12	Epoch II, MPH II
<i>Photo Not Available</i>	WEST998C214H12	HVM	WEST998C214H25	Epoch II, MPH II
<i>Photo Not Available</i>	WEST998C227H12	INT		Epoch II VA / Miconic A ACVF
<i>Photo Not Available</i>	*WEST998C090H11	IO2	WEST998C090H12	Epoch I
<i>Photo Not Available</i>	WEST998C090H12	IO2		Epoch I
	WEST998C091H11	IO6	WEST998C091H12	Epoch I
<i>Photo Not Available</i>	WEST998C091H12	IO6		Epoch I
	WEST998C092H11	IO8	WEST998C092H12	Epoch I

OTIS



Westinghouse Epoch (continued)

Image	Part Number	Description	Alt/Sub/Sup P/N	Application
	WEST998C092H12	IO8		Epoch I
<i>Photo Not Available</i>	*WEST998C102H14	IOT	WEST998C102H12	Epoch I
	WEST998C102H11	IOT	WEST998C102H12	Epoch I
<i>Photo Not Available</i>	WEST998C102H12	IOT		Epoch I
<i>Photo Not Available</i>	WEST998C231H11	LWI		Epoch II
<i>Photo Not Available</i>	WEST998C131H11	Memory Board, 16K X 8		Epoch
	WEST998C030H27	MFR		Epoch I MD 4, MD6 Drives
	WEST998C080H14	MGA	WEST998C080H15	Epoch I

© 2010, Otis Elevator Company (rev. November 2010)

PC BOARDS

©2010, Otis Elevator Company (rev. November 2010)

Image	Part Number	Description	Alt/Sub/Sup P/N	Application
	WEST998C080H15	MGA		Epoch I
<i>Photo Not Available</i>	*WEST998C080H11	MGA Geared	WEST998C080H14	Epoch I
<i>Photo Not Available</i>	*WEST998C080H12	MGA Geared	WEST998C080H14	Epoch I
<i>Photo Not Available</i>	*WEST998C080H13	MGA Geared	WEST998C080H14	Epoch I
<i>Photo Not Available</i>	WEST998C080H13	MGA Geared		Epoch I
<i>Photo Not Available</i>	*WEST998C142H12	MGA Gearless	WEST998C142H13	Epoch
<i>Photo Not Available</i>	*WEST998C142H13	MGA Gearless	WEST998C142H14	Epoch
<i>Photo Not Available</i>	WEST998C142H14	MGA Gearless		Epoch
<i>Photo Not Available</i>	*WEST998C142H11	MGA Gearless Board	WEST998C142H12 WEST998C142H14	Epoch
	WEST998C255H14	MGC		Epoch II
<i>Photo Not Available</i>	*WEST998C002H11	MGI	WEST998C002H12	Epoch I
<i>Photo Not Available</i>	*WEST998C002H12	MGI	WEST998C002H14	Epoch I
<i>Photo Not Available</i>	*WEST998C140H13	MGI		Epoch
<i>Photo Not Available</i>	WEST998C002H14	MGI		Epoch I
	WEST998C254H12	MGS		Epoch II, Miconic VA
<i>Photo Not Available</i>	WEST998C153H13	MPT	WEST998C153H14 WEST998C153H15	Epoch II
<i>Photo Not Available</i>	WEST998C153H14	MPT	WEST998C153H15	Epoch II

OTIS



Westinghouse Epoch (continued)

Image	Part Number	Description	Alt/Sub/Sup P/N	Application
<i>Photo Not Available</i>	WEST998C153H15	MPT		Epoch II
	WEST998C215H11	MST	WEST998C231H11	Epoch II
<i>Photo Not Available</i>	*WEST998C197H11	MTV	WEST998C197H12	Epoch II VA Miconic A
<i>Photo Not Available</i>	WEST998C197H12	MTV	WEST998C197H13	Epoch II, Miconic VA
<i>Photo Not Available</i>	WEST998C197H13	MTV	SCHD225723	Epoch II VA Miconic A
	WEST998C026H26	MVR		Epoch I, MD 4, MD 6 Drives
	WEST998C257H11	PTC		Epoch II
	WEST998C256H12	PTS		Epoch II

© 2010, Otis Elevator Company (rev. November 2010)



PC BOARDS

©2010, Otis Elevator Company (rev. November 2010)

Image	Part Number	Description	Alt/Sub/Sup P/N	Application
	WEST6919C50G01	RAM Module, REM Board 8k Add-On for SBCc		Epoch I
<i>Photo Not Available</i>	WEST998C288H11	RDI	WEST998C288H12	Epoch II VA / Miconic A SSDC
<i>Photo Not Available</i>	WEST998C288H12	RDI		Epoch II VA / Miconic A SSDC
<i>Photo Not Available</i>	*WEST998C088H11	REX	WEST998C088H12	Epoch I
<i>Photo Not Available</i>	*WEST998C088H12	REX		Epoch I
<i>Photo Not Available</i>	WEST6916C24G01	SBC		Epoch I
<i>Photo Not Available</i>	WEST6916C24G02	SBC		Epoch I
<i>Photo Not Available</i>	WEST6916C24G03	SBC		Epoch I
<i>Photo Not Available</i>	WEST6916C24G04	SBC		Epoch I
<i>Photo Not Available</i>	WEST6916C24G05	SBC		Epoch I
	WEST6916C23G04	SBC-U		Epoch I
	WEST6916C23G03	SBC-U Assem- bly, for Dis- patcher Car 1-4 Slot U		Epoch I
<i>Photo Not Available</i>	*WEST6916C23G06	SBC-W		Epoch I
<i>Photo Not Available</i>	*WEST6916C23G07	SBC-W		Epoch I

OTIS

Westinghouse Epoch (continued)

Image	Part Number	Description	Alt/Sub/Sup P/N	Application
	WEST6916C23G05	SBC-W		Epoch I
	WEST6916C23G01	SBC-W Board Assembly, for Car Slot W		Epoch I
	WEST6916C23G02	SBC-W Board Assembly, for Car Slot W, Last Car		Epoch I
<i>Photo Not Available</i>	WEST6916C25G01	SBX-351	SCHD224371	Epoch I
	WEST6916C25G03	SBX-351 Board, for Group to Cars 1-4	SCHD225054	Epoch I
	WEST6916C25G02	SBX-351 Board, for Last Car	SCHD225053	Epoch I

© 2010, Otis Elevator Company (rev. November 2010)

PC BOARDS

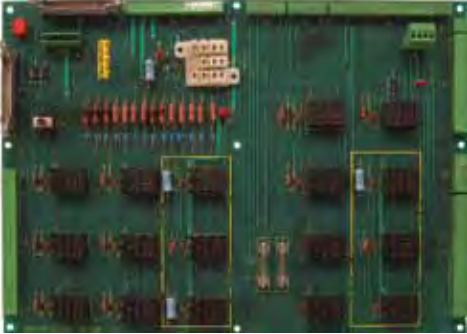
Image	Part Number	Description	Alt/Sub/Sup P/N	Application
<i>Photo Not Available</i>	*WEST6916C25G04	SCM, SBX-351		Epoch I
<i>Photo Not Available</i>	WEST6916C25G05	SCM, SBX-351		Epoch I
<i>Photo Not Available</i>	WEST998C112H11	TB2		Epoch
<i>Photo Not Available</i>	WEST998C113H11	TB3		Epoch I
<i>Photo Not Available</i>	WEST998C115H11	TB5		Epoch
	WEST998C276H22	TCP		Epoch II Car Station
<i>Photo Not Available</i>	*WEST999C003H25	TRM	WEST999C003H26	Epoch II
	WEST999C003H11	TRM	WEST999C003H12 WEST999C003H24 WEST999C003H26 WEST999C003H25	Epoch II
<i>Photo Not Available</i>	WEST999C003H12	TRM	WEST999C003H26 WEST999C003H24 WEST999C003H25	Epoch II
<i>Photo Not Available</i>	WEST999C003H24	TRM	WEST999C003H25 WEST999C003H26	Epoch II
<i>Photo Not Available</i>	WEST999C003H26	TRM		Epoch II

OTIS

ER8, ER9, ERL

Image	Part Number	Description	Alt/Sub/Sup P/N	Application
<i>Photo Not Available e</i>	*WEST196C628H01	ER Amplifier Board	WEST998C110H12	ERL
<i>Photo Not Available</i>	WEST477C977H03	ER8/ER9 Amplifier	WEST998C108H12	ERL
<i>Photo Not Available</i>	WEST477C843H03	ERL Amplifier Board	WEST477C977H03	ERL
<i>Photo Not Available</i>	WEST998C110H11	ERB Amplifier	WEST998C110H12	ERL
<i>Photo Not Available</i>	WEST998C110H12	ERB Amplifier		ERL

Fixtures

Image	Part Number	Description
	WEST999C996H33	L15 Car Panel PI Display Unit
<i>Photo Not Available</i>	WEST998C280H11	MTA, for MTA Button Fixture

PC BOARDS

Motor Drive (MD-1A)

Image	Part Number	Description	Alt/Sub/Sup P/N
	WEST998C033H22	MCI	
<i>Photo Not Available</i>	WEST999C203H23	MSA (TRN)	
<i>Photo Not Available</i>	WEST999C204H12	MSB	
<i>Photo Not Available</i>	WEST998C077H24	PM1	
<i>Photo Not Available</i>	*WEST196C584H01	SP1	WEST196C584G01
<i>Photo Not Available</i>	WEST196C584G01	SP1	
<i>Photo Not Available</i>	WEST998C000H66	SPJ	

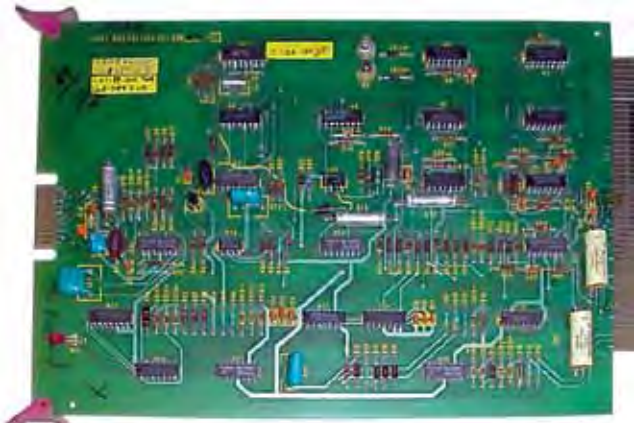

OTIS

Motrol

Image	Part Number	Description	Alt/Sub/Sup P/N
	WEST998C204H12	DTS	
<i>Photo Not Available</i>	*WEST998C208H11	EPG	
<i>Photo Not Available</i>	*WEST998C209H15	IBP	
<i>Photo Not Available</i>	WEST998C053H12	MBF	
<i>Photo Not Available</i>	WEST998C050H23	MIB	
<i>Photo Not Available</i>	WEST998C073H12	MPB	
<i>Photo Not Available</i>	*WEST998C205H15	MS1	
<i>Photo Not Available</i>	WEST998C032H15	MS1	
<i>Photo Not Available</i>	WEST998C205H11	MS1	WEST998C205H15
<i>Photo Not Available</i>	WEST998C061H14	MS2	
	WEST998C064H12	MS3	



PC BOARDS

©2010, Otis Elevator Company (rev. November 2010)

Image	Part Number	Description	Alt/Sub/Sup P/N
	WEST998C064H13	MS3	
<i>Photo Not Available</i>	WEST998C126H17	MS5	
<i>Photo Not Available</i>	WEST998C127H14	MS6	
<i>Photo Not Available</i>	WEST998C171H13	MS7	
<i>Photo Not Available</i>	WEST998C184H12	MS8	
<i>Photo Not Available</i>	WEST998C071H13	MSC	
<i>Photo Not Available</i>	WEST998C172H12	MSM	
	WEST998C054H23	MSN	
<i>Photo Not Available</i>	WEST999C225H25	MSR	
<i>Photo Not Available</i>	WEST998C122H12	TPG	

OTIS



Mark IV, Mark V

Image	Part Number	Description	Alt/Sub/Sup P/N	Application
	WEST998C013H24	Board		Mark V
<i>Photo Not Available</i>	WEST1185C14H01	D01 Car Controller Board		Mark V
<i>Photo Not Available</i>	WEST1185C15H01	D02 Car Controller Board	WEST998C013H35	Mark V
<i>Photo Not Available</i>	WEST998C013H35	D02 Car Controller Board		Mark V
<i>Photo Not Available</i>	WEST1185C03H01	D11 (TRN)		Mark V
	WEST998C010H33	DI3		Mark V
<i>Photo Not Available</i>	*WEST998C011H11	DN1	WEST998C011H12	Mark V
<i>Photo Not Available</i>	*WEST998C011H12	DN1	WEST998C011H23	Mark V
<i>Photo Not Available</i>	WEST998C011H23	DN1		Mark V
<i>Photo Not Available</i>	*WEST1185C11H01	DN1 Corridor Cage Board	WEST998C011H11	Mark V
<i>Photo Not Available</i>	*WEST998C012H11	DN2	WEST998C012H12	Mark V
<i>Photo Not Available</i>	*WEST998C012H12	DN2	WEST998C012H13	Mark V
<i>Photo Not Available</i>	*WEST998C012H13	DN2	WEST998C012H16	Mark V
<i>Photo Not Available</i>	*WEST998C012H16	DN2	WEST998C012H26 WEST998C012H27	Mark V

© 2010, Otis Elevator Company (rev. November 2010)





PC BOARDS

©2010, Otis Elevator Company (rev. November 2010)

Image	Part Number	Description	Alt/Sub/Sup P/N	Application
	WEST998C012H26	DN2	WEST998C012H27	Mark V
<i>Photo Not Available</i>	WEST998C012H27	DN2		Mark V
<i>Photo Not Available</i>	*WEST1185C12H01	DN2 Corridor Cage Board	WEST998C012H11	Mark V
<i>Photo Not Available</i>	*WEST998C015H11	DN3	WEST998C015H21	Mark V
<i>Photo Not Available</i>	*WEST998C015H21	DN3	WEST998C015H22	Mark V
<i>Photo Not Available</i>	*WEST998C015H22	DN3	WEST998C015H23	Mark V
<i>Photo Not Available</i>	*WEST998C015H23	DN3	WEST998C015H33	Mark V
<i>Photo Not Available</i>	WEST998C015H33	DN3		Mark V
<i>Photo Not Available</i>	WEST1185C23H01	DN3 Car Controller Board	WEST998C015H22	Mark V
<i>Photo Not Available</i>	*WEST1185C13H01	DN3 Corridor Cage Board	WEST1185C23H01	Mark V
<i>Photo Not Available</i>	*WEST1185C13H02	DN3 Corridor Cage Board	WEST998C015H23	Mark V
	WEST998C014H12	DO1		Mark V
<i>Photo Not Available</i>	WEST998C014H13	DO1		Mark V
<i>Photo Not Available</i>	WEST998C013H36	DO2		Mark V
<i>Photo Not Available</i>	*WEST998C016H33	DS1	WEST998C003H11	Mark V
<i>Photo Not Available</i>	WEST998C003H11	DS1	WEST998C003H12	Mark V
<i>Photo Not Available</i>	WEST998C016H12	DS1		Mark V
<i>Photo Not Available</i>	WEST998C017H13	DS2		Mark V
<i>Photo Not Available</i>	WEST998C018H12	DS3		Mark V
<i>Photo Not Available</i>	WEST998C019H13	DS4		Mark V
<i>Photo Not Available</i>	WEST1185C20H01	DT1		Mark V
<i>Photo Not Available</i>	WEST1185C21H01	DT2		Mark V
<i>Photo Not Available</i>	WEST1185C22H01	DT3		Mark V

OTIS





Westinghouse Mark IV, Mark V (continued)

Image	Part Number	Description	Alt/Sub/Sup P/N	Application
<i>Photo Not Available</i>	WEST1185C24H01	DT6		Mark V
<i>Photo Not Available</i>	WEST998C119H11	EQ1		Mark V
<i>Photo Not Available</i>	*WEST1185C27-A	FS1		Mark V
<i>Photo Not Available</i>	*WEST998C027H11	FS1	WEST998C027H12	Mark V
<i>Photo Not Available</i>	*WEST998C027H12	FS1	WEST998C027H22	Mark V
<i>Photo Not Available</i>	*WEST998C027H22	FS1	WEST998C027H23	Mark V
	WEST998C027H23	FS1	WEST1185C27-A	Mark V
	WEST998C027H34	FS1		Mark V
<i>Photo Not Available</i>	WEST998C028H14	FS2	WEST998C072H13	Mark V
	WEST998C072H12	FS2		Mark V
<i>Photo Not Available</i>	WEST998C072H13	FS2		Mark V
	WEST998C029H22	FS3		Mark V
<i>Photo Not Available</i>	*WEST998C068H11	IEE	WEST998C068H12	Mark V

© 2010, Otis Elevator Company (rev. November 2010)

PC BOARDS

©2010, Otis Elevator Company (rev. November 2010)

Image	Part Number	Description	Alt/Sub/Sup P/N	Application
<i>Photo Not Available</i>	*WEST998C068H12	IEE		Mark V
	WEST1185C30H01	IT1		Mark V
<i>Photo Not Available</i>	*WEST1185C31H01	IT2	WEST998C031H01	Mark V
<i>Photo Not Available</i>	*WEST998C031H01	IT2	WEST998C031H11	Mark V
	WEST998C031H11	IT2	WEST1185C31H01	Mark V
	WEST1185C32H01	IT3		Mark V
<i>Photo Not Available</i>	*WEST1185C33H01	MC1		Mark V
	WEST998C034H28	MO1		Mark V
<i>Photo Not Available</i>	WEST998C086H11	OVA Assembly		Mark V

OTIS

Westinghouse Mark IV, Mark V (continued)

Image	Part Number	Description	Alt/Sub/Sup P/N	Application
	WEST998C035H23	PD1		Mark V
<i>Photo Not Available</i>	WEST998C036H23	PD2	WEST998C279H13	Mark V
<i>Photo Not Available</i>	WEST998C279H12	PD2	WEST998C279H13	Mark V
<i>Photo Not Available</i>	WEST998C279H13	PD2		Mark V
<i>Photo Not Available</i>	WEST998C037H11	PD3	WEST998C279H12	Mark V
<i>Photo Not Available</i>	WEST1185C38H01	PD4		Mark V
<i>Photo Not Available</i>	WEST998C039H12	PD5		Mark V
<i>Photo Not Available</i>	WEST998C040H21	PD6		Mark V
<i>Photo Not Available</i>	WEST998C041H12	PD7		Mark V
<i>Photo Not Available</i>	*WEST1185C42H01	PE1	WEST998C042H11	Mark V
	WEST998C042H11	PE1		Mark V
<i>Photo Not Available</i>	*WEST1185C43H01	PE2	WEST1185C43H02	Mark V
<i>Photo Not Available</i>	*WEST1185C43H02	PE2	WEST1185C43H03	Mark V
	WEST1185C43H03	PE2	WEST2633C12G03	Mark V

© 2010, Otis Elevator Company (rev. November 2010)





PC BOARDS

©2010, Otis Elevator Company (rev. November 2010)

Image	Part Number	Description	Alt/Sub/Sup P/N	Application
	WEST1185C43H04	PE2		Mark V
<i>Photo Not Available</i>	WEST998C098H37	PE3		Mark V
	WEST998C043H12	PE4		Mark V
<i>Photo Not Available</i>	WEST998C044H55	PE4		Mark V
<i>Photo Not Available</i>	WEST998C084H12	PE4		Mark V
<i>Photo Not Available</i>	WEST998C079H12	PE5		Mark V
	WEST998C099H11	PE5		Mark V
<i>Photo Not Available</i>	WEST998C099H12	PE5		Mark V
<i>Photo Not Available</i>	WEST382D282G01	Power Supply, DC, +5 V, +15 V, -15 V		Mark V
<i>Photo Not Available</i>	WEST382D282G02	Power Supply, DC, +5 V, +15 V, -15 V		Mark V
<i>Photo Not Available</i>	*WEST1185C45H01	PR1	WEST998C045H12	Mark V/Epoch I
<i>Photo Not Available</i>	*WEST998C045H11	PR1	WEST998C045H12	Mark V
<i>Photo Not Available</i>	*WEST998C045H12	PR1	WEST998C045H22	Mark V
	WEST998C045H22	PR1		Mark V

OTIS

Westinghouse Mark IV, Mark V (continued)

Image	Part Number	Description	Alt/Sub/Sup P/N	Application
<i>Photo Not Available</i>	WEST998C049H12	RG2		Mark V
<i>Photo Not Available</i>	WEST998C046H13	RG4		Mark V
<i>Photo Not Available</i>	WEST998C047H23	RG5		Mark V
<i>Photo Not Available</i>	WEST998C048H23	RG6		Mark V
<i>Photo Not Available</i>	*WEST998C052H23	SM2		Mark V
<i>Photo Not Available</i>	*WEST196C597H01	SMF2 Design PC	WEST196C597G01	Mark IV Selectomatic
	WEST196C597G01	SMF2 Design PC		Mark IV Selectomatic
<i>Photo Not Available</i>	WEST998C058H21	SP3		Mark V
<i>Photo Not Available</i>	WEST998C059H27	SP4		Mark V
	WEST998C060H66	SP5		Mark V
	WEST998C078H13	SP6		Mark V
	WEST998C057H11	SP7		Mark V



© 2010, Otis Elevator Company (rev. November 2010)

PC BOARDS

Image	Part Number	Description	Alt/Sub/Sup P/N	Application
<i>Photo Not Available</i>	WEST998C056H13	SP8		Mark V
<i>Photo Not Available</i>	WEST998C075H11	SP8		Mark V
<i>Photo Not Available</i>	*WEST195501H01	Timer		Mark V
<i>Photo Not Available</i>	WEST998C062H46	TM1		Mark V
<i>Photo Not Available</i>	*WEST1185C63H01	TM2	WEST998C063H11	Mark V
<i>Photo Not Available</i>	*WEST998C063H11	TM2	WEST998C063H12	Mark V
<i>Photo Not Available</i>	*WEST998C063H12	TM2	WEST998C063H13	Mark V
<i>Photo Not Available</i>	*WEST998C063H13	TM2	WEST998C063H23	Mark V
	WEST998C063H23	TM2		Mark V
<i>Photo Not Available</i>	WEST998C063H24	TM2		Mark V
<i>Photo Not Available</i>	*WEST1185C64H01	TM3		Mark V
<i>Photo Not Available</i>	WEST998C065H11	TMJ		Mark V
<i>Photo Not Available</i>	WEST998C003H12	TRM	WEST998C003H26	Mark V
<i>Photo Not Available</i>	WEST998C003H26	TRM		Mark V
<i>Photo Not Available</i>	WEST998C070H22	TTL		Mark V

OTIS

Motor Drive

Image	Part Number	Description
	WEST196C587H01	Phase Lock Oscillator "Older Version"
<p><i>Photo Not Available</i></p>	WEST998C009H11	PLO
<p><i>Photo Not Available</i></p>	WEST196C585G01	SP2
	WEST196C585H01	SP2

© 2010, Otis Elevator Company (rev. November 2010)

PC BOARDS

MPH

Image	Part Number	Description	Alt/Sub/Sup P/N	Application
<i>Photo Not Available</i>	*WEST998C198H13	DPI	WEST998C198H14	MPH II
<i>Photo Not Available</i>	*WEST998C198H14	DPI		MPH II
<i>Photo Not Available</i>	WEST998C198H11	DPI		MPH II
	WEST998C198H12	DPI	WEST998C198H13	MPH II
<i>Photo Not Available</i>	WEST998C150H11	ECB		MPH I
<i>Photo Not Available</i>	*WEST998C148H11	FCB	WEST998C148H12 SCHD225094	MPH I and II
<i>Photo Not Available</i>	*WEST998C148H12	FCB	SCHD225094 WEST998C148H13	MPH I and II
<i>Photo Not Available</i>	*WEST998C148H13	FCB	SCHD225094	MPH I and II
<i>Photo Not Available</i>	WEST998C148H14	FCB	SCHD225094	MPH I and II
	WEST998C148H15	FCB	SCHD225094	MPH I and II
	WEST998C148H25	FCB	SCHD225094 WEST998C148H26	MPH I and II
	WEST998C148H26	FCB	SCHD225094	MPH I and II

OTIS





Westinghouse MPH (continued)

Image	Part Number	Description	Alt/Sub/Sup P/N	Application
	WEST998C177H11	HR2		MPH
<i>Photo Not Available</i>	*WEST998C146H11	HRM	WEST998C146H22	MPH I
<i>Photo Not Available</i>	*WEST998C146H21	HRM	WEST998C146H22	MPH I
	WEST998C146H22	HRM		MPH I
<i>Photo Not Available</i>	*WEST998C214H25	HVM	SCHD224213	MPH II, Miconic A
	WEST998C188H11	IOX	SCHD224213	MPH II, Miconic A
<i>Photo Not Available</i>	*WEST998C187H11	MHC	WEST998C187H24 WEST998C187H12	MPH II
<i>Photo Not Available</i>	*WEST998C187H14	MHC	WEST998C187H24	MPH II

© 2010, Otis Elevator Company (rev. November 2010)



PC BOARDS

©2010, Otis Elevator Company (rev. November 2010)

Image	Part Number	Description	Alt/Sub/Sup P/N	Application
	WEST998C187H12	MHC	WEST998C187H13 WEST998C187H14 WEST998C187H25 WEST998C187H24	MPH II
	WEST998C187H13	MHC	WEST998C187H25 WEST998C187H24 WEST998C187H14	MPH II
	WEST998C187H24	MHC	WEST998C187H25	MPH II
<i>Photo Not Available</i>	WEST998C187H25	MHC	WEST998C187H26	MPH II
	WEST998C187H26	MHC	SCHD225515	MPH II
<i>Photo Not Available</i>	*WEST998C145H11	MPH	WEST998C145H22	MPH I
<i>Photo Not Available</i>	*WEST998C145H22	MPH	WEST998C145H23	MPH I
<i>Photo Not Available</i>	*WEST998C145H23	MPH	WEST998C145H24	MPH I
<i>Photo Not Available</i>	*WEST998C145H25	MPH	WEST998C145H24	MPH I

OTIS

Westinghouse MPH (continued)

Image	Part Number	Description	Alt/Sub/Sup P/N	Application
	WEST998C145H24	MPH		MPH I
<i>Photo Not Available</i>	WEST998C173H21	NSP	WEST998C173H22	MPH
	WEST998C173H22	NSP		MPH
<i>Photo Not Available</i>	*WEST998C189H12	RMH	WEST998C189H13	MPH II
<i>Photo Not Available</i>	*WEST998C189H13	RMH	WEST998C189H14	MPH II
<i>Photo Not Available</i>	*WEST998C189H14	RMH	WEST998C216H28	MPH II
<i>Photo Not Available</i>	*WEST998C216H13	RMH	WEST998C216H14 WEST998C216H15 WEST998C216H26 WEST998C216H27 WEST998C216H28	MPH II
<i>Photo Not Available</i>	*WEST998C216H14	RMH	WEST998C216H15 WEST998C216H26 WEST998C216H27 WEST998C216H28	MPH II
<i>Photo Not Available</i>	WEST998C216H12	RMH	WEST998C216H13 WEST998C216H14 WEST998C216H15 WEST998C216H26 WEST998C216H27 WEST998C216H28	MPH II
<i>Photo Not Available</i>	WEST998C216H15	RMH	WEST998C216H26 WEST998C216H27 WEST998C216H28	MPH II
<i>Photo Not Available</i>	WEST998C216H26	RMH	WEST998C216H27 WEST998C216H28	MPH II
<i>Photo Not Available</i>	WEST998C216H27	RMH	WEST998C216H26 WEST998C216H28	MPH II
<i>Photo Not Available</i>	WEST998C216H28	RMH		MPH II
<i>Photo Not Available</i>	*WEST998C190H12	RMH CSA		MPH II
<i>Photo Not Available</i>	WEST998C222H15	RMH CSA		MPH II

© 2010, Otis Elevator Company (rev. November 2010)

PC BOARDS

QKS Operator

Image	Part Number	Description	Alt/Sub/Sup P/N
<i>Photo Not Available</i>	*WEST7267C08G01	TDC	WEST999C001H25
<i>Photo Not Available</i>	*WEST998C308H11	TDC	WEST999C001H36
<i>Photo Not Available</i>	*WEST999C001H11	TDC	WEST999C001H12 WEST999C001H23 WEST999C001H24 WEST999C001H25 WEST999C001H31 WEST999C001H36
<i>Photo Not Available</i>	*WEST999C001H23	TDC	WEST999C001H24 WEST999C001H25
<i>Photo Not Available</i>	*WEST999C001H31	TDC	SCHD223825 WEST999C001H36
<i>Photo Not Available</i>	WEST999C001H12	TDC	WEST999C001H23 WEST999C001H24 WEST999C001H25 WEST999C001H31 WEST999C001H36
<i>Photo Not Available</i>	WEST999C001H24	TDC	WEST999C001H25 WEST999C001H36
<i>Photo Not Available</i>	WEST999C001H25	TDC	WEST999C001H31 WEST999C001H36



WEST999C001H36 TDC SCHD223825

OTIS

Relay

Image	Part Number	Description	Alt/Sub/Sup P/N
<i>Photo Not Available</i>	*WEST477C977H02	Amplifier Board	WEST998C110H12
<i>Photo Not Available</i>	WEST998C118H11	ASM	
<i>Photo Not Available</i>	*WEST5196D35H	ER10 Amplifier	WEST998C110H11
<i>Photo Not Available</i>	WEST103D976G01	ER9 Model Electronic Regulator	WEST1718C08G01
<i>Photo Not Available</i>	WEST1718C08G01	ER11 ERL Regulator Assy.	
<i>Photo Not Available</i>	*WEST998C108H11	ERA Amp	WEST998C108H12
<i>Photo Not Available</i>	*WEST998C109H11	ERA Amp	
<i>Photo Not Available</i>	WEST998C108H12	ERA Amp	
<i>Photo Not Available</i>	WEST998C087H11	OVA Assembly	
<i>Photo Not Available</i>	*WEST478C315	Timer	WEST478C315G01
<i>Photo Not Available</i>	WEST478C315G01	Timer Y-Delta 5 Min	

PC BOARDS

Miscellaneous

Image	Part Number	Description	Alt/Sub/Sup P/N
<i>Photo Not Available</i>	WEST195C500H01	1 Min Timer	
<i>Photo Not Available</i>	WEST998C117H11	BBI	
<i>Photo Not Available</i>	WEST998C120H11	DMM Dead Man Timer Module	
<i>Photo Not Available</i>	WEST195C502G01	MG Timer	
<i>Photo Not Available</i>	WEST998C279H12	PD2B	WEST998C279H13
<i>Photo Not Available</i>	WEST998C279H13	PD2B	
<i>Photo Not Available</i>	*WEST382D281G01	Power Supply, 125 V	

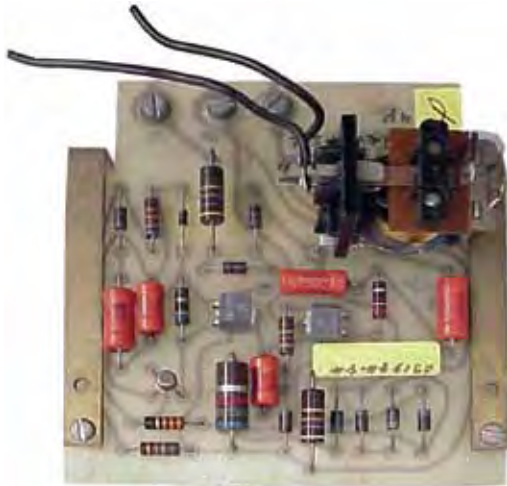

WEST195C252G01 PRD

<i>Photo Not Available</i>	WEST195C252H01	PRD	SCHD8544C48H01
<i>Photo Not Available</i>	SCHD8544C48H01	PRD, Phase Protector	
<i>Photo Not Available</i>	WEST998C096H22	Real-Time Clock Board	
<i>Photo Not Available</i>	*WEST105C501	Timer	
<i>Photo Not Available</i>	*WEST195C502	Timer	
<i>Photo Not Available</i>	*WEST195C503	Timer	WEST195C503H01
<i>Photo Not Available</i>	WEST195C501H01	Timer	
<i>Photo Not Available</i>	*WEST999C422H11	WCF, World Class	

OTIS

World Elevator

Image	Part Number	Description	Alt/Sub/Sup P/N
<i>Photo Not Available</i>	*WRLD7101.9031	1 Phase Rectifier Assembly	DOVR9879810
<i>Photo Not Available</i>	*WRLD7101.9032	3 Phase Rectifier Assembly	DOVR9879675
<i>Photo Not Available</i>	*WRLD7601.9009	AC Output w/TB	MTGMP-16776
<i>Photo Not Available</i>	*WRLD7601.9010	AC Output, w/Molex	MTGMP-16777
<i>Photo Not Available</i>	*WRLD7103.9009	Auxiliary Sensor, for DMC-I	DOVR9741331
<i>Photo Not Available</i>	*WRLD7101.9006	Car Board, 4-Slot, Dover	DOVR9855221
<i>Photo Not Available</i>	*WRLD7103.9016	CLC Processor, New Style	DOVR9715710
<i>Photo Not Available</i>	*WRLD7000.9019	Counter Board	
<i>Photo Not Available</i>	*WRLD7602.9005	CPU Board, for Miprom 21	MTGMP-24377
<i>Photo Not Available</i>	WRLD7000.9007	Digital Display, 7-Segment	
<i>Photo Not Available</i>	*WRLD7101.9033	Digital PI Card, 7-Segment, Dover	DOVR9713335
<i>Photo Not Available</i>	WRLD7000.9003	Diode Array, World Replacement for Amtech	
<i>Photo Not Available</i>	*WRLD7101.0004	Door 4 Slot	DOVR124519
<i>Photo Not Available</i>	*WRLD7101.9004	Door 4 Slot	DOVR9855233
<i>Photo Not Available</i>	WRLD7000.9002	Door Operator Control, Amtech	
<i>Photo Not Available</i>	*WRLD7101.9044	Double / Single Phase Rectifier	DOVR113065
<i>Photo Not Available</i>	*WRLD7000.9034	Dual Timer Board, Omega 1000	
<i>Photo Not Available</i>	*WRLD7101.9013	Duplex 3-Slot Board, Dover	DOVR9884336
<i>Photo Not Available</i>	*WRLD7202.9002	ER10 Amp	WEST998C110H12
<i>Photo Not Available</i>	*WRLD7202.9001	ER9 Amp	WEST998C108H12
<i>Photo Not Available</i>	*WRLD7401.9004	EVC Leveling Switch	
<i>Photo Not Available</i>	*WRLD7103.9002	HD-85 Door Operator	DOVR9804134
<i>Photo Not Available</i>	*WRLD7103.9017	HD-85 Door Operator Board, for DMC-I	DOVR6300FX2
<i>Photo Not Available</i>	*WRLD7103.9012	I/O Expansion Board, for DMC-I	DOVR9841453
<i>Photo Not Available</i>	*WRLD7206.9012	I/O X Board, Westinghouse	WEST998C188H11
<i>Photo Not Available</i>	*WRLD7601.9007	Input Board w/Tb	MTGMP-16785
<i>Photo Not Available</i>	*WRLD7601.9015	Input Board w/Tb	MTGMP-24151
<i>Photo Not Available</i>	*WRLD7601.9008	Input w/Molex	MTGMP-16778
<i>Photo Not Available</i>	*WRLD7101.9030	Interface Board	

© 2010, Otis Elevator Company (rev. November 2010)

PC BOARDS

©2010, Otis Elevator Company (rev. November 2010)

Image	Part Number	Description	Alt/Sub/Sup P/N
<i>Photo Not Available</i>	WRLD7000.9030	Interface Board	
<i>Photo Not Available</i>	*WRLD7103.9011	Interface Box, for Freedom Tool	WRLD7502.9027
<i>Photo Not Available</i>	*WRLD7101.9010	Intermediate 4 Slot Board, Dover	DOVR9855269
<i>Photo Not Available</i>	WRLD7000.9004	Level Sensor Decoder	
<i>Photo Not Available</i>	*WRLD7401.0004	Leveling Switch Decoder	HGTN76693
<i>Photo Not Available</i>	*WRLD7101.9015	Logic 3 Slot Board, Dover	DOVR68180
<i>Photo Not Available</i>	*WRLD7101.9048	LSP Printed Board	DOVR9813949
<i>Photo Not Available</i>	*WRLD7103.9008	Main Sensor, for DMC-I	DOVR9841325
<i>Photo Not Available</i>	*WRLD7105.9009	Main Sensor, for Dover T-III	DOVR9853686
<i>Photo Not Available</i>	*WRLD7206.9009	MHC Processor	WEST998C187H24
<i>Photo Not Available</i>	*WRLD7601.9018	Mini-Monitor Diagnostic Tool, Montgomery	AAA27BT26
<i>Photo Not Available</i>	*WRLD7412.9005	MIO Processor Board	WEST998C246H12
<i>Photo Not Available</i>	WRLD7603.9008	MLS Door Operator Board	
<i>Photo Not Available</i>	*WRLD7603.1008	MLS Door Operator Board, for Miprom 21	MTGMP-24150
<i>Photo Not Available</i>	*WRLD7603.9004	Motherboard	MTGMP-15766
<i>Photo Not Available</i>	WRLD7403.9009	Motherboard, 120 V	
<i>Photo Not Available</i>	*WRLD7602.9002	Motherboard, for Miprom 21	MTGMP-24288
<i>Photo Not Available</i>	*WRLD7603.9003	Motor Power Board, MAC	MTGMP-24172
<i>Photo Not Available</i>	*WRLD7206.9002	MPH Processor	WEST998C145H24
<i>Photo Not Available</i>	*WRLD7104.9007	MSC-I Power Board	DOVR9880665



*WRLD7104.9008	MSC-I Regulator	DOVR9840497
----------------	-----------------	-------------

<i>Photo Not Available</i>	*WRLD7602.9004	MSU Board, for Miprom 21	MTGMP-24972
----------------------------	----------------	--------------------------	-------------

OTIS

World Elevator (continued)

Image	Part Number	Description	Alt/Sub/Sup P/N
	*WRLD7101.9023	Optical Leveling Card	DOVR9811266
<i>Photo Not Available</i>	*WRLD7101.9012	Option 4 Slot Board, Dover	DOVR9753217
<i>Photo Not Available</i>	*WRLD7601.9014	Output Board w/Tb	MTGMP-24147
<i>Photo Not Available</i>	*WRLD7602.9006	P I/O Board, for Miprom 21	MTGMP-24301
<i>Photo Not Available</i>	*WRLD7000.9010	PI Display, 7-Segment, Double Digit Display	
<i>Photo Not Available</i>	*WRLD7101.9024	PI Driver Power Board	DOVR9811370
<i>Photo Not Available</i>	*WRLD7601.1013	PI, Dig, #3, w/EPROM, Service	MTGMP-24869-003
<i>Photo Not Available</i>	*WRLD7101.9002	Power 4 Slot Board, Dover	DOVR9855245
<i>Photo Not Available</i>	*WRLD7103.9007	Power Supply, 5/12 VDC. For DMC-I.	DOVR9841507
<i>Photo Not Available</i>	*WRLD7103.9001	Power Unit Relay Board	DOVR9841301
<i>Photo Not Available</i>	*WRLD7602.9007	PROM Board, for Miprom 21	MTGMP-24298
<i>Photo Not Available</i>	*WRLD7101.9039	Rectifier Board	DOVR9715289
<i>Photo Not Available</i>	*WRLD7101.9035	Rectifier, 3-Phase, Universal	
<i>Photo Not Available</i>	*WRLD7601.9011	Relay Output Board	MTGMP-24100
<i>Photo Not Available</i>	WRLD7000.9011	Reverse-Phase Module	
<i>Photo Not Available</i>	*WRLD7101.9025	Reverse-Phase Relay Board, for Dover	DOVR9781870
<i>Photo Not Available</i>	*WRLD7206.9003	RHM Relay Board	WEST998C216H15
<i>Photo Not Available</i>	*WRLD7412.9006	RHM Relay Board	WEST998C216H27
<i>Photo Not Available</i>	*WRLD7105.9008	Sel. I/O Assembly, for Dover T-III	DOVR9853728
<i>Photo Not Available</i>	*WRLD7101.9043	Selector Leveling Board	DOVR9885213
<i>Photo Not Available</i>	*WRLD7103.9004	Selector Processor Board, for DMC-I	DOVR9841313
<i>Photo Not Available</i>	*WRLD7603.9002	Speed Control Board, MAC	MTGMP-24561

© 2010, Otis Elevator Company (rev. November 2010)

PC BOARDS

Image	Part Number	Description	Alt/Sub/Sup P/N
<i>Photo Not Available</i>	*WRLD7000.9005	Speed Limiting Safety Board	
<i>Photo Not Available</i>	WRLD7000.9001	Stepper Board, Amtech	
<i>Photo Not Available</i>	*WRLD7104.9003	System Monitor Board, for MSC-I	DOVR9840515
<i>Photo Not Available</i>	*WRLD-7501-0042	Top Board on GFC-IIA Assembly	WRLD.7000.9012
<i>Photo Not Available</i>	*WRLD-7501-0043	Top Board on GFC-IIA Assembly	WRLD.7000.9012
<i>Photo Not Available</i>	*WRLD7101.9008	Top/Bottom Board, 4KY	DOVR9855257
<i>Photo Not Available</i>	*WRLD7109.9507	Universal Timer, 0.1-260 Sec.	DOVR9815296
<i>Photo Not Available</i>	WRLD.7000.9012	Varitron / SSD1	

OTIS

PC BOARDS

©2010, Otis Elevator Company (rev. November 2010)

North America: (800) 600 - 6847 • Fax (860) 286 - 1605
Elsewhere: (860) 286-4573 • lynn.molinaroli@otis.com

OTIS