



# Catalog of Parts

for the

# Thyssen TAC 20 & TAC 50

Available from OSC

# 800-600-6847

Revised: September 2013





NOTE: Please refer to OtisWave for the latest revision of this catalog.

## TABLE OF CONTENTS



<i>Controller Parts—TAC 20.....</i>	<i>3</i>
<i>Controller Parts—TAC 50.....</i>	<i>11</i>
<i>Controller Parts—TAC 50.....</i>	<i>13</i>
<i>Door Operators &amp; Related.....</i>	<i>17</i>
<i>Fixtures .....</i>	<i>23</i>
<i>Machines, Motors, Governor, Encoder &amp; Valves.....</i>	<i>31</i>
<i>Machines, Motors, Governor, Encoder &amp; Valves.....</i>	<i>32</i>
<i>Machines, Motors, Governor, Encoder &amp; Valves.....</i>	<i>36</i>
<i>PC Boards .....</i>	<i>37</i>
<i>PC Boards .....</i>	<i>47</i>
<i>Position Indicator Equipment .....</i>	<i>62</i>
<i>Power Supply / Batteries .....</i>	<i>63</i>
<i>Service Tool.....</i>	<i>67</i>

**NOTE:** Many of the parts listings within this catalog include a system type. Please note that the part may apply to other systems as well.



## CONTROLLER PARTS—TAC 20

<i>NOTE: Illustrations NOT to scale.</i>	Otis Part No.	OEM Part No.	OEM Print No.	Part Description	Symbol	Volts
	DOVR9882777	9882777 PMB-24	177AC1	Buzzer, 24 V	BUZ1	
	COMMCA7-PA-01	9853121	297AC1	Contact, Auxiliary, 1P, 1 NC		
	AAA447AD7	GMSTB2.5/8-ST 8313B/8		Connector, Female, 8 position, 7.5 mm Pin Distance		
	DOVR298AG2	42EF35AF	298AG2	Contact, 3-Pole	MC1	120 VAC Coil





## CONTROLLER PARTS—TAC 20

<i>NOTE: Illustrations NOT to scale.</i>	Otis Part No.	OEM Part No.	OEM Print No.	Part Description	Symbol	Volts
<i>Photo Not Available</i>	FURN42GE35AF106	42GE35AF106		Contactors, 3-Pole	MC1	120 VAC Coil
	DOVR9853110	9853110	298AA1	Contactors, 4-Pole NO, w/Overload Relay, 120 VAC, 24 A		120 VAC Coil
	AAA375BM2	MCR-1/8 251.125		Fuse, Pico 1/8 Amp		125
<i>Photo Not Available</i>	AAA375BM3	MCR-1/4 251.250		Fuse, Pico 1/4 Amp		125
<i>Photo Not Available</i>	AAA375BM4	MCR-3/8 251.375		Fuse, Pico 3/8 Amp		125
<i>Photo Not Available</i>	AAA375BM5	MCR-1/2 251.500		Fuse, Pico 1/2 Amp		125
<i>Photo Not Available</i>	AAA375BM6	MCR-3/4 251.750		Fuse, Pico 3/4 Amp		125
<i>Photo Not Available</i>	AAA375BM7	MCR-1 251001		Fuse, Pico 1 Amp		125



## CONTROLLER PARTS—TAC 20

<i>NOTE: Illustrations NOT to scale.</i>	Otis Part No.	OEM Part No.	OEM Print No.	Part Description	Symbol	Volts
<i>Photo Not Available</i>	AAA375BM8	MCR-11/2 25101.5		Fuse, Pico 1.5 Amps		125
<i>Photo Not Available</i>	AAA375BM9	MCR-2 251002		Fuse, Pico 2 Amps		125
<i>Photo Not Available</i>	AAA375BM10	MCR-21/2 25102.5		Fuse, Pico 2.5 Amps		125
	AAA375BM11	MCR-3 251003		Fuse, Pico 3 Amps		125
<i>Photo Not Available</i>	AAA375BJ23	FNQ-3 AMP		Fuse, Slo-Blo, 3 amps		500
<i>Photo Not Available</i>	AAA375BK39	FNQ-R 10 AMP		Fuse, Slo-Blo, 10 amps		500
	COMM50.12.9.024.100			Relay, Board Mounted, 2 Form C (DPDT). Used in place of 44.52.9.024.5000.	K1-12	24 VDC"Coil
<i>(similar to COMM50.12.9.024.100)</i>	COMM50.12.9.110.1000			Relay, Board Mounted, DPDT		100 VDC
<i>(similar to COMM814-0727)</i>	COMMRJ2V-C-A120	RJ2V-C-A120		Relay, Board Mounted, DPDT		120 AC

## CONTROLLER PARTS—TAC 20

<i>NOTE: Illustrations NOT to scale.</i>	Otis Part No.	OEM Part No.	OEM Print No.	Part Description	Symbol	Volts
	COMM32.21.7.024.2300	32.21.7.024.2300		Relay, Board Mounted, 1 NO SPST	K1–K8	24 VDC Coil
	AAA00613AAC009	CS4C-22Z-110D 3RH1122-1BF40		Relay, Control, 4-Pole, 2 NO, 2 NC Contacts	GL	110 VDC Coil
	AAA613CX506	3RH1122-1AK60		Relay, General Purpose, 2 NO, 2 NC Contacts		120 VAC Coil
	COMM40.52.8.120.5000	40.52.8.120.5000		Relay, Mini, Finder, Power, 2 Form C (DPDT).	MUTS	120 VAC Coil

## CONTROLLER PARTS—TAC 20

<i>NOTE: Illustrations NOT to scale.</i>	Otis Part No.	OEM Part No.	OEM Print No.	Part Description	Symbol	Volts
	COMMRT424615	41.52.8.115.0000 RT424615		Relay, Mini, Schrack, Power, 2 Form C (DPDT)	MUTS	115 VAC
	COMM095.91.3	095.91.3		Retaining Clip, Plastic, Finder. Used with socket 95.85.		
	COMM95.85.3	95.85.3		Socket, Relay, Finder		

## CONTROLLER PARTS—TAC 20

*NOTE: Illustrations NOT to scale.*

Otis  
Part No.

OEM  
Part No.

OEM  
Print No.

Part Description

Symbol

Volts



DOVR9739040

9739040  
AC53a 6-6 30-80

787AF3

Starter,  
AC Semiconductor  
Motor, 3-Phase, 50/60  
Hz

200 /  
230 /  
460 VAC



THSN799AM1

799AM1

Strainer, Intake, Small



THSN799AM2



799AM2

Strainer, Intake, Large



## CONTROLLER PARTS—TAC 20





*NOTE: Illustrations NOT to scale.*

	Otis Part No.	OEM Part No.	OEM Print No.	Part Description	Symbol	Volts
	COMM99.80.0.230.09.0	99.80.0.230.09.0		Suppression Device, Contactor, RC Circuit	MUTS	110– 240 Nominal Voltage
	COMM99.80.3.000.00.0	99.80.3.000.00.0		Suppression Device, Diode 6	TSLX	6–220 Nominal Voltage
	THSNTAC20KIT			TAC 20 First Day Kit Consists of: <ul style="list-style-type: none"> <li>• 4 Static Caps (COMMDCC-03)</li> <li>• TAC 20 Battery (THSN116AH1)</li> <li>• 11 24-VDC Relays (COMM814-0727)</li> <li>• 3 120-V Relays (COMM40.52.8.120.5000)</li> <li>• 2 Adhesive Disk Holders</li> <li>• Key (DOVR9703135)</li> <li>• Key (DOVR9731064)</li> <li>• Key (DOVR9703196)</li> <li>• Disk (640A2)</li> <li>• Battery (MT-128002-4)</li> </ul>		

## CONTROLLER PARTS—TAC 20

<i>NOTE: Illustrations NOT to scale.</i>	Otis Part No.	OEM Part No.	OEM Print No.	Part Description	Symbol	Volts
	COMMMT0250A	MT0250A		Transformer, Control Power. 250 VA Primary Volts 240 x 480, 230 x 460, 220 x 440, 50/60 Hz. Secondary Volts 120/115/110		
	THSN9742852	9742852	874DL2	Transformer, Power, 1-Phase. Primary Volts 208 Secondary Volts 120 0.15 KVA	XFRM1	208 V
	DOVR9742840	9742840	874DL1	Transformer, Power, 1-Phase, 60 Hz, 0.15 KVA	XFRM1	
	THSN874DJ1		874DJ1	Transformer, Power, 1-Phase, 60 Hz, 0.15 KVA	XFRM1	

## CONTROLLER PARTS—TAC 50

<i>NOTE: Illustrations NOT to scale.</i>	Otis Part No.	OEM Part No.	OEM Print No.	Part Description	Symbol	Volts
<i>Photo Not Available</i>	DOVR9850229	9850229	220ED1	Cable, Communication For TAC 50-03		
<i>Photo Not Available</i>	DOVR238BT1		238BT1	Capacitor, 3600 microfarads		450 VDC
	DOVR9822136	9822136	132138	Card, Header Shunt		
 <i>COMMCA7-PA-01 Shown</i>	COMMCA7-PA-01	9853121	297AC1	Contact, Auxiliary, 1P, 1 NC		
	COMMCS7-PV-22	9853133	397AD1	Contact, Auxiliary, 2 NO, N NC		
	DOVR9853110	9853110	298AA1	Contact, Auxiliary, 4-Pole NO, w/Overload Relay, 120 VAC, 24 A		120 VAC Coil
	DOVR9724370	9724370	112386	Diode, 3 A		1000 V





## CONTROLLER PARTS—TAC 50

<i>NOTE: Illustrations NOT to scale.</i>	Otis Part No.	OEM Part No.	OEM Print No.	Part Description	Symbol	Volts
<i>Photo Not Available</i>	DOVR9816550	9816550	344BV1	Diode Module, 3-Phase Bridge, 100 A, 15 HP		800 V
<i>Photo Not Available</i>	DOVR9816173	9816173	378AH1	Fan, Flange-Type For 120 HP Drive Only		
<i>Photo Not Available</i>	DOVR9816185	9816185	799AD1	Fan, 6-inch, For 120 HP Drive Only		
	THSNTAC50KIT			First Day Kit Consists of: 1 EPROM, 32Kx8 (AAA616PD1) 1 EPROM, 64Kx8 (AAA616MB2) 1 EPROM, EPROM 27C1030-100DC (AAA616NK2), 5 labels (102LH1), 1 3.5" HD Disk (640A2), & 1 EPROM Box (102-12B- 3)		
<i>Photo Not Available</i>	AAA375BJ23	FNQ-3 AMP		Fuse, Slo-Blo, 500 Volts, 3 amps		
<i>Photo Not Available</i>	AAA375BK39	FNQ-R 10 AMP		Fuse, Slo-Blo, 500 Volts, 10 amps		



## CONTROLLER PARTS—TAC 50

<i>NOTE: Illustrations NOT to scale.</i>	Otis Part No.	OEM Part No.	OEM Print No.	Part Description	Symbol	Volts
	DOVR9816434	816434	155CD1	IGBT, Single, 600 A, 120 HP		1200 V
	DOVR9816793	9816793	155CX1	IGBT, Dual Pack, 300 A, 60 HP		1200 V
	DOVR9816732	9816732	155CP1	IGBT, Dual Pack, 600 A		600 V
	DOVR9816835	9816835	155CR1	IGBT, 6 Pack, 75A, 15 HP		1200 V
	DOVR9816690	9816690	155CK1	IGBT, 6 Pack, 100 A, 15 HP		600 V
	DOVR9816574	9816574	155CL1	IGBT, 6 Pack, 100 A, 20 HP		600 V
	DOVR9816859	9816859	155CT1	IGBT, 6 Pack, 100 A, 20 HP		1200 V
	DOVR9816677	9816677	155CM1	IGBT, 6 Pack, 100 A, 30 HP		600 V
	DOVR9816574	9816574	155CN1	IGBT, 6 Pack, 100 A, 40 HP		600 V
	DOVR9816630	9816630	155CJ1	IGBT, 6 Pack, 100 A, 7.5/10 HP		600 V
	DOVR9816860	9816860	155CV1	IGBT, 6 Pack, 150 A, 30 HP		1200 V
	DOVR9756565	9756565, PM150DSA120	155BJ1	IGBT Transistor 40 HP (150AQSS)		
<i>Photo Not Available</i>	DOVR9731301	9731301, CM50DU-24F	IGBT Transistor Lug, 50 Amp, 2X 1200 Volt			

## CONTROLLER PARTS—TAC 50

<i>NOTE: Illustrations NOT to scale.</i>	Otis Part No.	OEM Part No.	OEM Print No.	Part Description	Symbol	Volts
	P613AB12	9853522, RR3B-ULC-AC120V	690AB1	Relay, 3 PDT		120 VAC
	COMMGPS3PDTL24DC	9853534, RR2B-UL-DC24V	690AC1	Relay, 3 PDT		24 VDC
	R0613A1	RR3B-ULC-DC24V		Relay, 3 PDT		24 VDC
	AAA613CX506	3RH1122-1AK60		Relay, General Purpose, 2 NO, 2 NC Contacts		120 VAC Coil
	AAA613CX515	3RH1122-1BB40		Relay, General Purpose, 2 NO, 2 NC Contacts		24 VDC Coil
	AAA613CX505	3RH1131-1AK60		Relay, General Purpose, 3 NO, 1 NC Contacts		120 VAC Coil
<i>Photo Not Available</i>	DOVR9818019	9818019	690DA2	Relay, Reverse Phase 3-Phase Monitor		480 V
	DOVR9818546	9818546	699AV4	Resistor, 50 Ohm, 100 Watts		
<i>Photo Not Available</i>	DOVR736AK3		736AK3	Sensor Assembly, Load-Weighing		
	AAA618AF2	9853560	770AC1	Socket, Relay		
	DOVR9755615	9755615	804AV1	Suppressor, Assembly		480 V

## CONTROLLER PARTS—TAC 50

<i>NOTE: Illustrations NOT to scale.</i>	Otis Part No.	OEM Part No.	OEM Print No.	Part Description	Symbol	Volts
	DOVR9804420	9804420	804AC1	Suppressor, Transient Assembly		220 V
	AAA613CX705	3RT1916-1CD00		Suppressor, Surge Rated Operating Voltage 127 VAC to 240 VAC		127 VAC– 240 VAC
	AAA613CX704	3RT1916-1DG00		Suppressor, Surge Rated Operating Voltage 12 VDC to 250 VDC		12 VDC– 250 VDC
<i>Photo Not Available</i>	DOVR9816069	9816069	171DB3	Switch, Pushbutton Down, Grey, Controller, with Contact		
<i>Photo Not Available</i>	DOVR9816045	9816045	171DB1	Switch, Pushbutton Up, Grey, Controller, with Contact Block		
	THSN370AJ2			Transient Suppression Module, AC1. For TAC 50-04		

## CONTROLLER PARTS—TAC 50

*NOTE: Illustrations NOT to scale.*

Otis Part No.	OEM Part No.	OEM Print No.	Part Description	Symbol	Volts
------------------	-----------------	------------------	------------------	--------	-------



THSN370AJ3

Transient Suppression  
Module, P24. For TAC  
50-04



DOVR9853674

9853674



874BG1

Transformer,  
3 Phase,  
T1-3.75 KVA, 50/60 HZ



230/24  
0 VAC





## DOOR OPERATORS & RELATED

<i>NOTE: Illustrations NOT to scale.</i>	Otis Part No.	OEM Part No.	OEM Print No.	Part Description	System
<i>Photo Not Available</i>	DOVR125AD2	125AD2		Belt, For 36-in. Opening	LD-03
<i>Photo Not Available</i>	DOVR125AD3	125AD3		Belt, For 42-in. Opening	LD-03
	DOVR9711739	YET2040 12 9711739	101172	Bearing, Pillow Block	TAC 20 TAC 50
	DOVR9850922	9850922	485DE9R2	Cable, RS-232 to RS-485 Converter, Orange. For SmartTech® door operator only.	TAC 20 TAC 50
<i>Photo Not Available</i>	THSN381AM1			EMI Line Filter. Filters incoming AC power supply voltage to door operator.	
<i>See Photo of Motor DOVR9779504</i>	DOVR9861982	9861982	373AW1	Encoder For door operator motor.	TAC 50
<i>Photo Not Available</i>	DOVR9838533	63853		Door Hanger Assembly, High Pocket with Standard Upthrust	LD-03
<i>Photo Not Available</i>	DOVR461BF1	461BF1		Door Hanger Assembly, High Pocket	LD-03



## DOOR OPERATORS & RELATED

<i>NOTE: Illustrations NOT to scale.</i>	Otis Part No.	OEM Part No.	OEM Print No.	Part Description	System
<i>Photo Not Available</i>	DOVR196VF1		621973	Door Restrictor	TAC 20
	DOVR9779504	9779504	591DB2	Motor, Door Operator Assembly with Encoder	TAC 20 TAC 50
	DOVR9841775	9841775 22352100	141772	Motor, Door Operator with Optical Sensor Assy., 1/6 HP, 1140 RPM, 115 VDC, Foot Mount, Model 3330D-129  Encoder Assembly Alone, p/n DOVR9741770; Sensor, p/n DOVR610AC1	TAC 20
<i>See Photo of DOVR9841775</i>	DOVR9801704	9801704 22352100	141707	Motor, Door Operator, 1/6 HP, 1140 RPM, 115 VDC, Foot Mount, Model 3330D-129 Brush p/n BP5052P01	TAC 20

## DOOR OPERATORS & RELATED

<i>NOTE: Illustrations NOT to scale.</i>	Otis Part No.	OEM Part No.	OEM Print No.	Part Description	System
	DOVR591BJ1	9739593		Motor, Door Operator 1/2 HP, 1140 RPM, 115 VAC, 60 Hz, 3-Phase, 48Z Frame	TAC 50
<i>Photo Not Available</i>	DOVR9854058		590CD1	Motor, Door Operator, DC, 1/2 HP, 115 V, Double Shaft	TAC 50
<i>Photo Not Available</i>	DOVR9817920	590CT1		Motor, Door Operator Includes encoder and door pulley.	LD-03
<i>Photo Not Available</i>	DOVR9834526	596CP1		Mount, For proximity magnet.	LD-03S
<i>See Photo of DOVR9841775</i>	DOVR9741770	9741770	141806	Optical Sensor Assy. Used on Door Operator Motor 9801704	TAC 20
	DOVR6300FX4		6300FX4	PC Board, TAC 20 Door Operator Board (w/ 675HA1, 675EV1)	TAC 20
	DOVR6300FX6		6300FX6	PC Board, TAC 20 Door Operator Board (with 675HA2)	TAC 20



## DOOR OPERATORS & RELATED

<i>NOTE: Illustrations NOT to scale.</i>	Otis Part No.	OEM Part No.	OEM Print No.	Part Description	System
	DOVR9832875	9832875	6300PY1	PC Board, TAC 20 Door Operator Board, EDB, (same as 6300PY2 but with 675HA2 software).	TAC 20
<i>Photo Not Available</i>	DOVR9871822	9871822	6300GE4	PC Board TAC 50 Door Operator (SmartTech®) <b>(REPAIRS ONLY)</b>	TAC 50
	THSN9875847		6300ABN1	PC Board TAC 50 Door Operator (SmartTech®) Supersedes DOVR9871822.	TAC 50
<i>Photo Not Available</i>	DOVR9872681	9872681	6300GL1	PC Board, I/O Interface TAC 50 Door Operator	TAC 50
	DOVR9803490	9803490	6300PA2	PC Board, Universal Door Controller, LD-03, HD-03, HD-04 Door Operators	TAC 20



## DOOR OPERATORS & RELATED

<i>NOTE: Illustrations NOT to scale.</i>	Otis Part No.	OEM Part No.	OEM Print No.	Part Description	System
<i>Photo Not Available</i>	DOVR9803889	9803889	6300PA4	PC Board, Universal Door Controller, Use with door motor over 1/3 HP	TAC 20 TAC 50 50-03 50-04
<i>Photo Not Available</i>	DOVR9803877	9803877	6300PA3	PC Board, Universal Door Controller, Use with door motor up to 1/3 HP	TAC 20 TAC 50 50-03 50-04
<i>Photo Not Available</i>	DOVR9836408	568AN1 736BE1		Proximity Switch Kit	LD-03
<i>Photo Not Available</i>	DOVR677AE1	677AE1		Pulley	LD-03
<i>Photo Not Available</i>	DOVR677AG1	677AG1		Pulley, Idler	LD-03
	DOVR127196		127196	Pushbutton, For cartop run box.	LD-03
<i>Photo Not Available</i>	DOVR200ABX1	200ABX1		Roller Assembly Kit, For C/O and SSLH Gate Switch.	LD-03
<i>Photo Not Available</i>	DOVR200ABX2	200ABX2		Roller Assembly For SSRH Gate Switch	LD-03
<i>Photo Not Available</i>	DOVR781DA1	781DA1		Spacer, Bearing	LD-03

## DOOR OPERATORS & RELATED



<i>NOTE: Illustrations NOT to scale.</i>	Otis Part No.	OEM Part No.	OEM Print No.	Part Description	System
	DOVR9810857	9810857	108150	Stop Switch Assy., Horizontal, 1 Make, 1 Break, Red Button 1-1/4" Diameter Marked "PUSH STOP PULL RUN"	TAC 20 TAC 50
	DOVR9810985	9810985	109888	Stop Switch Assy., Horizontal, Red Button 1-1/4" Diameter Marked "PUSH INSPECTION PULL AUTO"	TAC 20 TAC 50
<i>Photo Not Available</i>	DOVR171EP1	171EP1		Switch Assembly, Gate Switch	LD-03
<i>Photo Not Available</i>	DOVR9739555	127196		Switch Button, TOC Insp., Run	LD-03
	717A19	3VX630, 9749470	77920	V-Belt, Door Operator, 63-inch Length	TAC 20 TAC 50

## FIXTURES

<i>NOTE: Illustrations NOT to scale.</i>	Otis Part No.	OEM Print No.	Part Description	Symbol
<i>Photo Not Available</i>	DOVR297BY13	297BY13	Base, Contact. LED Button Base For TAC 20.	
	DOVR128AR1	128AR1	Bezel, Grey, RF2K Series. Collar for THSN9991177. For TAC 20.	
<i>Photo Not Available</i>	DOVR9991207	128AR3	Bezel, Wine, Round, Enduro For TAC 50	
	THSN9991177		Button, Aurora For TAC 20.	

## FIXTURES



*NOTE: Illustrations NOT to scale.*

	Otis Part No.	OEM Print No.	Part Description	Symbol
	<b>DOVR9719532</b>	178AL9	<b>Jewel Assembly, Car Fire Call,</b> 24 V, Red Bezel, Red LED, Wedge Base	
	DOVR134AB1	134AB1	Base, Reflector/Switch	
	DOVR9822719	128AB3	Bezel, Red for Fire Service	
	DOVR9727152	138AD1	Holder, Lamp, Spade Connector. Used with 28 V	firefighter's hat
	DOVR9834643	2211	lamp.	
	DOVR130AB1	130AB1	Lamp, LED T1 3/4 Wedge Base	
DOVR130AF3	130AF3	Lens, Clear, 1-in. Square Face		
		Lens. For fire service.		
<i>Photo Not Available</i>	DOVR9724333	L205	Key, Hoistway Access	
<i>Photo Not Available</i>	DOVR9724345	L206	Key, Car and Hall Call Lockout	
	<b>DOVR9746195</b>	171AR21	<b>Keyswitch Assembly, In-Car Stop, Stop/Run, H1846</b> Key, 2-Position, Removable All, Vertical	
	DOVR9845641	6061AD1	Cylinder, Key. With Two H1846 Keys.	Stop Run
	DOVR9731064	103106	Key, H1846	
	DOVR9818431	171AP1	Microswitch, SPDT 250 VAC, 10 A, & 125 VDC, 0.5 A	



## FIXTURES

*NOTE: Illustrations NOT to scale.*

	Otis Part No.	OEM Print No.	Part Description	Symbol
	<b>DOVR9746020</b>	171AR3	<b>Keyswitch Assembly, Light &amp; 2-Spd Fan, H2395 Key, Removable All, Vertical</b>	Light Low Hi Off
	DOVR9719519	660AC2	Cylinder, Key. With two H2395 keys.	
	DOVR9703135	103105	Key, H2395	
	DOVR9818431	171AP1	Microswitch, SPDT, 250 VAC, 10A, & 125 VDC, 0.5 A	
	<b>DOVR9746055</b>	171AR6	<b>Keyswitch Assembly, Off/Serv./Indep., H2395 Key, 2-Position, Removable All, Vertical</b>	Off Serv. Indep
	SEESDKS-24-INDEPENDENT	128AC6	Bezel, Keyswitch Off/Serv./Indep	
	DOVR9703135	103105	Key, H2395	
	DOVR9818431	171AP1	Microswitch, SPDT, 250 VAC, 10A, & 125 VDC, 0.5 A	
	<b>DOVR9746160</b>	171AR17	<b>Keyswitch Assembly, Phase I Hall Fire Service</b>	Off On Fire Bypass
	DOVR9826191	32619	Cylinder, Restricted Key, Rotary. With two H2389 keys.	
	DOVR9703196	103107	Keys, H2389	
	DOVR9818431	171AP1	Microswitch, SPDT 250 VAC, 10 A, & 125 VDC, 0.5 A	
	DOVR131AF1	131AF1	Spacer	



## FIXTURES

*NOTE: Illustrations NOT to scale.*

	Otis Part No.	OEM Print No.	Part Description	Symbol
	DOVR9746031	171AR4	<b>Keyswitch Assembly, Phase II Car Service</b>	
	DOVR9826191	32619	Cylinder, Restricted Key, Rotary. With two H2389 keys.	Hold On
	DOVR9703196	103107	Keys, H2389	Fire
	DOVR9818431	171AP1	Microswitch, SPDT 250 VAC, 10 A, & 125 VDC, 0.5 A	Off
	DOVR131AF1	131AF1	Spacer	
	DOVR9741318	141AA2	Faceplate, Intermediate Hall Lantern, Black, Plastic	
	DOVR9832336	138AA1	Housing, Inclined	
	DOVR9730266	130AD2	Lens, Hall, 3.00 in. x 2.75 in.	Arrow (black)



## FIXTURES

*NOTE: Illustrations NOT to scale.*

	Otis Part No.	OEM Print No.	Part Description	Symbol
<i>Photo Not Available</i>	THSN6300RP1	6300RP1	PC Board Corridor Fixture Fire Hat For TAC 20	
	<b>DOVR9817190</b>	171AV1	<b>Pushbutton Assembly,</b> Non-Illuminated, Black Bezel, One Switch	
	DOVR228AF1	228AF1	Actuator. For pushbutton.	
	DOVR9822690	128AB1	Bezel, Pushbutton, Black	
	DOVR232AA1	232AA1	Housing, Microswitch. For pushbutton.	
	DOVR129BC1	129BC1	Housing, Pushbutton	
	DOVR9834643	2211	Lamp, LED T1 3/4 Wedge Base	
	DOVR9818431	171AP1	Microswitch, SPDT 250 VAC, 10 A, and 125 VDC, 0.5 A	
	DOVR9772509	770AE1	Socket, Lamp, Wedge Base. Used with T1 3/4 Lamp.	
DOVR131AF1	131AF1	Spacer		
DOVR9893209	130AA1	Target, Lens, White. For button.		
	THSN9991177	9991177	<b>Pushbutton Assembly,</b> Round, Hall Button, with White Base, 1.5 x 1.5 For TAC 20	



## FIXTURES

*NOTE: Illustrations NOT to scale.*



	Otis Part No.	OEM Print No.	Part Description	Symbol
	DOVR9798158	131AY19	Spacer, 1.25 in. wide, Handicap	*1
	DOVR9798067	131AY2	Spacer, 1.25 in. wide, Handicap	2
	DOVR9797968	131AY3	Spacer, 1.25 in. wide, Handicap	3

## FIXTURES

*NOTE: Illustrations NOT to scale.*

	Otis Part No.	OEM Print No.	Part Description	Symbol
	DOVR9797865	131AY4	Spacer, 1.25 in. wide, Handicap	4
	DOVR9796666	131AY20	Spacer, 1.25 in. wide, Handicap	B
	DOVR9797555	131AY34	Spacer, 1.25 in. wide, Handicap	Alarm (with bell symbol)



## FIXTURES

<i>NOTE: Illustrations NOT to scale.</i>	Otis Part No.	OEM Print No.	Part Description	Symbol
	D0VR9797750	131AY35	Spacer, 1.25 in. wide, Handicap	Close (with symbol)
	D0VR9797956	131AY36	Spacer, 1.25 in. wide, Handicap	Open (with symbol)
<i>Photo Not Available</i>	D0VR9816008	9816008	Switch, Rotary, 2-Position, 1 NO, 1 NC, AUTO/INSP, Front Panel TAC 50 Only	
 <i>D0VR9816033 Shown</i>	D0VR9816010	9816010	Switch, Rotary, Controller 3 NO, I/O, Front Panel TAC 50 Only	
	D0VR9816033	9816033	Switch, Rotary, Controller NC Door, Front Panel TAC 50 Only	
	D0VR9816021	9816021	Switch, Rotary, Controller NO, CPU, Front Panel TAC 50 Only	

## MACHINES, MOTORS, GOVERNOR, ENCODER & VALVES

<i>NOTE: Illustrations NOT to scale.</i>	Otis Part No.	OEM Part No.	OEM Print No.	Part Description	HP	VAC	RPM	Frame
<i>Photo Not Available</i>	COMMR-424	9847522	7502AA47	Motor, Hydraulic, Dry	40	230/ 460	3600	284T
	6333DD1	9835726	7502AB1	Motor, Submersible	15	200	3600	180
	6333DD21	9835714	7502AB11	Motor, Submersible	15	230	3600	180
	6333DD21	9835702	7502AB21	Motor, Submersible	15	460	3600	180
	DOVR9736219	9736219	7502AB2	Motor, Submersible	20	200	3600	180
	6333DD22	9785176	7502AB12	Motor, Submersible	20	230	3600	180
	6333DD9	9729975	7502AB3	Motor, Submersible	25	200	3600	180
	6333DD23	9845173	7502AB13	Motor, Submersible	25	230	3600	180
	6333DD22	9784974	7502AB22	Motor, Submersible	25	460	3600	180
	6333DD23	9845276	7502AB23	Motor, Submersible	25	460	3600	180
	6333DD13	9738514	7502AB4	Motor, Submersible	30	200	3600	180
	6333DD24	9738526	7502AB14	Motor, Submersible	30	230	3600	180
	6333DD24	9738538	7502AB24	Motor, Submersible	30	460	3600	180
	6333DD17	9838540	7502AB5	Motor, Submersible	40	200	3600	180
	6333DD25	9738551	7502AB15	Motor, Submersible	40	230	3600	180
	6333DD25	9738563	7502AB25	Motor, Submersible	40	460	3600	180

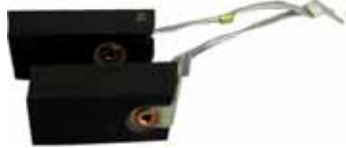
*MACHINES, MOTORS, GOVERNOR, ENCODER & VALVES*

<i>NOTE: Illustrations NOT to scale.</i>	Otis Part No.	OEM Part No.	OEM Print No.	Part Description
<i>Photo Not Available</i>	DOVR9820590	9820590	250AN1	Arm Assembly, Machine Brake, GD-1
<i>Photo Not Available</i>	DOVR142AC1		142AC1	Bearing, Cone GD-1
<i>Photo Not Available</i>	DOVR9814255	9814255	32952	Bearing, Worm, Cone Only, GD-1, 2.125 ID x 4.1250 D x 1.125 W, Tapered
	DOVR9719428	9719428		Brush, Motor, T 563, GD-1
<i>Photo Not Available</i>	DOVR9716245	9716245	309AE1	Coupling, Armature, 6.00 OD, 1.625 Shaft Dia., GD-1
<i>Photo Not Available</i>	DOVR9831723	9831723		Machine Encoder, Synergy
	DOVR9716166			Encoder, TAC 50, 5000 PPR



*MACHINES, MOTORS, GOVERNOR, ENCODER & VALVES*

*NOTE: Illustrations NOT to scale.*

Otis  
Part No.

OEM  
Part No.

OEM  
Print No.

Part Description



DOVR9716154



Encoder, TAC 50, Geared Machine Velocity,  
2048 PPR, 5 VDC





DOVR9716324

Encoder, TAC 50, Geared Machine Velocity,  
2048 PPR, Heavy Duty

## MACHINES, MOTORS, GOVERNOR, ENCODER & VALVES

<i>NOTE: Illustrations NOT to scale.</i>	Otis Part No.	OEM Part No.	OEM Print No.	Part Description
	DOVR9716178			Encoder, TAC 50, Gearless Machine Velocity, 150 RPM or less, 10K PPR
	DOVR9815740			Encoder, TAC 50, Governor Position PC Board
<i>Photo Not Available</i>	DOVR9843814	9843814	438AA2	Gland, Bearing, Output Shaft, GD-1
<i>Photo Not Available</i>	DOVR9855907	9855907	559AA1	Lining, Brake, GD-1, .25x2.25x6

*MACHINES, MOTORS, GOVERNOR, ENCODER & VALVES*

<i>NOTE: Illustrations NOT to scale.</i>	Otis Part No.	OEM Part No.	OEM Print No.	Part Description
	DOVR9732860	9732860		Repair Kit, Gasket & O-Ring for I-2 Valve
	DOVR9720911	9720911		Repair Kit, Gasket & O-Ring for I-3 Valve
	DOVR9873223	9873223	254AF1	Seal, Worm Shaft, GD-1
<p><i>Photo Not Available</i></p>	DOVR750BK2		750BK2	Sheave, Drive, GD-1





## MACHINES, MOTORS, GOVERNOR, ENCODER & VALVES

*NOTE: Illustrations NOT to scale.*



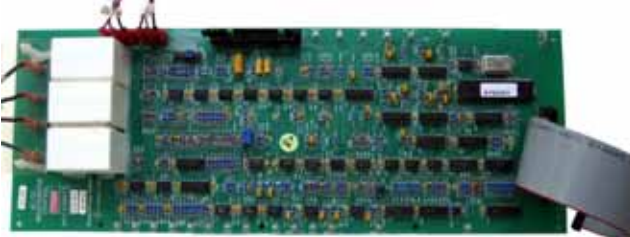

Otis Part No.	OEM Part No.	OEM Print No.	Part Description
DOVR9897227	9897227	107921	Valve, I-2, Integral, 120–215 GPM
DOVR9897215	9897215	137745	Valve, I-2, Integral, 30–100 GPM
DOVR9748325	9748325	148324	Valve, I-2, Integral
DOVR7505AE2		7505AE2	Valve, I-2, Integral
DOVR9842007	9842007		Valve, I-3, Integral

## PC BOARDS



<i>NOTE: Illustrations NOT to scale.</i>	Otis Part No.	OEM Part No.	OEM Print No.	Part Description	Voltage	Symbol	System
	AAA447X7			Connector, For PC Boards 8-Position			TAC 20
	DOVR9816410	9816410	6300LR1 6300LR3 6300LR4	PC Board, AC/DC Current Regulator			TAC 50
	THSN9755597	8755597	6300GC1, 6300GC3	PC Board, AC/DC Regenerative Control			TAC 50
	THSN6300KC3		6300KC3	PC Board, Auxiliary Power Supply	115 VAC	APS3	TAC 20

## PC BOARDS



<i>NOTE: Illustrations NOT to scale.</i>	Otis Part No.	OEM Part No.	OEM Print No.	Part Description	Voltage	Symbol	System
	THSN6300KC4		6300KC4	PC Board, Auxiliary Power Supply	150 VDC	APS4	TAC 20
	THSN6300KC5		6300KC5	PC Board, Auxiliary Power Supply	48 VDC	APS5	TAC 20
	AAA621AT4	9782680 VS50B-24	6300KC1	PC Board, Power Supply, 50 W	24 VDC	APS1	TAC 20

## PC BOARDS

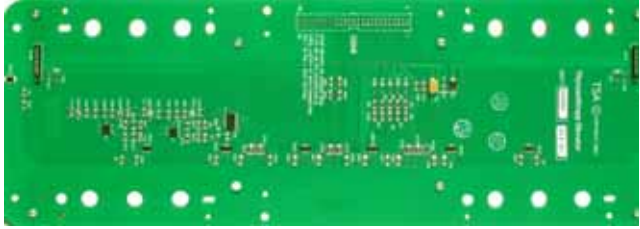
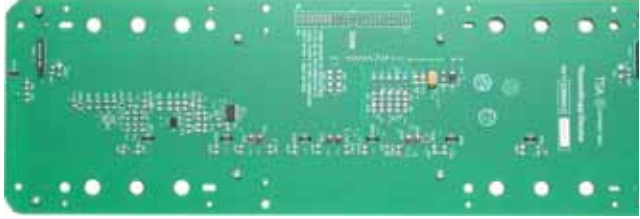
*NOTE: Illustrations NOT to scale.*



	Otis Part No.	OEM Part No.	OEM Print No.	Part Description	Voltage	Symbol	System
	THSN9782709	9782709	6300KC2	PC Board, Auxiliary Power Supply, Group	24 VDC	APS2	TAC 20
	THSN6300KC6		6300KC6	PC Board, Auxiliary Power Supply, Group	48 VDC	APS6	TAC 20
	THSN6300MK1		6300MK1	PC Board, Auxiliary Sensor, Tape Selector, High Resolution, Tape Reader		TSA	TAC 20
	THSN6300MK2		6300MK2	PC Board, Auxiliary Sensor, Tape Selector, Low Resolution, Tape Reader		TSA	TAC 20

## PC BOARDS



<i>NOTE: Illustrations NOT to scale.</i>	Otis Part No.	OEM Part No.	OEM Print No.	Part Description	Voltage	Symbol	System
<i>Photo Not Available</i>	DOVR9816100	9816100	6300CL2	PC Board, Back Plane			TAC 50
	THSN6300NJ1		6300NJ1	PC Board, Battery Charger			TAC 50-04
	DOVR6300LV1		6300LV1, 6300LV4	PC Board, Brake Current Regulator, Digital, 2 Amp			TAC 50
<i>Photo Not Available</i>	DOVR9816641	9816641	6300LV5	PC Board, Brake Current			TAC 50
<i>Photo Not Available</i>	DOVR9847005	9847005	6300NE1	PC Board, Brake Regulator			TAC 50-04
	THSN6300NE2		6300NE2	PC Board, Brake Regulator, 2047BC			TAC 50-04





*PC BOARDS*

<i>NOTE: Illustrations NOT to scale.</i>	Otis Part No.	OEM Part No.	OEM Print No.	Part Description	Voltage	Symbol	System
<i>Photo Not Available</i>	THSN9755329	9755329	6300EM2	PC Board, Bus Voltage Indicator			TAC 50
<i>Photo Not Available</i>	DOVR6300LG1	9816768	6300LG1	PC Board, Buss Voltage Indicator			TAC 50
<i>Photo Not Available</i>	THSN6300VV1	9781055	6300VV1	PC Board, CAN Node			TAC 50-04
<i>Photo Not Available</i>	THSN6300VG1		6300VG1	PC Board, CLW			TAC 50
	DOVR6300JC2		6300JC2 6300JC3	PC Board, CPU 16 MHz			TAC 50
	DOVR9843991	9843991	6300JC3	PC Board, CPU, 16 MHz (No Software)			TAC 50

## PC BOARDS

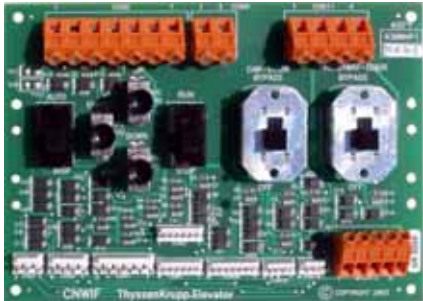

<i>NOTE: Illustrations NOT to scale.</i>	Otis Part No.	OEM Part No.	OEM Print No.	Part Description	Voltage	Symbol	System
	DOVR6300JC4	6300JC4	6300JC4	PC Board, CPU, 16 MHz (No Software) Note: Requires 675HE14 or higher generic software			TAC 50
	DOVR9845714	6300JC5	6300JC5	PC Board, CPU, 16 MHz (No Software) Note: Requires 675HE14 or higher generic software			TAC 50
<i>Photo Not Available</i>	THSN675HE14	675HE14		Generic Car Software			TAC 50
	THSN6300VF1		6300VF1	PC Board, CPU, 186C			TAC 50-04

## PC BOARDS

<i>NOTE: Illustrations NOT to scale.</i>	Otis Part No.	OEM Part No.	OEM Print No.	Part Description	Voltage	Symbol	System
	THSN6300XE1		6300XE1	PC Board, CPU, 32-Bit			TAC 50-04
<i>Photo Not Available</i>	THSN6300RV2		6300RV2	PC Board, Car Station CWIG Board			TAC 20
	DOVR6300PM1		6300PM1	PC Board, Communication Filter			TAC 20
	THSN6300NP1		6300NP1	PC Board, Controller Inspection Run Assembly		CNWIF	TAC 20

## PC BOARDS

*NOTE: Illustrations NOT to scale.*

	Otis Part No.	OEM Part No.	OEM Print No.	Part Description	Voltage	Symbol	System
	AAA26800AMW1	9782928	6300LM1	PC Board, Controller, LON, Node 24 V I/O		LN	TAC 20 TAC 50-03
<i>Photo Not Available</i>	THSN6300VT1		6300VT1	PC Board, Controller Wiring Interface (CWIK)			TAC 50-04
	THSN6300MG1		6300MG1	PC Board, Cross Connect, Interface Distributed (LON)		XCID	TAC 20
	DOVR9816975	9816975	6300LR21	PC Board, Current Regulator Board, AC/DC, 230 V, CCF			TAC 50

*PC BOARDS*

<i>NOTE: Illustrations NOT to scale.</i>	Otis Part No.	OEM Part No.	OEM Print No.	Part Description	Voltage	Symbol	System
<i>Photo Not Available</i>	DOVR6300LV2		6300LV2	PC Board, Current Regulator, Digital Brake, 10 Amp			TAC 50
<i>Photo Not Available</i>	DOVR9816628	9816628	6300LH2	PC Board, Current Sensor, 200 Amp, 30 HP			TAC 50
<i>Photo Not Available</i>	DOVR9816616	9816616	6300LH2	PC Board, Current Sensor, 150 A, 7.5–20 HP			TAC 50
<i>Photo Not Available</i>	DOVR9816872	9816872	6300LH2	PC Board, Current Sensor, 50 A			TAC 50
	THSN6300LE1		6300LE1	PC Board, Door Bypass			TAC 20

## PC BOARDS

*NOTE: Illustrations NOT to scale.*

Otis Part No.	OEM Part No.	OEM Print No.	Part Description	Voltage	Symbol	System
------------------	-----------------	------------------	------------------	---------	--------	--------



THSN2783465

2783465

PC Board,  
Drive,  
2407MC

TAC  
50-04

*Photo Not Available*

THSN6300ND1

6300ND1

PC Board,  
Drive Control,  
2407MC

TAC  
50-04

*Photo Not Available*

DOVR9841349



9841349

6300DE33

PC Board,  
DSP-SCR

TAC 50

## PC BOARDS

<i>NOTE: Illustrations NOT to scale.</i>	Otis Part No.	OEM Part No.	OEM Print No.	Part Description	Voltage	Symbol	System
	DOVR9881141	9881141	6300DE34	PC Board, DSP-VVVF, Hardware Vector			TAC 50
	DOVR9731817	9731817	6300DE35	PC Board, DSP-VVVF, Software Vector without software		DSP	TAC 50
	DOVR9839720	9839720	6300GD1	PC Board, Emergency Light, with Momentary Switch	120 VAC		TAC 20
	DOVR9867551	9867551		PC Board, Encoder Interface			Synerg y
<i>Photo Not Available</i>	THSN6300WG1		6300WG1	PC Board Fixtures Control			TAC 50

## PC BOARDS

<i>NOTE: Illustrations NOT to scale.</i>	Otis Part No.	OEM Part No.	OEM Print No.	Part Description	Voltage	Symbol	System
	THSN6300VR1		6300VR1	PC Board, Hall Node (Alt: DOVR9781146)			TAC 50-04
<i>Photo Not Available</i>	DOVR9781146	9781146		PC Board, Hall Node (Alt: THSN6300VR1)			TAC 50-04
	THSN6300MC1	9782886	6300MC1	PC Board, Hoistway Cable, Interface Centralized (non-LON)		HCIC	TAC 20
	THSN9782874	9782874	6300MF1	PC Board, Hoistway Cable, Interface Distributed (LON)		HCID	TAC 20



## PC BOARDS

*NOTE: Illustrations NOT to scale.*

Otis Part No.	OEM Part No.	OEM Print No.	Part Description	Voltage	Symbol	System
------------------	-----------------	------------------	------------------	---------	--------	--------







*6300VH1 Shown with 6300VF1 Board Attached*

DOVR9740193	9740193	6300VH3	PC Board, IOC Assembly. Replaces THSN6300VH1			TAC 50-04
-------------	---------	---------	---	--	--	--------------



THSN6300VH5		6300VH5	PC Board, IOC Assembly. Replaces THSN6300VH3			TAC 50-04
-------------	--	---------	---	--	--	--------------

## PC BOARDS

<i>NOTE: Illustrations NOT to scale.</i>	Otis Part No.	OEM Part No.	OEM Print No.	Part Description	Voltage	Symbol	System
	THSN6300LL1 Replaced by: AAA26800AMV1		6300LL1	PC Board, I/O, LON	24	L24	TAC 20 TAC 50-03
	THSN6300LL2 Replaced by: AAA26800AMV1		6300LL2	PC Board, I/O, LON	24	L24	TAC 20 TAC 50-03
	THSN6300JG1	9782813	6300JG1	PC Board, I/O Expansion (Non-LON)	24 VDC	EIO	TAC 20
	THSN6300JH1	9782825	6300JH1	PC Board, I/O Expansion (Non-LON), High Voltage, new sales or mod	24 / 48 VDC	HVIO	TAC 20

## PC BOARDS

*NOTE: Illustrations NOT to scale.*

Otis  
Part No.

OEM  
Part No.

OEM  
Print No.

Part Description

Voltage

Symbol

System



THSN6300JH2

6300JH2

PC Board,  
I/O Expansion  
(Non-LON), High  
Voltage, new sales  
or mod

115  
VAC

HVIO

TAC 20



THSN6300JH3

6300JH3

PC Board,  
I/O Expansion  
(Non-LON), High  
Voltage, new sales  
or mod

230  
VAC

HVIO

TAC 20

## PC BOARDS

*NOTE: Illustrations NOT to scale.*

Otis  
Part No.

OEM  
Part No.

OEM  
Print No.

Part Description

Voltage

Symbol

System



AAA26800AMV1

9782916

6300LL3

PC Board,  
I/O Expansion, with  
LED, LON

24 V

L24

TAC 20  
TAC  
50-03



~~THSN6300RE1~~  
Replaced by:  
THSN6300RE3

~~6300RE1~~  
6300RE3

PC Board,  
IOA

IOA

TAC  
20-03

*Photo Includes 6300RD2 Processor Board and  
Owner Service Tool (OST)*



DOVR6300PN1



CE2677A1

6300PN1

PC Board,  
Interface

TAC 20  
TAC 50

## PC BOARDS

<i>NOTE: Illustrations NOT to scale.</i>	Otis Part No.	OEM Part No.	OEM Print No.	Part Description	Voltage	Symbol	System
	THSN9816446	9816446	6300HC3	PC Board, Interface 80/12/160 HP			TAC 50
	DOVR9816446	9816446	6300HC2	PC Board, Interface, 80 / 120 HP			TAC 50
<i>Photo Not Available</i>	DOVR9816380	9816380	6300FK1, 6300FK2	PC Board, Inverter Interface			TAC 50
	DOVR9816689	9816689	6300LF1, 6300LF2	PC Board, Inverter Interface, 3/00 REV (6 Pack)			TAC 50
<i>Photo Not Available</i>	DOVR9816458	9816458	6300HD3	PC Board, Inverter Snubber, 80/120 HP			TAC 50
<i>Photo Not Available</i>	DOVR9773204	9773204	6300RK24	PC Board, LED			TAC 50

## PC BOARDS

*NOTE: Illustrations NOT to scale.*

Otis Part No.	OEM Part No.	OEM Print No.	Part Description	Voltage	Symbol	System
------------------	-----------------	------------------	------------------	---------	--------	--------

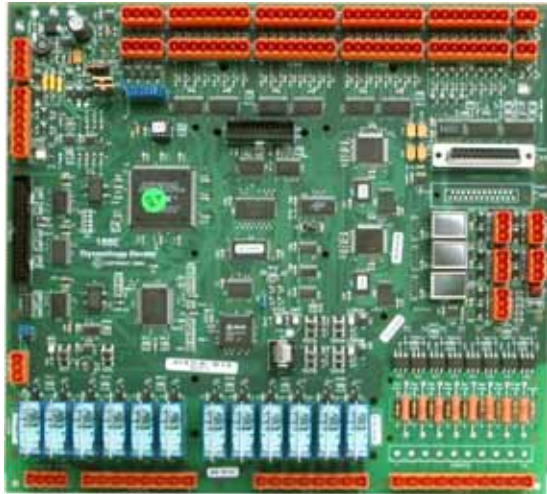

D0VR9782552

9782552

6300KY4,  
6300KY7

PC Board,  
Main Processor  
CPU,  
LON-based, Multi-  
Car Group

188E

TAC 20

**PROPRIETARY**

Refer to SDC  
Customer Text

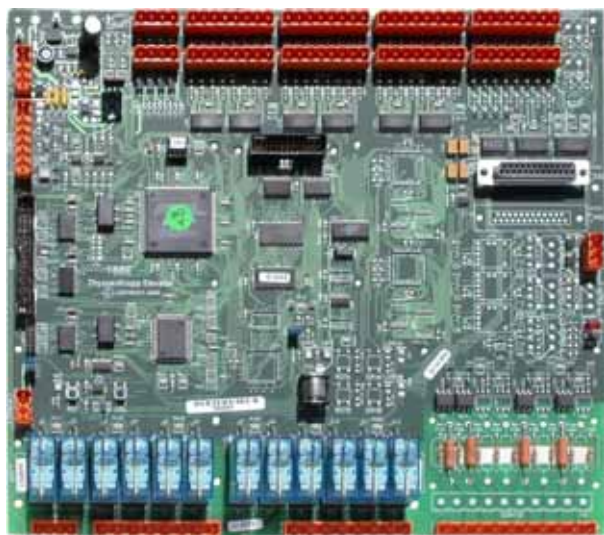

THSN6300KY9

9782576



6300KY6,  
6300KY9

PC Board,  
Main Processor  
CPU, Single Car  
without LON

188E

TAC 20

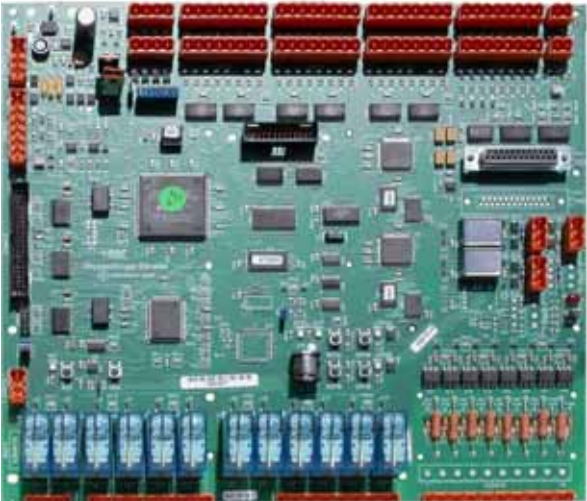
## PC BOARDS

<i>NOTE: Illustrations NOT to scale.</i>	Otis Part No.	OEM Part No.	OEM Print No.	Part Description	Voltage	Symbol	System
<i>Photo Not Available</i>	DOVR9782576	9782576	6300KY9	PC Board, Main Processor CPU, Single Car without LON Will replace THSN6300NY9 when stock depletes.		188E	TAC 20
	DOVR9782564	9782564	6300KY5, 6300KY8	PC Board, Main Processor CPU, Single Car, with LON <hr/> <b>PROPRIETARY</b> Refer to SDC Customer Text		188E	TAC 20
	THSN6300MJ3		6300MJ3	PC Board, Main Sensor, Tape Selector, High Resolution, Tape Reader		TSM	TAC 20

## PC BOARDS

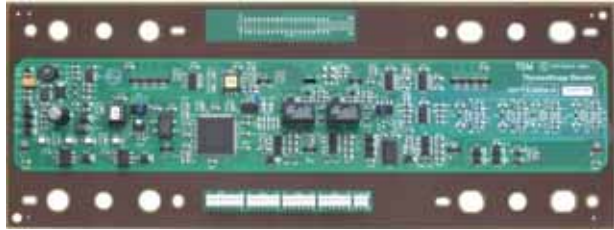
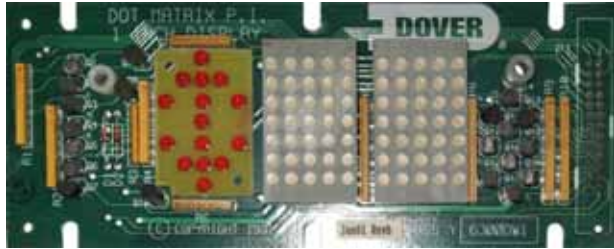
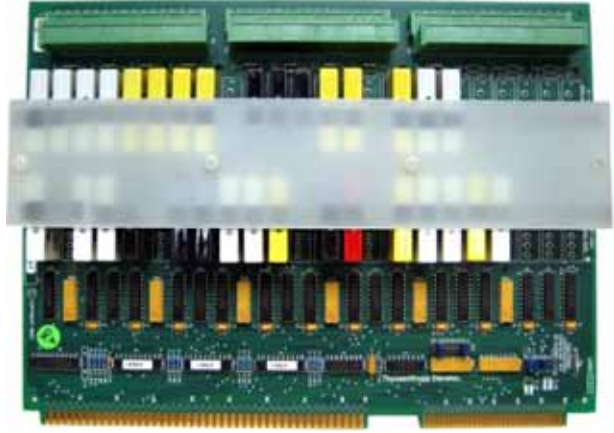
<i>NOTE: Illustrations NOT to scale.</i>	Otis Part No.	OEM Part No.	OEM Print No.	Part Description	Voltage	Symbol	System
	THSN9782849	9782849	6300MJ4	PC Board, Main Sensor, Tape Selector, Low Resolution, Tape Reader		TSM	TAC 20
<i>Photo Not Available</i>	DOVR9816094	9816094	6300KB1	PC Board, Mother Board, Car and Group			TAC 50
	DOVR9830431		6300DW1	PC Board, PI, Dot Matrix			TAC 50
	DOVR9863000	9863000	6300CN5	PC Board, PMI 48 I/O			TAC 50
<i>Photo Not Available</i>	THSN9815600	9815600	6300NA1	PC Board, Processor		186LC	TAC 50-03



## PC BOARDS

*NOTE: Illustrations NOT to scale.*

Otis  
Part No.

OEM  
Part No.

OEM  
Print No.

Part Description

Voltage

Symbol

System



THSN6300RD3

6300RD3

PC Board,  
Processor

1860

TAC  
20-03

*Shown with Owner Service Tool (OST)*

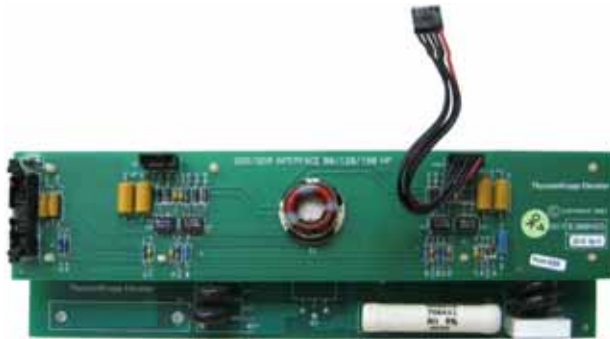

THSN9816471

9816471

6300HG5

PC Board,  
QSS/QSR Interface,  
80/120/160 HP

TAC 50

*Shown Mounted Above 6300HJ3.*



DOVR9816392



9816392

6300FV2  
6300FV3





PC Board,  
QSS/QSR Inverter  
Interface

TAC 50

## PC BOARDS

<i>NOTE: Illustrations NOT to scale.</i>	Otis Part No.	OEM Part No.	OEM Print No.	Part Description	Voltage	Symbol	System
 <p><i>Shown with 6300HG5 Board Mounted Above.</i></p>	THSN9816483	9816483	6300HJ3	PC Board, QSS/QSR Snubber			TAC 50
<i>Photo Not Available</i>	DOVR9755470	9755470	6300FP1	PC Board, QSS/QSR Snubber, 230 V			TAC 50
<i>Photo Not Available</i>	DOVR9816586	9755470	6300FP2	PC Board, QSS/QSR Snubber, 230 V			TAC 50
<i>Photo Not Available</i>	DOVR9734715	9734715	6300ET2	PC Board, Regulator, High Armature Voltage, >361 V			TAC 50
<i>Photo Not Available</i>	DOVR9734612	9734612	6300ET1	PC Board, Regulator, Low Armature Voltage, <360V			TAC 50
	THSN6300NC1		6300NC1	PC Board, Relay Rectifier			TAC 20

## PC BOARDS

<i>NOTE: Illustrations NOT to scale.</i>	Otis Part No.	OEM Part No.	OEM Print No.	Part Description	Voltage	Symbol	System
	THSN6300NR1		6300NR1	PC Board, Repeater Board, LON			TAC 20 TAC 50-03
<i>Photo Not Available</i>	THSN6300VC1		6300VC1	PC Board Assembly, S24-1			TAC 50-04
<i>Photo Not Available</i>	THSN6300VL1		6300VL1	PC Board Assembly, S24-2			TAC 50-04
	THSN6300TX2	9740375	6300TX2	PC Board, SPI, High Voltage			TAC 20 TAC 50 HD-03 HD-04 Door Op. I/O
	THSN9816460	9816460	6300HD4	PC Board, Snubber, 80/120/160 HP			TAC 50 TAC 50-04
	THSN9848101	9848101	6300HE1	PC Board, Switching Power Supply, 80/120 HP			TAC 50





## PC BOARDS

<i>NOTE: Illustrations NOT to scale.</i>	Otis Part No.	OEM Part No.	OEM Print No.	Part Description	Voltage	Symbol	System
	THSN6300ME1	9782862	6300ME1	PC Board, Traveling Cable, Interface Centralized (non-LON)		HCIC	TAC 50-03
	THSN9782898	9782898	6300MD1	PC Board, Traveling Cable, Interface Distributed (LON)		TCID	TAC 50-03
	THSN6300HL1		6300HL1	PC Board, User Interface Tool			TAC 20 TAC 50 TAC 50-03 TAC 50-04
	THSN6300MA1		6300MA1 6300MA2	PC Board, Wiring Interface, Car, Centralized (non-LON)		CWIC	TAC 20
	THSN6300MB1		6300MB1	PC Board, Wiring Interface, Car, Distributed Card (LON)		CWID	TAC 20



## PC BOARDS

<i>NOTE: Illustrations NOT to scale.</i>	Otis Part No.	OEM Part No.	OEM Print No.	Part Description	Voltage	Symbol	System
	THSN6300JL2		6300JL2	PC Board, Wiring Interface, Controller		CNWI	TAC 20
<i>Photo Not Available</i>	DOVR9816124			Power Supply, PS2	PS2		TAC 50
<i>Photo Not Available</i>	DOVR9719234	9719234	6300DK1	Regulator Kit, Position Encoder, Contains Regulator Card, Brackets & Hardware			TAC 50



## POSITION INDICATOR EQUIPMENT

<i>NOTE: Illustrations NOT to scale.</i>	Otis Part No.	OEM Print No.	Part Description	Symbol	System
	THSN9782801	6300KP1	Position Indicator Controller, LON	LPIC	TAC 20
	THSN6300KW1	6300KW1	Position Indicator Display, 16-Segment, LON	LPID	TAC 20 TAC 50
	THSN9782904	6300KR1	Position Indicator Display, 5 x 7 LED Matrix, LON	LPID	TAC 20
	THSN6300KX1	6300KX1	Position Indicator Display, 5 x 7 LED Matrix, LON	LPID	TAC 20 TAC 50
<i>Photo Not Available</i>	THSN6300rm24	6300RM24	Position Indicator Display		TAC 20
<i>Photo Not Available</i>	THSN6300WR3	6300WR3	Position Indicator, Serial		TAC 50-04

## POWER SUPPLY / BATTERIES

<i>NOTE: Illustrations NOT to scale.</i>	Otis Part No.	OEM Part No.	Part Description	Symbol	Voltage	Amp Hours	System
	COMMPS-1212	116AB2	Battery, Back-Up		12 V	1.2	TAC 50-04
	THSN116AH1	CR-1/3N, 2L76, 116AH1	Battery, Lithium	BAT1	3 V	160 m	TAC 20 188E
<i>Photo Not Available</i>	THSN116AM1	116AM1	Battery, Lithium		3 V	220 mAH	TAC 20
	DOVR116AB1	PS-130; BP3-12; RB1230	Battery, OEM Print No. 116AB1		12 V	3	TAC 50
<i>Photo Not Available</i>	COMMRBC2	RBC2	Battery, Sealed Lead Acid. For APC Back-UPS ES UPS.	ES	12 V	7.0	TAC 20

## POWER SUPPLY / BATTERIES



<i>NOTE: Illustrations NOT to scale.</i>	Otis Part No.	OEM Part No.	Part Description	Symbol	Voltage	Amp Hours	System
	COMMRBC32	RBC32	Battery, Sealed Lead Acid. For APC Back-UPS RS UPS.	RS	12 V	13.6	TAC 20
<i>Photo Not Available</i>	COMMBP5.5-12RT	RB1255R T	Battery, Sealed Lead Acid. For Superior Electric SEM- series UPS.		12 V	4.08	TAC 20
	AAA718E14	LC-R127 NP7-12	Battery, Sealed Lead Acid. For Superior Electric SPW- series UPS.		12 V	7.0	TAC 20
<i>Photo Not Available</i>	THSN6300TA1	6300TA1	Charger, Emergency Light Battery.				TAC 20





## POWER SUPPLY / BATTERIES

<i>NOTE: Illustrations NOT to scale.</i>	Otis Part No.	OEM Part No.	Part Description	Symbol	Voltage	Amp Hours	System
<i>Photo Not Available</i>	DOVR9816112	9816112	Power Supply, 20 A, PS1 OEM Print No. 672BF2		+5 V		TAC 50
	COMMMAP55-4003 DOVR9835246	MAP55-4003 9835246	Power Supply, OEM Print No. 672BM3		+/- 5 & 15 VDC		TAC 50
<i>Photo Not Available</i>	DOVR9816161	9816161	Power Supply, 1.5 A, PS4 OEM Print No. 672BH1		+/- 15 V		TAC 50
<i>Photo Not Available</i>	DOVR9816136	9816136	Power Supply, 150 W, 6.3 A, PS3 OEM Print No. 672BY1		24 V		TAC 50
<i>Photo Not Available</i>	DOVR9816148	9816148	Power Supply, 150 W, 32 A, PS3 OEM Print No. 672CC1		48 V		TAC 50



## POWER SUPPLY / BATTERIES

<i>NOTE: Illustrations NOT to scale.</i>	Otis Part No.	OEM Part No.	Part Description	Symbol	Voltage	Amp Hours	System
 <p>A tall, beige tower-style UPS unit with a CD-ROM case and cables in front of it.</p>	COMMBACKUPSR1000	BR1000	Power Supply (UPS), Uninterruptible, 600 Watts, Back-UPS	RS 1000	1000 VA		TAC 20
 <p>A smaller, black desktop-style UPS unit with a yellow 'STOP' warning label and a power cord.</p>	COMMBACKUPSES500	BE500R	Power Supply (UPS), Uninterruptible, Back-UPS, 300 W	ES 500	500 VA		TAC 20

## SERVICE TOOL

<i>NOTE: Illustrations NOT to scale.</i>	Otis Part No.	OEM Part No.	OEM Print No.	Part Description	Symbol	System
	AAA174RC1	EVMBMC-0010-FM		Cable, AT Modem, Premium, DB9 Female/DB25 Male, 9-Conductor, 24 AWG. Required for use with the Otis service tool for TAC systems.		TAC 20 TAC 50
	AAA174RA1	AK125-2 CMZ6-IBM		Cable, Molded AT Modem, DB25 Male / DB9 Female, 6 ft. Required for use with the Otis service tool for TAC systems.		TAC 20 TAC 50
<i>Photo Not Available</i>	AAA174ALB1			Cable, Programming. For A_A26800AMW boards. Required for use with the OSTT.		TAC 20 TAC 50
<i>Photo Not Available</i>	AAA174RA2			Cable, Serial DB9M to DB9F; 6 ft.		TAC 50-04
	THSNUSBFLASH DRIVE			Flash Drive, USB. For archiving system files on all TAC products.		TAC 20 TAC 50

*SERVICE TOOL*

<i>NOTE: Illustrations NOT to scale.</i>	Otis Part No.	OEM Part No.	OEM Print No.	Part Description	Symbol	System
	AAA27BT30	75010		Interface. LonWorks Technology U10 USB Network Interface		TAC 20 TAC 50
	AAA27BT29			Service Tool (Otis service tool for TAC systems)		TAC 20 TAC 50
	THSN6300PE1		6300PE1	Service Tool (Owner's Service Tool) <b>NOTE:</b> OEM job no. or serial no. is required to order this part.	OST	TAC 20 TAC 50

## SERVICE TOOL

<i>NOTE: Illustrations NOT to scale.</i>	Otis Part No.	OEM Part No.	OEM Print No.	Part Description	Symbol	System
	THSN9850101	9850101	850TA1	TLS Module Used for the Thyssen Accord Drive		